

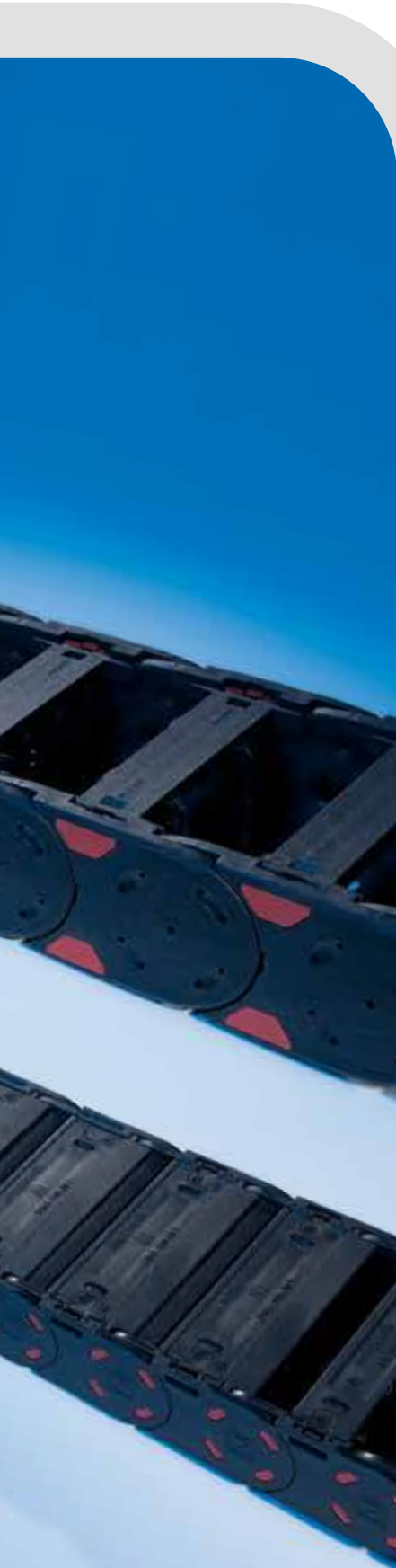

# Cable drag chain systems







**EasyLine cable drag chains**  
Simple filling with the Easy mechanism

**from page 62**

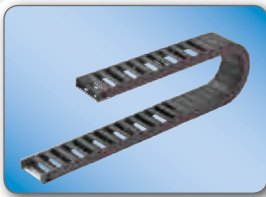

**MultiLine cable drag chains**  
Compact dimensions, can be supplied in open and closed designs

**from page 68**



**ModulLine cable drag chains**  
Extensive shelving system/interior division, can be supplied in open and closed designs, quiet running

**from page 162**



**PowerLine cable drag chains**  
Opens on both sides, for high additional loads and long travel distances, open and closed designs available, variable widths via aluminium crossbars

**from page 186**



**HeavyLine cable drag chains**  
Very high tensile strength, for high additional loads and long travel distances, opens on both sides, variable widths via aluminium crossbars

**from page 290**



**Murrplastik legacy products**  
*(do not use for new-build projects)*  
Tried-and-tested ranges, still in stock, not to be used for new-build projects

**from page 330**



**Strain relief systems**  
Strain relief and Steel Fix bow clamps

**Page 421**



**Appendix**  
Protection classes, fire classifications, directives, chemical resistances and other information

**Page 431**



Catalogue overview . . . . .	Page	7
Table of Contents . . . . .	Page	8 – 9
Success doesn't happen overnight– over 30 years of passion for innovation . . . . .	Page	10 – 11
Click lock – Click - and you're done . . . . .	Page	12
Flexible shelving system . . . . .	Page	13
Variable crossbars and covers . . . . .	Page	14
The best connections . . . . .	Page	15
Integrated strain relief – Economic on time and space . . . . .	Page	16
Bracket bar . . . . .	Page	17
Increased service life of the chain in gliding applications . . . . .	Page	18
Gliding plates for side-mounted position . . . . .	Page	19
Noise damping system . . . . .	Page	20
Guide channels VAW with damper . . . . .	Page	21
Guide channel VAW . . . . .	Page	22
Confectioning connect4motion . . . . .	Page	23
Atex cable drag chains . . . . .	Page	24
Electrostatic discharges . . . . .	Page	25
Clean room cable drag chains . . . . .	Page	26
Visual differentiation . . . . .	Page	27
Corporate Identity – Individual cable drag chain identification . . . . .	Page	28
Selection criteria for cable drag chains . . . . .	Page	29
Selection tables . . . . .	Page	30 – 35
Installation options of cable drag chains . . . . .	Page	36
Cable drag chain system planning form . . . . .	Page	37 – 38
Cable drag chain cable request form . . . . .	Page	39
Cable confectioning form . . . . .	Page	40
Glossary . . . . .	Page	41 – 43
Cable drag chain systems sorted by interior height . . . . .	Page	44 – 61

**CABLE DRAG CHAIN SYSTEMS**

<b>Product line</b>	<b>Type</b>	<b>Variation</b>	<b>Inside width</b>		
<b>EasyLine</b>	MP 10.1	open	10 mm . . . . .	Page	62 – 67
<b>MultiLine</b>	MP 14	open	14 mm . . . . .	Page	68 – 73
<b>MultiLine</b>	MP 15	open	14 mm . . . . .	Page	74 – 79
<b>MultiLine</b>	MP 18.1/MP 18.2	open	18 mm . . . . .	Page	80 – 85
<b>MultiLine</b>	MP 18.4	open	18 mm . . . . .	Page	86 – 91
<b>MultiLine</b>	MP 20.2	open	20 mm . . . . .	Page	92 – 97
<b>MultiLine</b>	MP 3000	open	26 mm . . . . .	Page	98 – 105
<b>MultiLine</b>	MP 25G	open	25 mm . . . . .	Page	106 – 113
<b>MultiLine</b>	MP 35.1/MP 35.2	open	35 mm . . . . .	Page	114 – 125
<b>MultiLine</b>	MP 36G	open	36 mm . . . . .	Page	126 – 133
<b>MultiLine</b>	MP 43G	open	38 mm . . . . .	Page	134 – 141
<b>MultiLine</b>	MP 45.1/MP 45.2	open	45 mm . . . . .	Page	142 – 153
<b>MultiLine</b>	MP 65G	open	60 mm . . . . .	Page	154 – 161
<b>ModulLine</b>	MP 25.1/.2	open	25 mm . . . . .	Page	162 – 173
<b>ModulLine</b>	MP 25.3/.4	closed	25 mm . . . . .	Page	162 – 173
<b>ModulLine</b>	MP 30.1/.2	open	30 mm . . . . .	Page	174 – 185
<b>ModulLine</b>	MP 30.3/.4	closed	30 mm . . . . .	Page	174 – 185
<b>PowerLine</b>	MP 32.2	open	32 mm . . . . .	Page	186 – 201
<b>PowerLine</b>	MP 32.3	closed	30 mm . . . . .	Page	186 – 201
<b>PowerLine</b>	MP 41.2	open	42 mm . . . . .	Page	202 – 217
<b>PowerLine</b>	MP 41.3	closed	38 mm . . . . .	Page	202 – 217
<b>PowerLine</b>	MP 52.2	open	52 mm . . . . .	Page	218 – 233
<b>PowerLine</b>	MP 52.3	closed	48 mm . . . . .	Page	218 – 233
<b>PowerLine</b>	MP 52.2-D	open	52 mm . . . . .	Page	234 – 249
<b>PowerLine</b>	MP 52.3-D	closed	48 mm . . . . .	Page	234 – 249
<b>PowerLine</b>	MP 52.4	open	52 mm . . . . .	Page	250 – 265
<b>PowerLine</b>	MP 52.5	closed	48 mm . . . . .	Page	250 – 265

PowerLine	MP 52.6	open	52 mm . . . . .	Page	266 – 275
PowerLine	MP 52.7	closed	48 mm . . . . .	Page	266 – 275
PowerLine	MP 62.4	open	62 mm . . . . .	Page	276 – 289
HeavyLine	MP 62.2	open	62 mm . . . . .	Page	290 – 303
HeavyLine	MP 62.3	closed	62 mm . . . . .	Page	290 – 303
HeavyLine	MP 82.2	open	82 mm . . . . .	Page	304 – 317
HeavyLine	MP 82.3	closed	74 mm . . . . .	Page	304 – 317
HeavyLine	MP 102.2	open	104 mm . . . . .	Page	318 – 329
<b>Murrplastik legacy products (do not use for new-build projects)</b>					
Legacy	MP 32	open	32 mm . . . . .	Page	330 – 343
Legacy	MP 35	open	34 mm . . . . .	Page	344 – 351
Legacy	MP 41	open	42 mm . . . . .	Page	352 – 365
Legacy	MP 44	open	40 mm . . . . .	Page	366 – 373
Legacy	MP 52.1	open	52 mm . . . . .	Page	374 – 387
Legacy	MP 62.1	open	62 mm . . . . .	Page	388 – 399
Legacy	MP 66	open	60 mm . . . . .	Page	400 – 407
Legacy	MP 72	open	72 mm . . . . .	Page	408 – 419

**STRAIN RELIEF SYSTEMS**

Introduction . . . . .	Page	422 – 423
Benefits . . . . .	Page	424 – 425
Selection criteria/ Guide to system design . . . . .	Page	426
Design / Structure . . . . .	Page	427
Strain relief system type ZL-C set and type ZL . . . . .	Page	428
Strain relief system type ZL/ double strain relief system . . . . .	Page	429
Steel Fix bow clamp . . . . .	Page	430

**APPENDIX**

Protection classes DIN EN 60529 . . . . .	Page	432
Fire classification according to UL 94, DIN 5510 . . . . .	Page	433
Material characteristics . . . . .	Page	434 – 435
Information about materials . . . . .	Page	436 – 437
Chemical resistances of plastics . . . . .	Page	438 – 439

# SUCCESS DOESN'T HAPPEN OVERNIGHT



## A SELECTION OF OUR INNOVATIONS FOR YOUR ADVANTAGE:

- 1984** First cable drag chain that can be opened
- 1987** Crossbars pivotable on both sides
- 1988** Bayonet stop system
- 1994** Integrated strain relief plate
- 1994** Guide channel system with releasable connecting glide rails
- 1996** Center piece for guide channel systems aligned in parallel
- 1997** Guide channel system with multiple grooves
- 1998** Crossbar connectors for greater stability with large chain widths
- 2001** PowerLine 2nd Generation Generation
- 2002** PowerLine shelving system for optimised chain compartment
- 2003** Magnet chain technology for non-contact gliding
- 2005** MultiLine series
- 2007** Brush supports for optimum cable positioning in the neutral strand
- 2008** ModulLine series
- 2011** Bracket bar for integration of large-diameter media conduits into an cable drag chain system
- 2013** Sliding blocks for higher service life of the chain
- 2015** PowerLine MP 52.6 for long travel distance
- 2016** PowerLine light series
- 2016** noiseLESS guide channel system
- 2016** MultiLine MP 45 with additional damper option
- 2017** Gliding plates for Power- and HeavyLine

# OVER 30 YEARS OF PASSION FOR INNOVATION



[www.mp.de](http://www.mp.de)

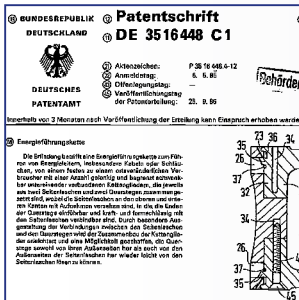

1984



1987



1988



1994

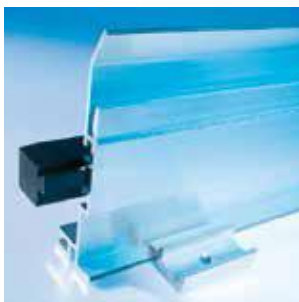

1994



2000



2003

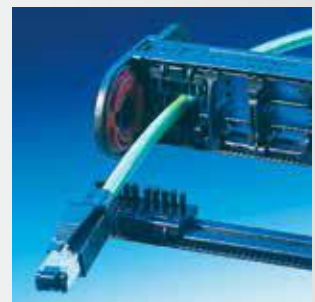

2007



2008



2011



2013



2015



2016



2016



2016



2017

# CLICK LOCK CLICK – AND YOU’RE DONE



## FAST AND EASY

The crossbars can be fitted and removed quickly and with very little effort. Position the screwdriver between side link and crossbar and slightly turn it to open the click lock. Retrofitting a cable in the cable drag chain is also a quick and simple task. Assembly is even simpler. Position the crossbar in the side links and lock the click lock by hand.

With the click lock it is child’s play. Fitting and removal are rarely quicker or simpler without compromising stability.



- Quick assembly: click and go!
- REFA time and motion study conducted
- Assembly without tools
- Easy assembly
- Incredibly simple to retrofit cables



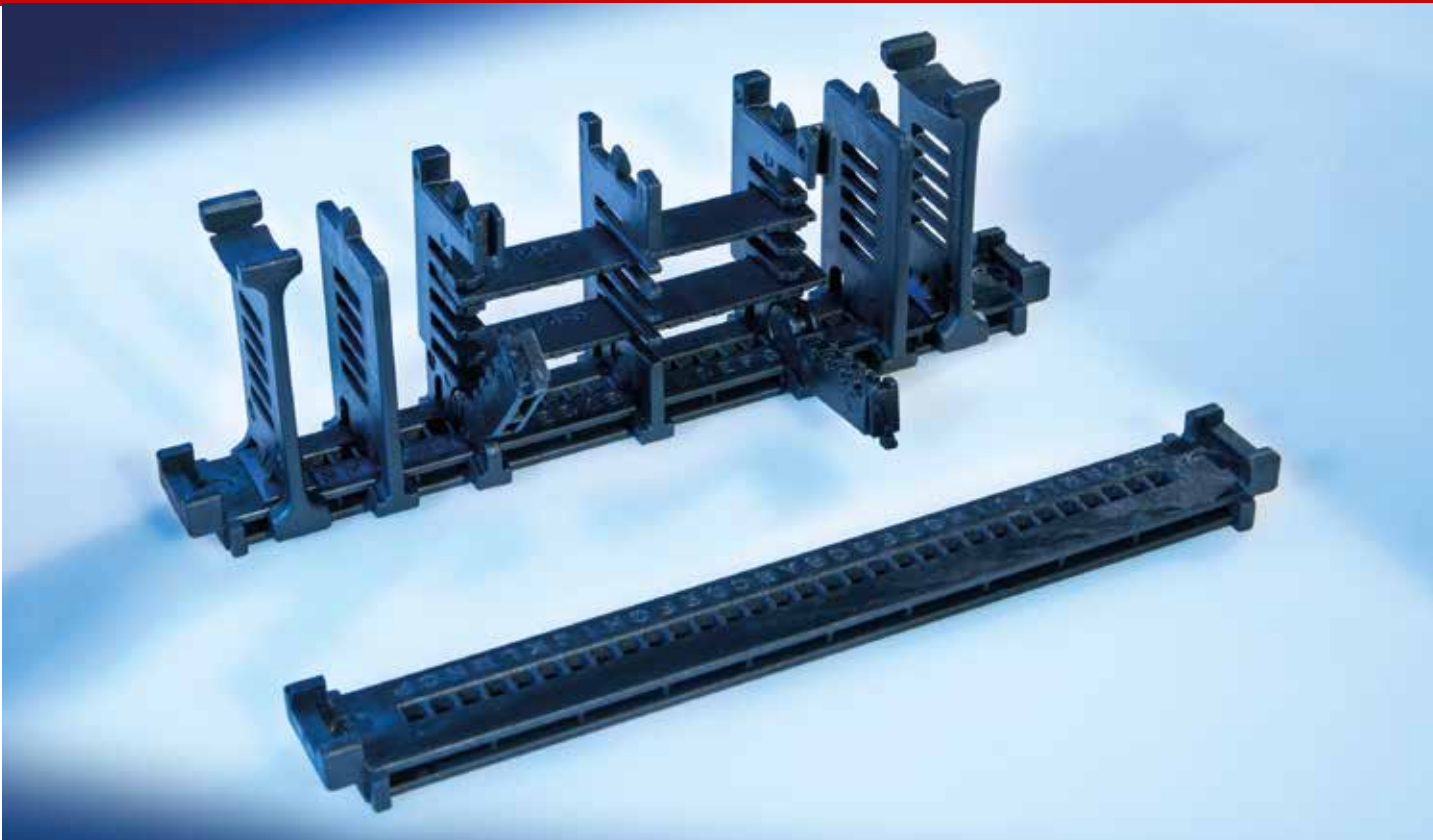

## EXTREMELY VERSATILE

Equipping the chain with cables is made simpler by using separable shelf supports

The multitude of combination options means that the perfect shelving system can be put together for any application.

The shelf separators lock firmly into the crossbars and, once in place, they cannot slip. No matter what type of installation – horizontal, backwards, etc. – the cables stay in the position that was originally intended. This means: a long service life and no uneven wear to the chain.



- Easy assembly
- REFA time and motion study conducted
- Lockable separator, fixed position
- Rapid assembly
- Modifications possible when installed

# VARIABLE CROSSBARS AND COVERS



## VARIABLE

Crossbars/covers come in two alternative versions: plastic or aluminium. The plastic version is standard for crossbars and can be supplied in a range of widths. The aluminium version can be supplied in any width.

## FIXED

In both the plastic and the aluminium versions, the separators lock into the crossbar/cover and are thus fixed in place. The separators remain in their original position regardless of the type of installation and any chain movement. The crossbars and separators form a stable unit.



- Flexible adjustment due to closely spaced lock tabs
- Fixed with lock tabs
- Variable length
- Extremely stable

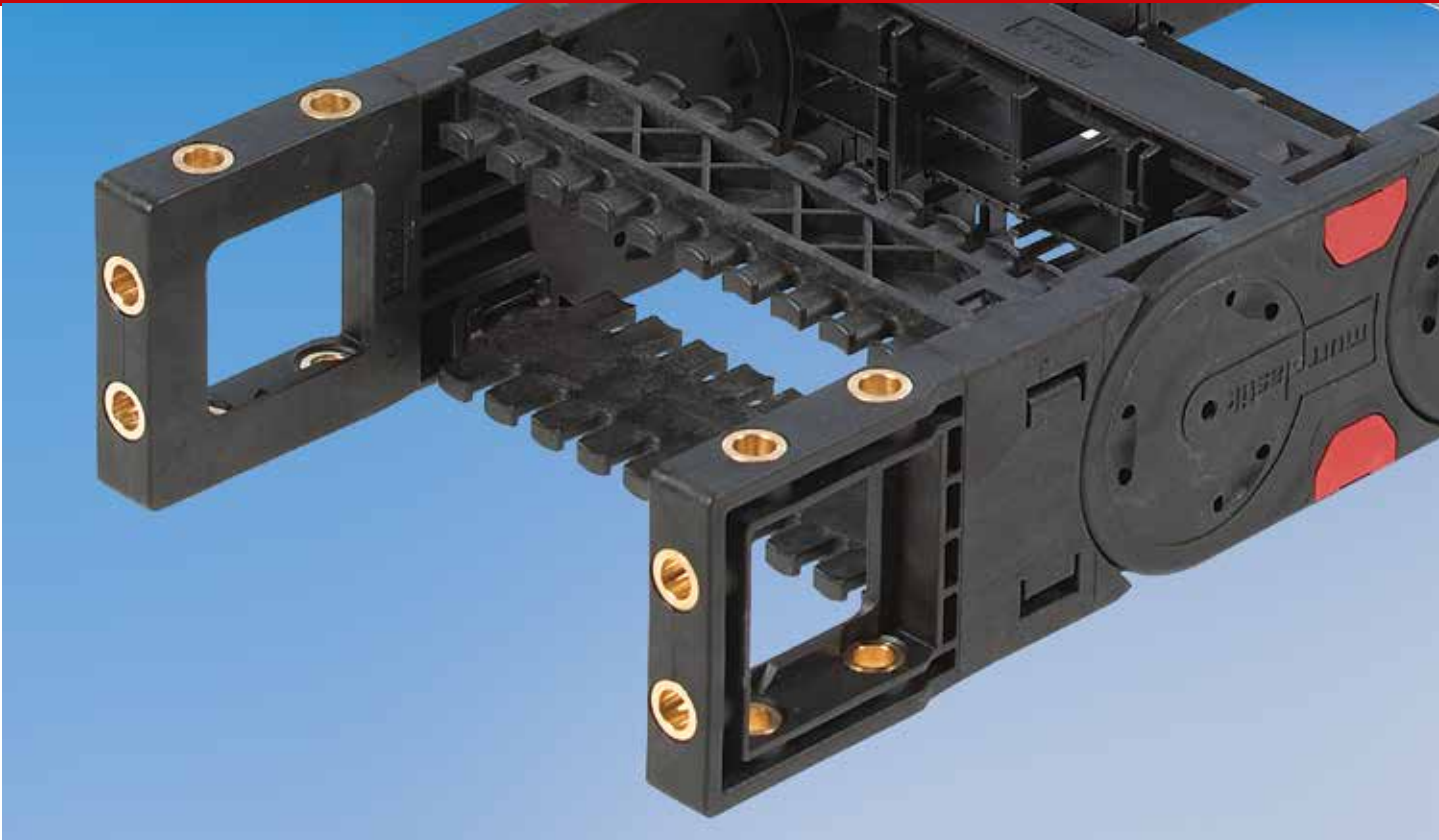

## FAST AND EASY TO ASSEMBLE

Metal bushes are injected permanently into the plastic in the chain bracket. There are two types of bushings: with our without thread. The bushings are offered without thread as standard.

Both types of bush inhibit cold flow properties during screwing, thus effecting an extremely good fit. The threaded bush is screwed directly without a nut.



- No cold flow deformation
- Quick
- Secure fastening
- Compact

# INTEGRATED STRAIN RELIEF SAVES TIME AND SPACE



## SIMPLE AND SAFE STRAIN RELIEF

No cumbersome special design for cable strain relief. Everything is quick and safe with the Murrplastik cable drag chain system.

Special strain relief crossbars are used on the chain bracket. The strain relief is effected by cable ties. The cable can be fixed on the strain relief plate on two sides.

This integrated strain relief system is very quick to assemble and is extremely economical on space.

The Steel Fix bow clamps are mounted on the C-rail integrated into the chain bracket. This strain relief mechanism is impressively easy to fit and very secure. One Steel Fix bow clamp can provide strain relief for up to three cables.



- Easy to assemble
- Compact design
- Economical
- Saves space
- Secure strain relief



## INTEGRATION OF MEDIA CONDUITS

Large-diameter conduits are routed securely by using bracket bars. These bracket bars can be supplied in various sizes.

Mounting is either on the crossbars or on the closed cover. Thanks to the modular design, retrofitting with bracket bars is also possible at any time.

### Bracket bars are available for the following cable drag chains:

MP 32.2 / MP 32.3 ALU

MP 41.2 / MP 41.3

MP 52.2 / MP 52.3 / MP 52.4 / MP 52.5

MP 62.2 / MP 62.3 / MP 62.4 / MP 62.5 ALU

MP 82.2 / MP 82.3



- Modular system
- Available for crossbars and covers
- Can be supplied in a range of sizes
- Can be retrofitted

# EXTENSION OF THE SERVICE LIFE OF THE CABLE DRAG CHAIN IN GLIDING APPLICATION



## SLIDING BLOCKS - INNOVATION AGAINST WEAR AND TEAR

Cable drag chains that are used in horizontal gliding applications, with travel of longer than three meters, are often subjected to very high mechanical loads.

Murrplastik Systemtechnik has developed a simple and clever solution to address this problem: the sliding block. The sliding blocks are fitted onto the side links in the cable drag chain's inside bend without the need for any kind of tools. A screwdriver may be needed merely to disengage a sliding block for removal. As a result, when the wear limit is reached, only the comparatively inexpensive sliding blocks have to be replaced and not the complete cable drag chain.

Practical tests show that cable drag chains can gain as much as a fivefold extension to their service life by using sliding blocks. An investment that pays for itself in a very short time.



WITH SLIDING BLOCK



WITHOUT SLIDING BLOCK

**Sliding blocks are available for the following cable drag chains:**

MP 32.2 / MP 32.3 ALU  
MP 41.2 / MP 41.3  
MP 52.2 / MP 52.3 / MP 52.4 / MP 52.5  
MP 62.2 / MP 62.3 / MP 62.4 / MP 62.5 ALU  
MP 82.2 / MP 82.3

- Wear-reducing
- Extension of the service life by up to five times
- Easy assembly and disassembly
- Interchangeable

# GLIDING PLATES FOR HORIZONTAL SIDE-MOUNTED POSITION



www.mp.de



## GLIDING PLATES – CONTROLLED WEAR

Gliding plates are used with cable drag chains in horizontal side-mounted position. The gliding plates are snapped into the side links instead of using side link locks (GLP 8 and GLP 10, no tools required) or they are screwed directly to the side links (GLP 4 and GLP 5).

This allows the cable drag chain to slide on the gliding plates and not on the side links. Depending on the application, the service life of the cable drag chain may be extended two-fold, by using slide plates.

The wear limit for all gliding plates is 2.5 mm. Once the wear limit is reached, the material thickness on the sliding surface of the gliding plate is 4.5 mm. We recommend replacing the cable drag chain when this limit has been reached.



GLP 5 SLIDE PLATE



GLP 8 SLIDE PLATE

**Gliding plates are available for the following cable drag chains:**

MP 41.2 / MP 41.3  
MP 52.2 / MP 52.3 / MP 52.4 / MP 52.5  
MP 62.4 / MP 62.5 ALU  
MP 82.2 / MP 82.3 / MP 102.2

- Doubling of the service life
- Runs more quiet through significantly reduced polygon effect.
- Cable drag chain can also be opened in side-mounted position
- For GLP 8 and GLP 10 no tool required
- Cable drag chains are supplied completely mounted with the gliding plates

# NOISE REDUCTION SYSTEM



## NOISE REDUCTION SYSTEM

Thanks to the innovative development of the damping elements the noise emission can be reduced by up to 10 dB(A) compared to conventional cable drag chains without damper.

The integrated damping elements function in the inside bend stops and facilitate a significantly quieter unrolling of the chain links.

Since a noise reduction by 10 dB(A) is already perceived as half the noise emission, it is therefore considered a much quieter environment, conducive to concentrated work.

The damping elements are available for the cable drag chain series MP 35.1/MP 35.2, MP 45.1/MP 45.2, MP 52.2-D/MP 52.3-D, MP 52.4/ MP 52.5, MP 62.4/ MP62.5 ALU.



- Reduction of the noise emission by up to 10 dB(A)
- Significantly quieter unrolling of the chain links.
- Completely assembled system



# GUIDE CHANNELS VAW WITH DAMPER



## REDUCTION OF THE NOISE EMISSION

The use of cable drag chains generates considerable noise, especially at higher speeds. The reason for this is the non-circular rolling of the cable drag chain links on the surface – the so-called polygon effect.

As a solution to reduce the noise emission Murrplastik offers variable guide channel systems with integrated damping elements. This reduces disturbing noise by up to 20 dB(A)

Available variants:

VAW 146, noiseLESS NL30, noiseLESS NL35

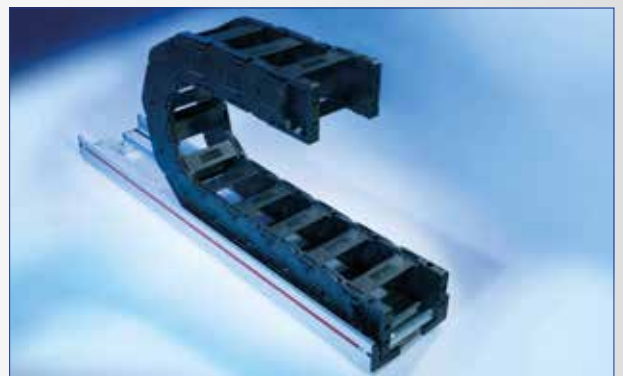

- Reduction of the noise emission by up to 20 dB(A)
- Quick and easy assembly
- Salt-water resistant and corrosion proof
- Variable chain widths

# VAW GUIDE CHANNELS



## VAW GUIDE CHANNELS - FOR MAXIMUM SPEED ASSEMBLY

The VAW variable guide channel system is harmonised for Murrplastik cable drag chains. Since different applications require different materials, the guide channels are made of galvanized steel, stainless steel or aluminium. We can also supply V4a models on request for saltwater applications.

No screwing or welding is required for the individual sections in our variable guide channel system. The channel sections are perfectly aligned thanks to special plastic connectors or channel brackets. The floor mounting is made with clamping pieces and C-rails.

The glide rail profile not only guarantees snag-free gliding for the cable drag chain over the entire travel distance, but also reduces the noise level.



- Quick and easy assembly
- High quality
- Highly economical
- Tailored system
- Long service life

# CONFECTIONING CONNECT 4 MOTION



[www.mp.de](http://www.mp.de)



## EVERYTHING FROM ONE SOURCE

Reduce your labour costs and save time by taking advantage of our experience in chain systems gained over many years.

At the customer's request we assemble complete cable drag chains with cables. We handle the layout, assembly and ordering of individual components. The customer is supplied with a complete assembly kit that only needs to be fitted.

Thanks to our experience of cable drag chains and cables acquired over many years, we can combine both elements in one system. This guarantees a long service life.



- System guarantee
- Easy handling
- Saves time and hassle when ordering
- Reduced warehousing costs

# ATEX CABLE DRAG CHAINS

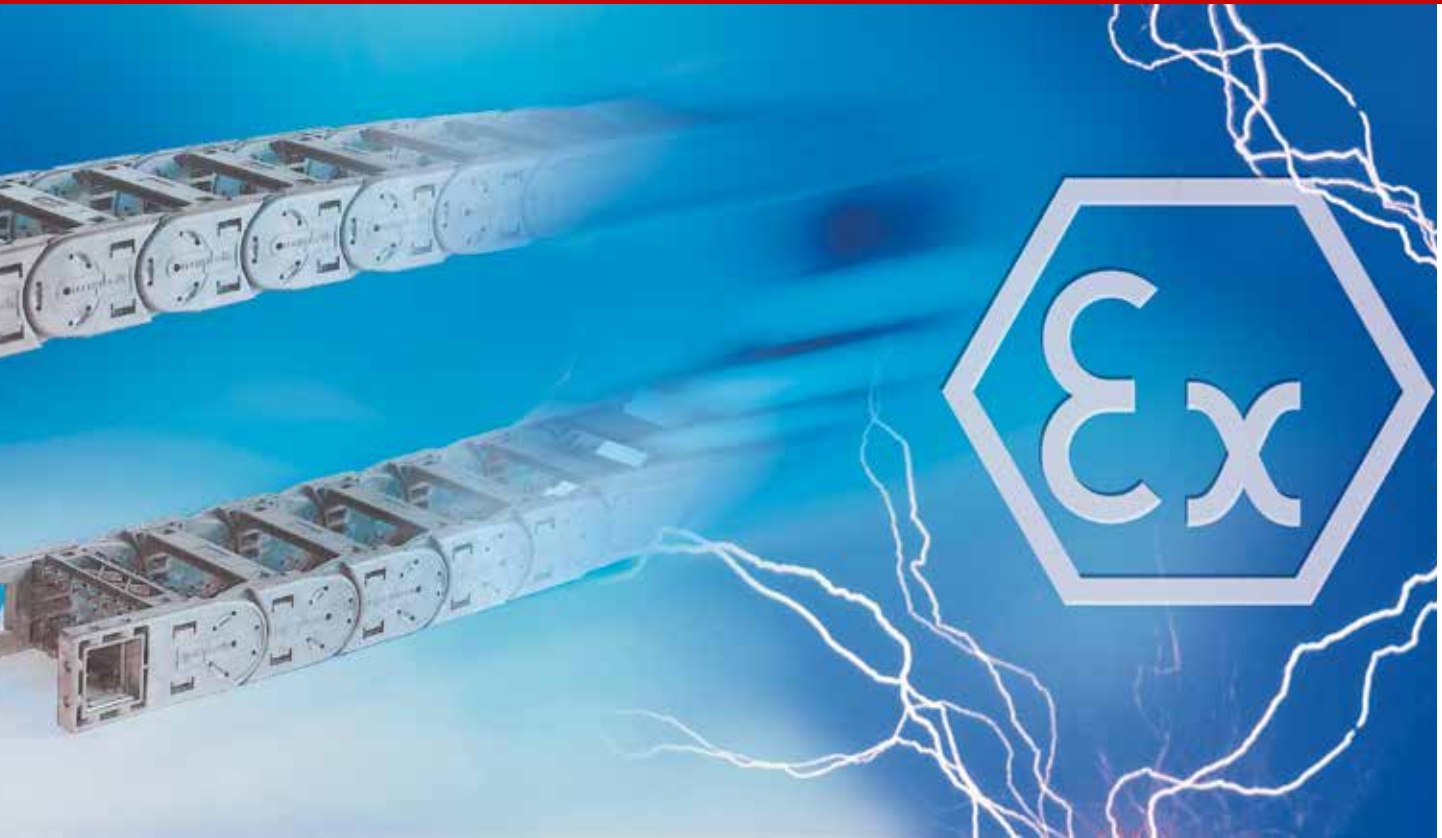

## SAFETY ACCORDING TO ATEX EX II 2GD

Since July 2003, all equipment, components and protective systems used in explosion hazard areas must comply with the ATEX Product Directive 94/P/EC.

Explosions can always occur where flammable gases, vapors, liquids or dusts are produced, stored or transported and, under certain conditions, can form an explosive mixture in conjunction with air. In such explosive atmospheres a small spark is often enough to trigger an explosion.

Our certified cable drag chains made of dissipative ESD material always put you on the safe side!



- Full ATEX EX II 2GD certification
- Simple to exchange, certification remains in force
- For areas at risk of explosion 1, 2, 21, 22



## ELECTROSTATIC DISCHARGES

In many areas of industrial production, the requirements for avoiding electrostatic discharge are growing in order to protect sensitive electronic components.

Friction occurs between machine parts during movement, which can lead to the formation of frictional electricity. Electrostatic discharges that occur after contact with an earthed body can be harmful to sensitive electronic components: They can be destroyed or their function can be affected.

Murrplastik cable drag chains made of ESD material control and permanently dissipate electrostatic charges.



- **Controlled and permanent discharge of electrostatic discharges**
- **Excellent protection of electronic components**
- **Cable drag chains made of ESD material**

# CLEAN ROOM CABLE DRAG CHAINS



## APPLICATION IN SENSITIVE CLEAN ENVIRONMENTS

Clean room cable drag chains from Murrplastik Systemtechnik are produced using special materials. These cable drag chains have excellent clean room properties that meet the highest technical requirements.

Even in continuous operation, our clean room cable drag chains discharge only a minimal amount of particles into the environment.

The clean room certification was carried out and confirmed by the renowned Fraunhofer Institute for Manufacturing Engineering and Automation IPA.

Despite its outstanding abrasion properties, Murrplastik nevertheless refused to compromise in the slightest when it comes to functionality, reliability and ease of assembly.



- Clean room classification by Fraunhofer Institute (IPA)
- Fulfills the ATEX Europe guidelines
- Uncompromising functionality
- Unflinching reliability



## EXTREME AREAS OF APPLICATION REQUIRE DIFFERENT MATERIALS.

The Murrplastik colour coding system enables you to recognise and classify different materials and hence areas of application safely and easily.

Clear assignments, safe use – as with all Murrplastik products.



- Murrplastik colour coding system
- Black cable drag chain:  
Polyamide (PA): standard
- Light gray cable drag chain:  
Polyamide (PA): EMC model
- Oxide red cable drag chain:  
Polyamide (PA), UL 94/V0
- Blue cable drag chain:  
Polypropylene (PP)

# CORPORATE IDENTITY – INDIVIDUAL CABLE DRAG CHAIN IDENTIFICATION



## INDIVIDUAL CABLE DRAG CHAIN IDENTIFICATION

Would you like to individually label your products and stand out from other companies? Should your corporate identity immediately catch the eye?

With our ability to realize locking mechanisms in custom colours and the option to add your company logo, you can set visual signals and accents and give your product a unique identity.

Either access our standard colour palette or ask us for individual solutions.



- Individual product identification
- Locking mechanisms in custom colours
- Addition of company logo on request



# SELECTION CRITERIA FOR CABLE DRAG CHAINS

## IDEALLY, THE DESIGN OF AN CABLE DRAG CHAIN SYSTEM WILL TAKE THE FOLLOWING CRITERIA INTO ACCOUNT:

- Determine the number and outside diameter of the cables or conduits to be laid.
- For self-supporting applications, the diagram “self-supporting length” can be used to identify the matching chain using load and travel distance.
- Determine width of cable drag chain, design shelving system (separators, shelves, etc.).
- Determine the minimum possible bending radius of cabling and conduits, as per manufacturer specifications, and select the matching bending radius for the cable drag chain.
- Determine chain length respective to the travel distance and the selected bending radius. (Using a formula – see matching cable drag chain types)
- Check whether a guide channel is required for the application. For gliding applications, a guide channel is always required.

## SELF-SUPPORTING LENGTHS AND TRAVEL DISTANCES

If the travel distance is too long for self-supporting installation, the chain upper run rests on the chain lower run (the upper run glides over the lower run). We describe this system as a “gliding” type of installation.

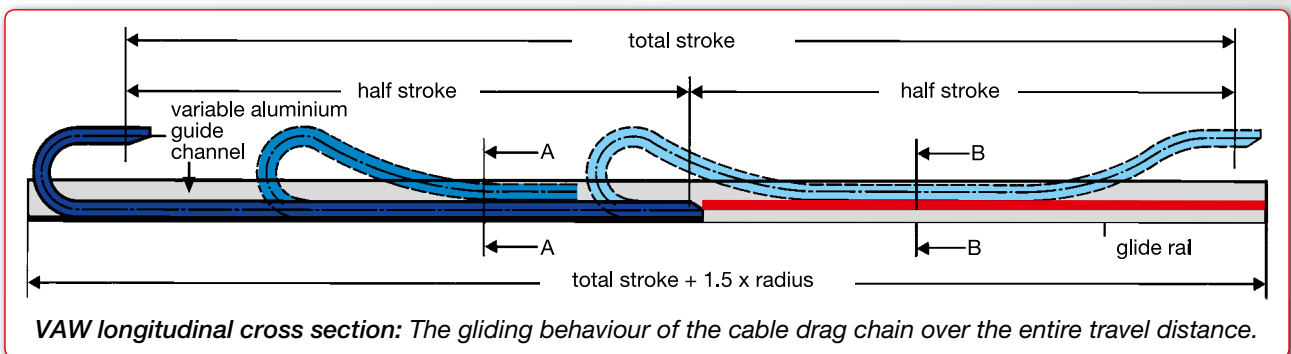
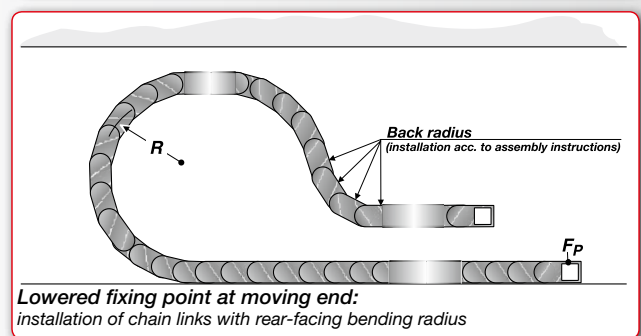
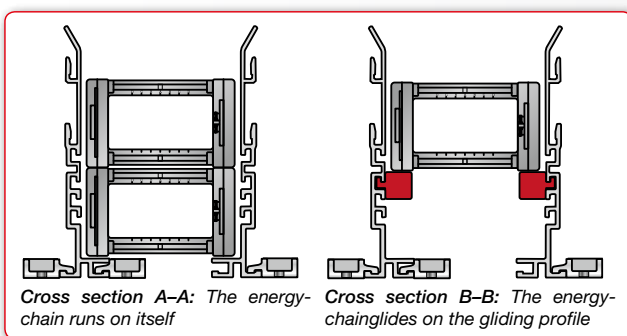

With gliding installations, we recommend setting the chain bracket at the moving end lower, depending on the chain type and bending radius.

Please contact us: we will be very happy to help you design your cable drag chain project. Further information can be found in the “Manual for the design and assembly of cable drag chain systems”, Order No. 8902804550 as well as in our online configuration <https://mymppchain.com/>



		Inside height in mm		Chain type		Crossbars in mm from - to		Covers in mm from - to		INSIDE WIDTH	BENDING RADIUS
		Open	Closed	PA	ALU	PA	ALU	Bending radii in mm, from - to			
<b>MURRPLASTIK SERIES</b>	10	MP 10.1		6 – 41	—	—	—	18 – 58			
	14	MP 14		16 – 40	—	—	—	25 – 75			
	14	MP 15		16 – 40	—	—	—	25 – 75			
	18	MP 18.1/2		15 – 70	—	—	—	28 – 78			
	18	MP 18.4		18 – 50	—	—	—	40 – 80			
	20	MP 20.2		15 – 50	—	—	—	38 – 125			
	25	MP 25.1/2	25.3/25.4	40 – 200	—	40 – 200	—	50 – 300/100 – 300*			
	25		MP 25 G	—	—	26 – 125	—	60 – 250			
	26	MP 3000		26 – 125	—	—	—	50 – 300			
	30	MP 30.1/2	30.3/4	40 – 200	—	40 – 200	—	60 – 300/100 – 300*			
	32/30	MP 32.2	MP 32.3 ALU	45 – 546	67 – 600	45 – 546	43 – 600	80 – 250/120 – 250*			
	35	MP 35.1/2		50 – 175	—	—	—	63 – 250			
	36		MP 36 G	—	—	62 – 125	—	80 – 200			
	38		MP 43 G	—	—	62 – 182	—	125 – 400			
	42/38	MP 41.2	MP 41.3	45 – 546	67 – 600	84 – 246	43 – 600	90 – 350/150 – 350*			
	45	MP 45.1/2		50 – 175	—	—	—	75 – 300			
	52/48	MP 52.2	MP 52.3	45 – 546	67 – 600	96 – 346	43 – 600	100 – 350/150 – 350*			
	52/48	MP 52.2-D	MP 52.3-D	45 – 546	67 – 600	96 – 346	43 – 600	200			
	52/48	MP 52.4	MP 52.5	45 – 546	67 – 600	96 – 346	43 – 600	125 - 300/150 – 300*			
	52/48	MP 52.6	MP 52.7 ALU	—	50 – 600	—	42 – 600	150 – 300			
60		MP 65 G	—	—	84 – 144	—	200 – 400				
62/62	MP 62.2	MP 62.3	93 – 518	72 – 600	118 – 418	40 – 600	150-500/200-500*				
62	MP 62.4	MP 62.5 ALU	45 – 546	67 – 600	—	43 – 600	135 - 300/150 – 300*				
82/74	MP 82.2	MP 82.3	93 – 518	72 – 600	243	40 – 600	150 - 650/200 – 650*				
102	MP 102.2		93 – 518	72 – 600	—	—	250 – 500				
<b>MURRPLASTIK LEGACY PRODUCTS</b> <i>(do not use for new-build projects)</i>	32	MP 32		45 – 546	67 – 600	—	—	80 – 250			
	34	MP 35		62 – 150	—	—	—	70 – 300			
	40	MP 44		45 – 182	—	—	—	90 – 400			
	42	MP 41		45 – 546	67 – 600	—	—	90 – 350			
	52	MP 52.1		45 – 546	67 – 600	80 – 600	—	100 – 350			
	60	MP 66		45 – 182	77 – 600	—	—	150 – 400			
	62	MP 62.1		93 – 518	72 – 600	—	—	150 – 500			
	72	MP 72		93 – 518	72 – 600	118 – 600	—	150 – 500			

\* Note: only for closed variants











		TRAVEL DISTANCE		SPEED		ACCELERATION	
							
		max. travel distance in m self-supporting   gliding applic.		Max. speed of travel in m/s self-supporting   gliding applic.		max. acceleration in m/s <sup>2</sup> self-supporting   gliding applic.	
	1.0	10.0	4.0	2.0	2.0	2.0	62
	2.0	12.0	4.0	2.0	2.0	2.0	68
	2.0	12.0	4.0	2.0	2.0	2.0	74
	3.0	20.0	5.0	2.0	5.0	5.0	80
	3.0	20.0	5.0	2.0	5.0	5.0	86
	3.0	not recommended	10.0	–	10.0	–	92
	4.0	35.0	10.0	3.0	15.0	10.0	162
	4.0	40.0	6.0	3.0	15.0	10.0	106
	4.0	60.0	6.0	3.0	15.0	10.0	98
	4.5	40.0	10.0	3.0	15.0	10.0	174
	4.5	100.0	20.0	5.0	30.0	25.0	186
	6.0	80.0	20.0	5.0	50.0	15.0	114
	4.0	60.0	10.0	3.0	20.0	15.0	126
	5.0	50.0	15.0	5.0	20.0	15.0	134
	7.0	120.0	20.0	5.0	30.0	25.0	202
	7.0	80.0	10.0	5.0	20.0	15.0	142
	9.0	150.0	20.0	5.0	30.0	25.0	218
	9.0	150.0	20.0	5.0	30.0	25.0	234
	7.5	50.0	20.0	5.0	30.0	25.0	250
	–	150.0	–	6.0	–	10.0	266
	8.0	60.0	15.0	5.0	20.0	15.0	154
	10.0	150.0	20.0	5.0	40.0	25.0	290
	7.5	50.0	20.0	5.0	30.0	25.0	276
	10.0	150.0	20.0	5.0	40.0	25.0	304
	10.5	150.0	20.0	5.0	40.0	25.0	318
	5.0	100.0	20.0	5.0	30.0	25.0	330
	4.5	80.0	10.0	3.0	20.0	15.0	344
	5.0	50.0	15.0	5.0	20.0	15.0	366
	7.0	120.0	20.0	5.0	30.0	25.0	352
	9.0	150.0	20.0	5.0	30.0	25.0	374
	8.0	60.0	15.0	5.0	20.0	15.0	400
	10.0	150.0	20.0	5.0	40.0	25.0	388
	10.0	150.0	20.0	5.0	40.0	25.0	408

Catalogue page



## SELECTION TABLE CONFIGURATION

	Inside height in mm	Chain type		CHAIN BRACKET							STRAIN RELIEF	
		Open	Closed	U-part (plastic)	U-part (steel)	Flexible	Angle	Flange	integrated	integrated (RS-ZL)	integrated (bow clamp)	separately mountable (ZL)
<b>MURRPLASTIK SERIES</b>	10	MP 10.1		•					•			
	14	MP 14		•					•			
	14	MP 15		•					•			
	18	MP 18.1/2		•					•			
	18	MP 18.4		•					•			
	20	MP 20.2		•					•			
	25	MP 25.1/2	25.3/25.4			•				•	•	
	25		MP 25 G		•							•
	26	MP 3000		•			•		•			•
	30	MP 30.1/2	30.3/4			•				•	•	
	32/30	MP 32.2	MP 32.3 ALU			•				•	•	
	35	MP 35.1/2				•				•	•	
	36		MP 36 G		•			•				•
	38		MP 43 G				•					•
	42/38	MP 41.2	MP 41.3			•	•			•	•	
	45	MP 45.1/2				•				•	•	
	52/48	MP 52.2	MP 52.3			•	•			•	•	
	52/48	MP 52.2-D	MP 52.3-D			•	•			•	•	
	52/48	MP 52.4	MP 52.5			•				•	•	
	52/48	MP 52.6	MP 52.7 ALU			•					•	
60		MP 65 G		•		•	•					
62/62	MP 62.2	MP 62.3			•	•			•	•		
62	MP 62.4	MP 62.5 ALU			•				•	•		
82/74	MP 82.2	MP 82.3			•				•	•		
102	MP 102.2					•			•	•		
<b>MURRPLASTIK LEGACY PRODUCTS</b> <i>(do not use for new-build projects)</i>	32	MP 32			•					•	•	
	34	MP 35			•		•					•
	40	MP 44			•		•					•
	42	MP 41				•	•			•	•	
	52	MP 52.1				•	•			•	•	
	60	MP 66			•		•	•				
	62	MP 62.1				•	•			•	•	
	72	MP 72				•	•			•	•	

				ACCESSORIES			SHELVING SYSTEM								
				Sliding blocks (GS)	Damping elements for the side links	Gliding plates (GLP)	Bracket bars (BS)	Separator with snap-lock (TR/TRT)	Separator (TR-V)	Separator fixed	Shelving system (RTT)	Shelving system	Crossbar connector (RSY)	H-shaped shelf unit (RE)	Catalogue page
															
															62
															68
															74
															80
															86
															92
															162
															106
															98
															174
															186
															114
															126
															134
															202
															142
															218
															234
															250
															266
															154
															290
															276
															304
															318
															330
															344
															366
															352
															374
															400
															388
															408

	Inside height in mm	Chain type	OPENING VARIANTS									Catalogue page		
			No opening	Slitted	Inside bend foldable on one side*	Outside bend foldable on one side*	Inside bend foldable on both sides*	Outside bend foldable on both sides*	Inside and outside bend engage seamlessly	Inside and outside bend engage				
	Open	Closed	1	2	3	4	5	6	7	8	9			
<b>MURRPLASTIK SERIES</b>	10	MP 10.1		•								62		
	14	MP 14				•						68		
	14	MP 15		•								74		
	18	MP 18.1/2			•	•						80		
	18	MP 18.4		•								86		
	20	MP 20.2			•							92		
	25	MP 25.1/2	25.3/25.4					•	•				162	
	25		MP 25 G				•						106	
	26	MP 3000						•					98	
	30	MP 30.1/2	30.3/4					•	•				174	
	32/30	MP 32.2	MP 32.3 ALU									•	186	
	35	MP 35.1/2						•	•				114	
	36		MP 36 G			•							126	
	38		MP 43 G								•		134	
	42/38	MP 41.2	MP 41.3									•	202	
	45	MP 45.1/2						•	•				142	
	52/48	MP 52.2	MP 52.3									•	218	
	52/48	MP 52.2-D	MP 52.3-D									•	234	
	52/48	MP 52.4	MP 52.5									•	250	
	52/48	MP 52.6	MP 52.7 ALU									•	266	
60		MP 65 G								•		154		
62/62	MP 62.2	MP 62.3									•	290		
62	MP 62.4	MP 62.5 ALU									•	276		
82/74	MP 82.2	MP 82.3									•	304		
102	MP 102.2										•	318		
<b>MURRPLASTIK LEGACY PRODUCTS</b> <i>(do not use for new-build projects)</i>	32	MP 32								•		330		
	34	MP 35							•			344		
	40	MP 44								•		366		
	42	MP 41								•		352		
	52	MP 52.1								•		374		
	60	MP 66								•		400		
	62	MP 62.1								•		388		
	72	MP 72								•		408		

\* Note: not recommended for gliding applications

SELECTION TABLE AVAILABLE MATERIAL / RECOMMENDED GUIDE CHANNELS



	Inside height in mm	Chain type		MATERIAL				GUIDE CHANNEL								
		Open	Closed	Standard	ESD/ATEX/Clean room	PA black	PA gray	Fireprotected UL94V0	H2O environment	PA red	PP blue	rcmd - aluminium guide channel (for self-supporting application)	rcmd - aluminium guide channel (for gliding application)	rcmd - stainless steel* guide channel (for self-supporting application)	rcmd - stainless steel* guide channel (for gliding application)	Catalogue page
								VAW	VAW	VAW-E	VAW-E					
<b>MURRPLASTIK SERIES</b>	10	MP 10.1		•	•	•		25	80	—	—	62				
	14	MP 14		•				25	80	—	—	68				
	14	MP 15		•	•	•		25	80	—	—	74				
	18	MP 18.1/2		•	•	•	•	35	80	—	—	80				
	18	MP 18.4		•				35	80	—	—	86				
	20	MP 20.2		•				35	80	—	—	92				
	25	MP 25.1/2	25.3/25.4	•				80	86	120	120	162				
	25		MP 25 G	•	•			80	86	120	120	106				
	26	MP 3000		•	•	•	•	80	86	120	120	98				
	30	MP 30.1/2	30.3/4	•				80	86	120	120	174				
	32/30	MP 32.2	MP 32.3 ALU	•	•		•	86	106	120	120	186				
	35	MP 35.1/2		•				80	86	120	120	114				
	36		MP 36 G	•				80	86	120	120	126				
	38		MP 43 G	•				86	106	120	120	134				
	42/38	MP 41.2	MP 41.3	•	•		•	86	122	120	120	202				
	45	MP 45.1/2		•				86	106	120	120	142				
	52/48	MP 52.2	MP 52.3	•	•		•	86	146	120	170	218				
	52/48	MP 52.2-D	MP 52.3-D	•	•		•	86	146	120	170	234				
	52/48	MP 52.4	MP 52.5	•				86	146	120	170	250				
	52/48	MP 52.6	MP 52.7 ALU	•				—	146	—	170	266				
60		MP 65 G	•				86	146	120	170	154					
62/62	MP 62.2	MP 62.3	•	•		•	106	177	120	170	290					
62	MP 62.4	MP 62.5 ALU	•				106	146	120	170	276					
82/74	MP 82.2	MP 82.3	•	•		•	146	248	170	220	304					
102	MP 102.2		•				146	248	170		318					
<b>MURRPLASTIK LEGACY PRODUCTS</b> <i>(do not use for new-build projects)</i>	32	MP 32		•				86	106	120	120	330				
	34	MP 35		•				80	86	120	120	344				
	40	MP 44		•				86	106	120	120	366				
	42	MP 41		•				86	106	120	120	352				
	52	MP 52.1		•				86	146	120	170	374				
	60	MP 66		•				86	146	120	170	400				
	62	MP 62.1		•				106	177	120	170	388				
	72	MP 72		•				122	177	120	170	408				

\* Note: also available in steel

## Installation options for cable drag chains

	<p><b>1</b> Horizontal installation option, self-supporting</p>		<p><b>7</b> Horizontal installation option, parallel</p>
	<p><b>2</b> Horizontal installation option, gliding</p>		<p><b>8</b> Horizontal installation option, opposed</p>
	<p><b>3</b> Horizontal installation option, self-supporting, overlap with support</p>		<p><b>9</b> Vertical installation option, standing</p>
	<p><b>4</b> Horizontal installation option, circular movement Design using reverse bending radius</p>		<p><b>10</b> Vertical installation option, hanging</p>
	<p><b>5</b> Horizontal installation option, side-mounted (rotated 90°)</p>		<p><b>11</b> Horizontal/vertical combined installation option</p>
	<p><b>6</b> Horizontal installation option, side-mounted (rotated 90°) with support</p>		<p><b>12</b> Horizontal installation option, interlocked</p>



Quotation  Order Date:

<b>Project designation:</b>		<b>Project implementation in week/year:</b>
<b>Customer No.:</b>	<b>Customer information:</b>	<b>Planning extent:</b>
Company:		<input type="checkbox"/> Cable drag chain (CDC)
Department:		<input type="checkbox"/> Guide channel
Contact person:		<input type="checkbox"/> Tubes
Address/PO Box:		<input type="checkbox"/> Cables
Address/PO Box:		<input type="checkbox"/> Wire connection
Phone and extension no.:		<input type="checkbox"/> Complete assembly
Fax and extension no.:		<input type="checkbox"/> MP on-site assembly service
E-mail address:		

**Application parameters:**

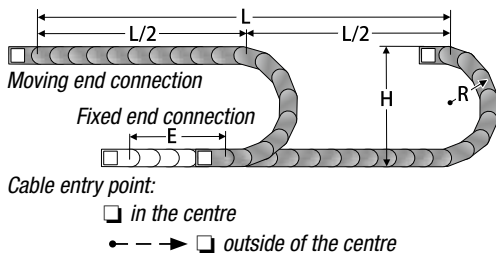

**Please select type of installation:**

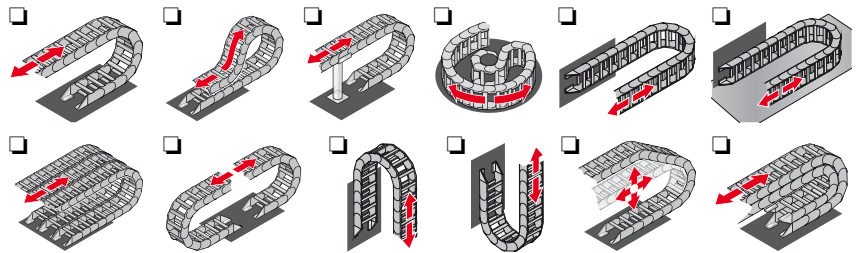

CDC type (also competitors):		Quantity of CDC:	Units
CDC length (if predefined):	mm	Quantity of links:	Units
Travel distance (L):	mm	Minimum bending radius (R):	mm
Maximum installation height (H):	mm	Maximum installation width:	mm
Speed of travel:	m/s	Material:	<input type="checkbox"/> PA (Standard)
Acceleration:	m/s <sup>2</sup>		<input type="checkbox"/> PA UL V0
Travel frequency:	cycles/day		<input type="checkbox"/> PA ESD
Load:	kg/m		<input type="checkbox"/> PP
Ambient temperature (from - to):	°C °C		
Environmental influences:	<input type="checkbox"/> Outdoor application <input type="checkbox"/> Dirt <input type="checkbox"/> Swarf <input type="checkbox"/> Dust <input type="checkbox"/>		
Feed-in (cable entry point):	<input type="checkbox"/> Centre of travel distance <input type="checkbox"/> Ends of travel distance		
Dist. E between entry point and middle of travel dist.:	mm from the centre of the travel distance		

1. Inside/Down   2. Inside/Up   3. Outside/down   4. Outside/up   5. Front/Inside   6. Front/outside   7. Flex/bush   8. Flex/thread  
 9. U-part/below   10. U-part/above   11. Up 90°   12. Down 90°

**Chain bracket**

Fixed end connection - no.:   
 Moving end connection - no.:

Case example: KA/F with C-profile and Steel Fix bow clamps 	<b>Strain relief</b>	Case example: KA/F with crossbar strain relief plate RS-ZL 
	<input type="checkbox"/> Crossbar strain relief plate (type RS-ZL with standard inside widths up to 246 mm)	
	<input type="checkbox"/> Strain relief plates (type ZL for strain relief outside of the chain bracket)	
	<input type="checkbox"/> C-profile including strain relief plate (type ZL-C Set)	
	<input type="checkbox"/> C-profile	
<input type="checkbox"/> Steel Fix bow clamps	Type:	
<input type="checkbox"/> on both sides		

Cut out and fax/copy

<b>Project designation:</b>	<b>Project implementation in week/year:</b>
-----------------------------	---

<b>Opening variant cable drag chain (loading side)</b>	<input type="checkbox"/> inside bend	<input type="checkbox"/> outside bend
	<input type="checkbox"/> on both sides	

<b>Variable guide channel system</b>		
<input type="checkbox"/> Murrplastik quotation requested		Material: <input type="checkbox"/> Plastic <input type="checkbox"/> Aluminium <input type="checkbox"/> Stainless steel <input type="checkbox"/> Steel (zinc-plated)
<input type="checkbox"/> Guide channel existing / dimensions		Additional foreign components:
Internal width of the guide channel:	mm	
Internal height of the guide channel:	mm	
Distance of bearing profiles:	mm	

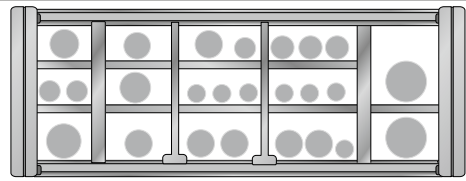
<b>Partitioning the energy carriers (cables, tubes) into the internal chain compartment</b>	
<input type="checkbox"/> Chain compartment is supposed to be designed by Murrplastik <input type="checkbox"/> Assignment according to Murrplastik cable request form <input type="checkbox"/> Murrplastik is supposed to be supply cables, details in MP cable request form <input type="checkbox"/> Chain compartment according to customer request (see sketch below) <input type="checkbox"/> Cables provided by customer (remark outside diameters below)	 <p><i>Example: Multi-layer internal chain compartment</i></p>

**Sketches, notes, specific features:**





<b>Project designation:</b>		
<b>Position within CDC cable request form no.:</b>		<b>Features:</b>
Cable reference type:		<input type="checkbox"/> No shielding
Conduit construction/design:		<input type="checkbox"/> shielded (see below: <i>Shield processing</i> )
Contact person:		<input type="checkbox"/> Cable without protective conductor PE
<p><b>Cables with green-yellow protective conductor (PE) are standard (exception: bus and data cables up to 0.75mm<sup>2</sup>).</b> Cables with PE are often also marked with G, e.g. 3G1.5 means two normal conductors and 1 PE with a cross section of 1.5mm<sup>2</sup> each.</p>		

### Customisation of cable endings

<b>FP aspect (fixed point connection)</b>	<b>MP aspect (moving point connection)</b>
<input type="checkbox"/> Ending not processed – cable cut to total length only	<input type="checkbox"/> Ending not processed – cable cut to total length only

**alternatively:**

**alternatively:**

<input type="checkbox"/> Ending with connector		<input type="checkbox"/> Ending with connector	
Item No. of connector		Item No. of connector	
Description, supplier:		Description, supplier:	
<b>Connections (quantity of contacts):</b>		<b>Connections (quantity of contacts):</b>	
<input type="checkbox"/> Male connector		<input type="checkbox"/> Male connector	
<input type="checkbox"/> Female connector		<input type="checkbox"/> Female connector	
Item No. of contact:		Item No. of contact:	
<b>Housing for connector:</b>		<b>Housing for connector:</b>	
Item No. / design:		Item No. / design:	
Cable outlet on housing:	<input type="checkbox"/> straight <input type="checkbox"/> sideways	Cable outlet on housing:	<input type="checkbox"/> straight <input type="checkbox"/> sideways
<b>Cable compression gland (type):</b>		<b>Cable compression gland (type):</b>	

#### Wiring specifications

- Pin assignment: see enclosed plan or chart
  - Standard wiring as extension cord (pin 1 to 1, 2 to 2 etc.)
- When used as an extension the connectors are wired from pin 1. If there are not enough wires, the high contact pins will be unconnected.

**alternatively:**

**alternatively:**

<input type="checkbox"/> End processed (without housing)		<input type="checkbox"/> End processed (without housing)	
bared cable length (jacket free):		bared cable length (jacket free):	
Wire end ferrule:		Wire end ferrule:	
Contacts:		Contacts:	
Ring-type cable lugs:		Ring-type cable lugs:	
	(Type, supplier, item No., size, which wire?)		(Type, supplier, item No., size, which wire?)

<input type="checkbox"/> Shield processing	Entire shield	if nec. pair(s) of wire(s)	<input type="checkbox"/> Shield processing	Entire shield	if nec. pair(s) of wire(s)
cut:			cut:		
on housing:			on housing:		
shield connected to pin No.:			shield connected to pin No.:		
extended with wire/length:		mm	extended with wire/length:		mm
shield bent back on jacket:			shield bent back on jacket:		

<input type="checkbox"/> Labelling	Short text:	<input type="checkbox"/> Labelling	Short text:
<input type="checkbox"/> label cable jacket (sticker, ESL):		<input type="checkbox"/> label cable jacket (sticker, ESL):	
<input type="checkbox"/> label single wire(s) (e.g. KDE):		<input type="checkbox"/> label single wire(s) (e.g. KDE):	
Distance from jacket/cable end:	mm	Distance from jacket/cable end:	mm

Additional text for labelling: see attached circuit diagram:

Notes (attachments etc.):

## Murrplastik Glossary – So that you know what we are talking about

We want to make our products and product components as accessible to you as possible. So what, then, are the actual names Murrplastik uses for specific components?

You'll find the answers in this Glossary. We have prepared some schematic drawings of sub-assemblies and individual components for you with the terms that we use for them.

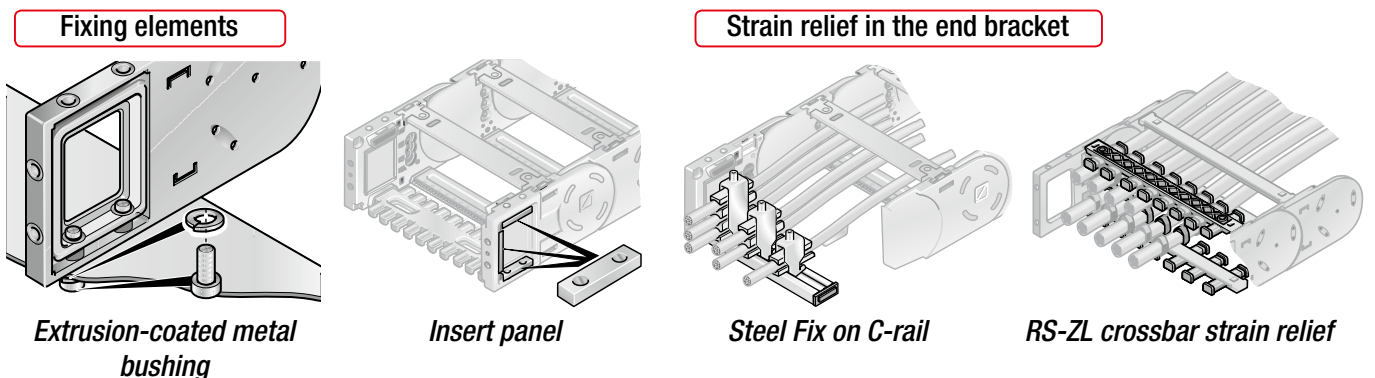
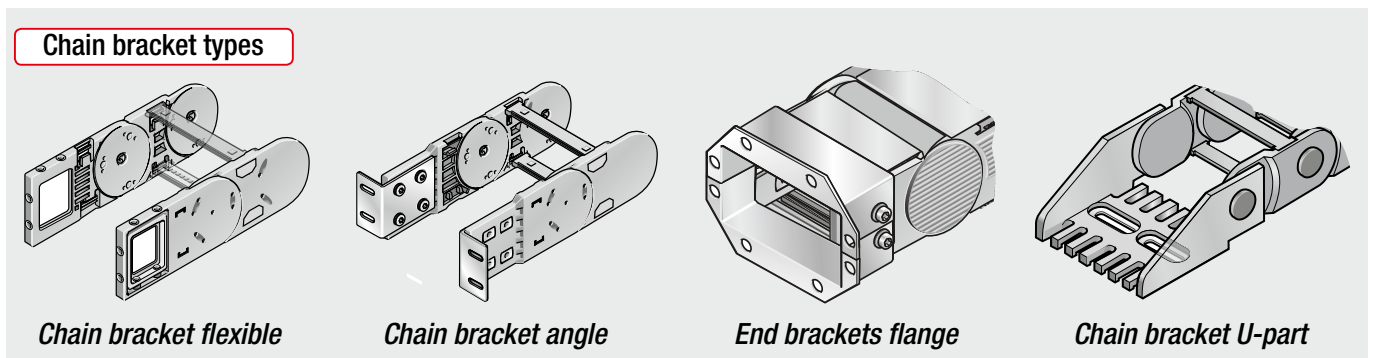
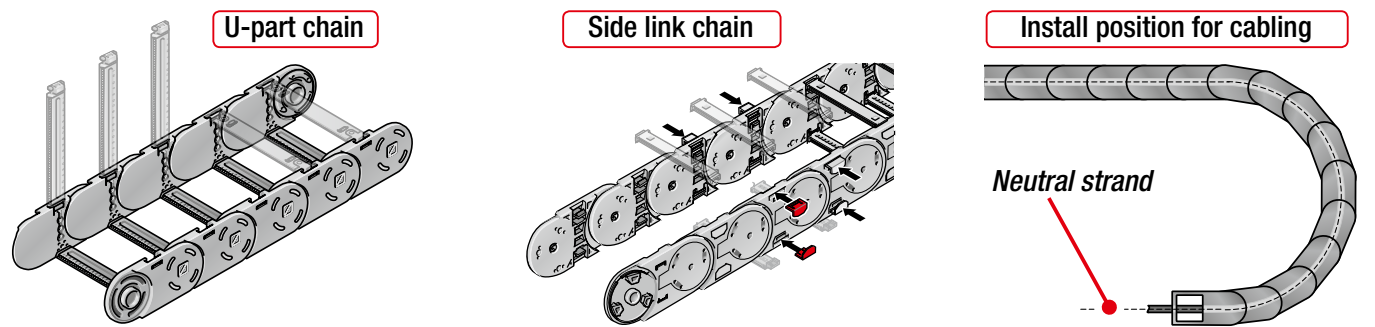
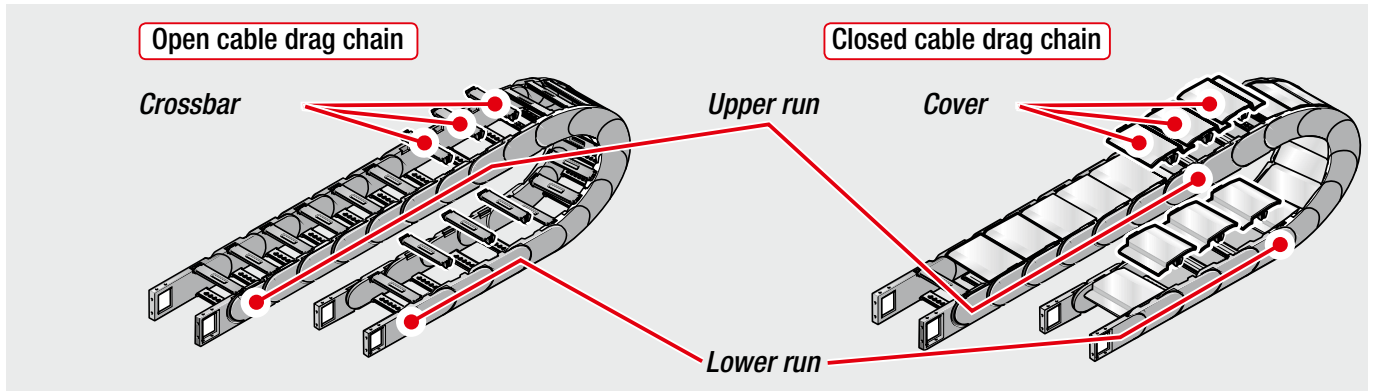

# Murrplastik Glossary – So that you know what we are talking about

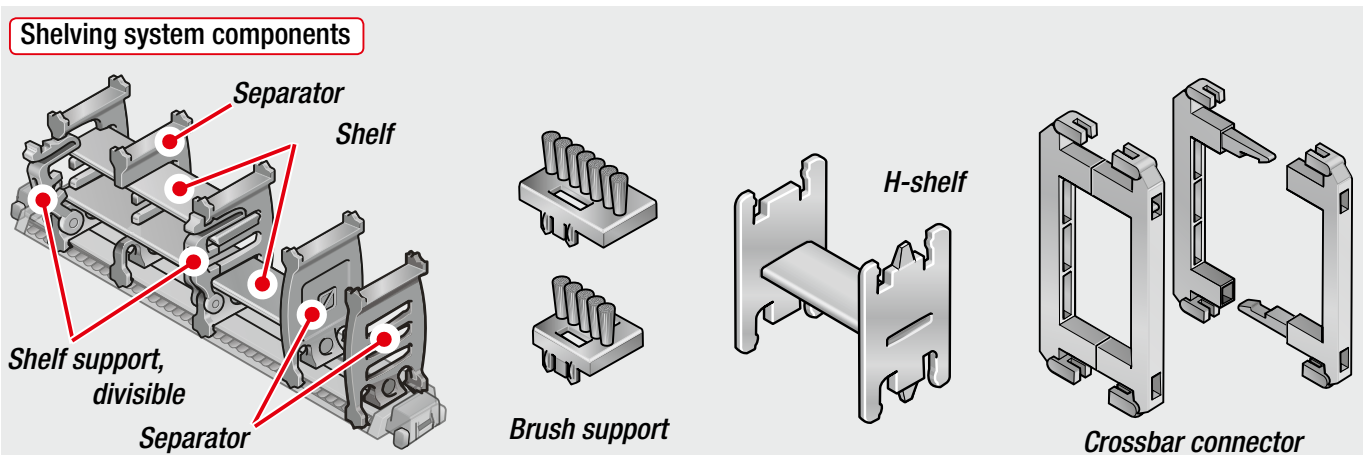
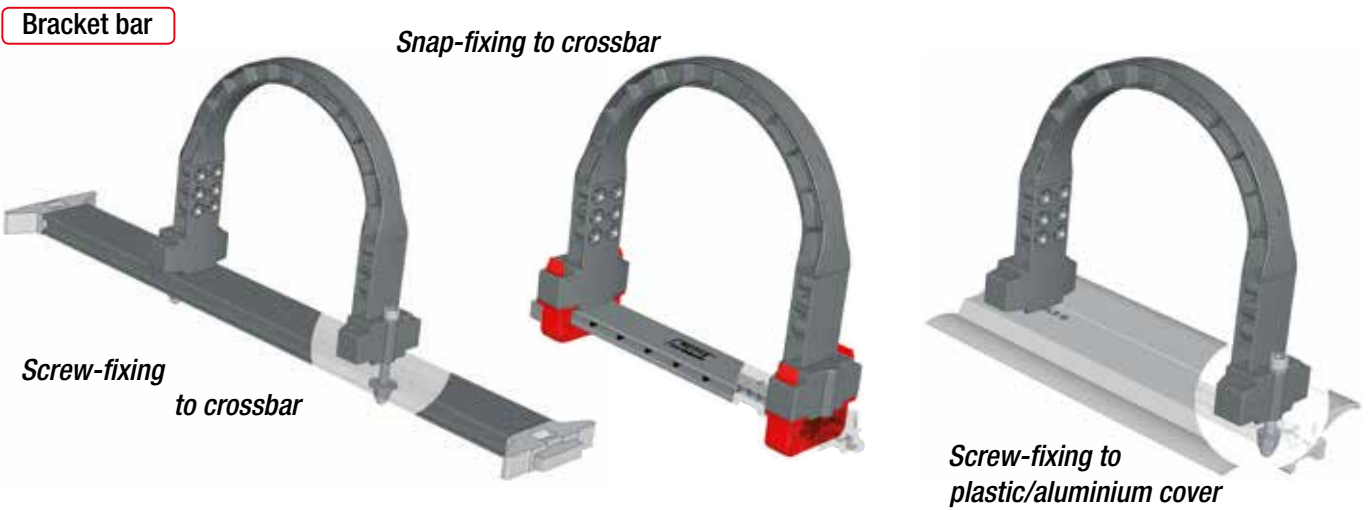
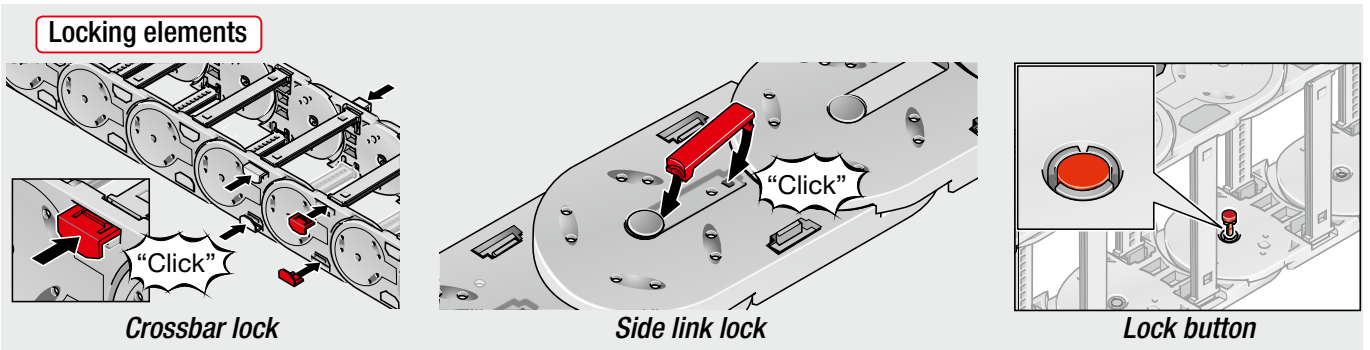
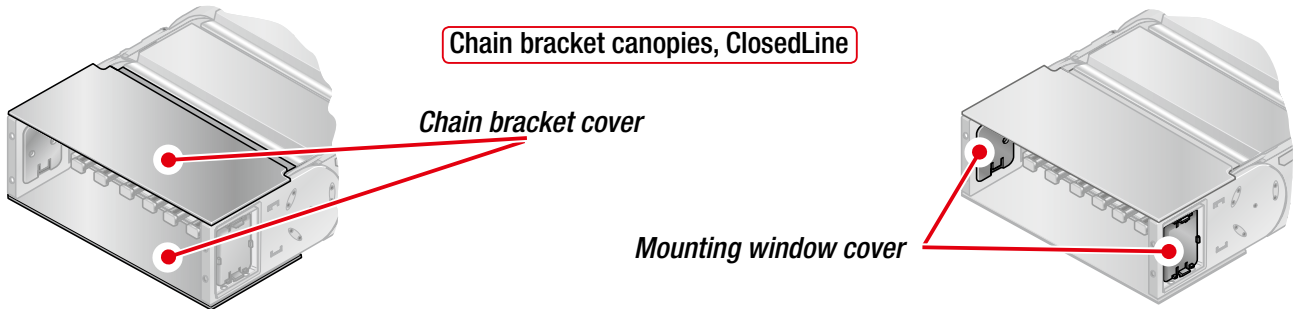

## Murrplastik Glossary – So that you know what we are talking about

Our guide channel systems and their accessory parts are also given specific names. So what, then, are the names Murrplastik uses for specific components?

You'll find the answers in this Glossary. We have prepared some schematic drawings of sub-assemblies and individual components for you with the terms that we use for them.

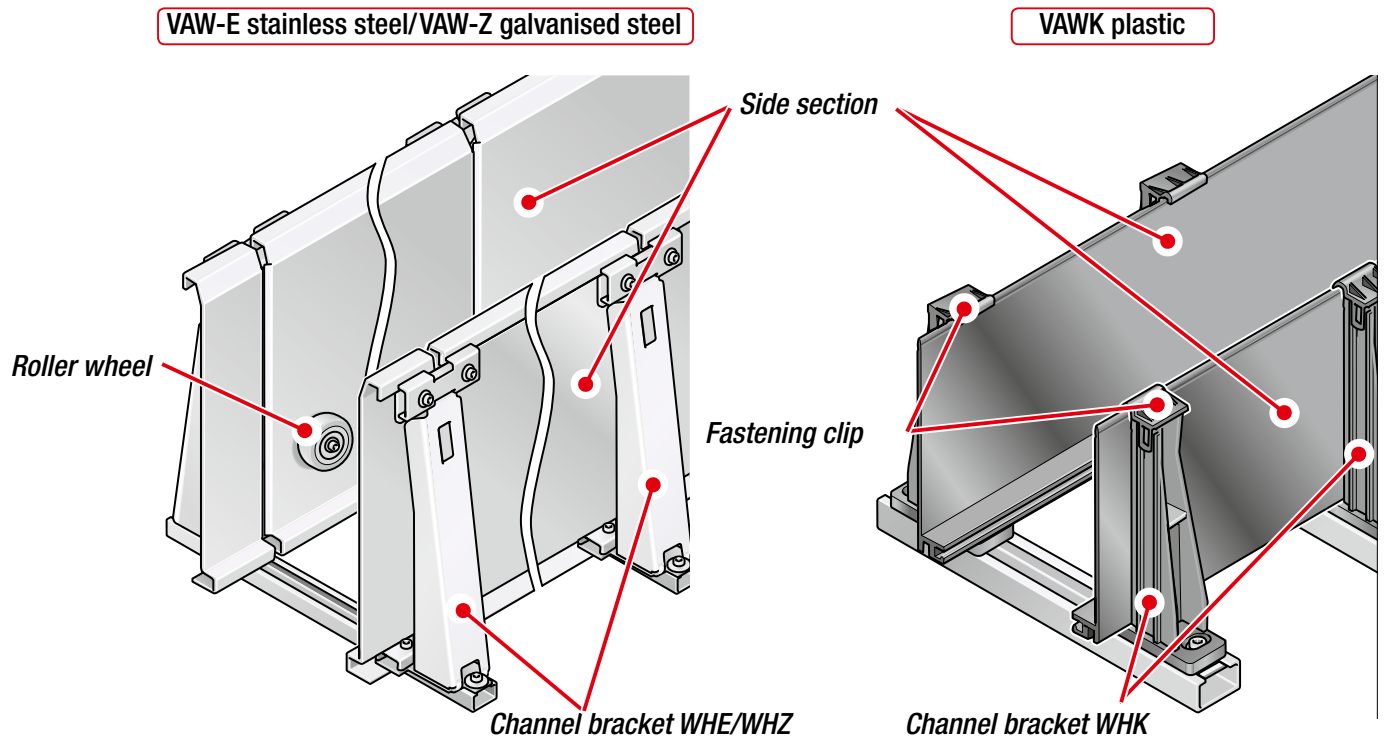
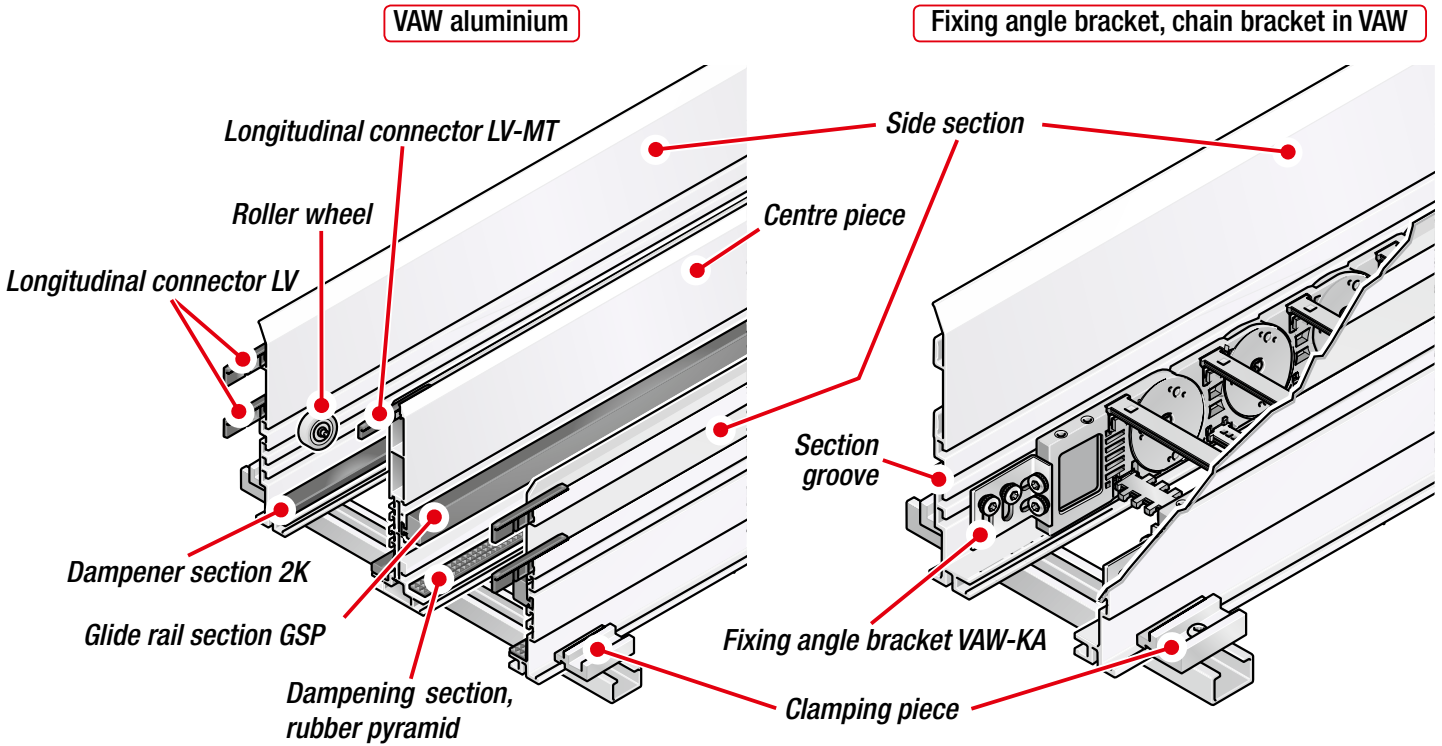

**EasyLine  
MP 10.1**

**open**  
Page 62

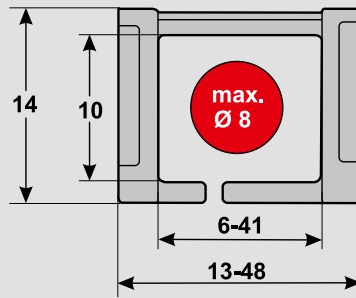

- Internal height: 10.0 mm
- Internal widths: 6.0 – 41.0 mm
- Radii: 18.0 – 58.0 mm
- Pitch: 15.0 mm
- Links per metre: 67 qty.
- Loading side: Outside bend slitted

**MultiLine  
MP 14**

**open**  
Page 68

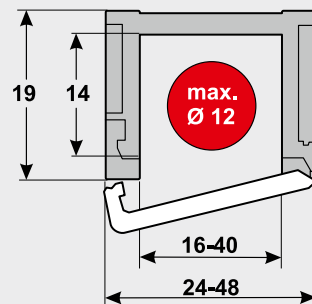

- Internal height: 14.0 mm
- Internal widths: 16.0 – 40.0 mm
- Radii: 25.0 – 75.0 mm
- Pitch: 26.0 mm
- Links per metre: 39 qty.
- Loading side: Outside bend

**MultiLine  
MP 15**

**open**  
Page 74

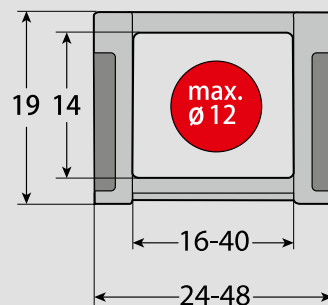

- Internal height: 14.0 mm
- Internal widths: 16.0 – 40.0 mm
- Radii: 25.0 – 75.0 mm
- Pitch: 26.0 mm
- Links per metre: 39 qty.
- Loading side: Non-opening

**MultiLine  
MP 18.1  
MP 18.2**

**open  
open**  
Page 80

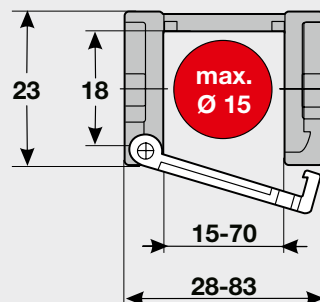

- Internal height: 18.0 mm
- Internal widths: 15.0 – 70.0 mm
- Radii: 28.0 – 78.0 mm
- Pitch: 33.0 mm
- Links per metre: 30 qty.
- Loading side: Inside or outside bend



- Travel distance gliding  $L_g$  max.: 10.0 m
- Travel distance self-supporting  $L_f$  max.: see diagram on page 65
- Travel distance vertical, hanging  $L_{vh}$  max.: 2.0 m
- Travel distance vertical, upright  $L_{vs}$  max.: 1.0 m
- Rotated 90°, unsupported  $L_{90f}$  max.: not recommended
- Speed, gliding  $V_g$  max.: 2.0 m/s
- Speed, self-supporting  $V_f$  max.: 4.0 m/s
- Acceleration, gliding  $a_g$  max.: 2.0 m/s<sup>2</sup>
- Acceleration, self-supporting  $a_f$  max.: 2.0 m/s<sup>2</sup>

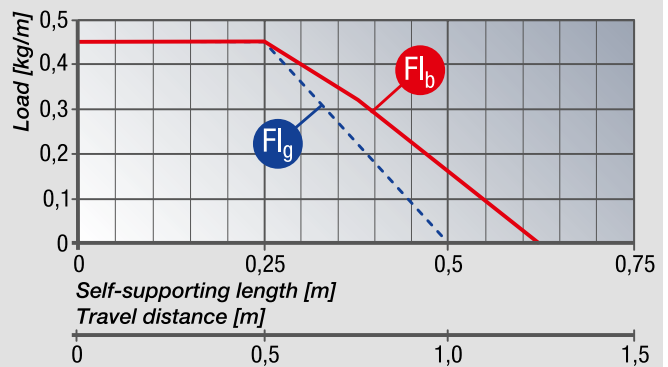

- Travel distance gliding  $L_g$  max.: 12.0 m
- Travel distance self-supporting  $L_f$  max.: see diagram on page 71
- Travel distance vertical, hanging  $L_{vh}$  max.: 3.0 m
- Travel distance vertical, upright  $L_{vs}$  max.: 2.0 m
- Rotated 90°, unsupported  $L_{90f}$  max.: not recommended
- Speed, gliding  $V_g$  max.: 2.0 m/s
- Speed, self-supporting  $V_f$  max.: 4.0 m/s
- Acceleration, gliding  $a_g$  max.: 2.0 m/s<sup>2</sup>
- Acceleration, self-supporting  $a_f$  max.: 2.0 m/s<sup>2</sup>

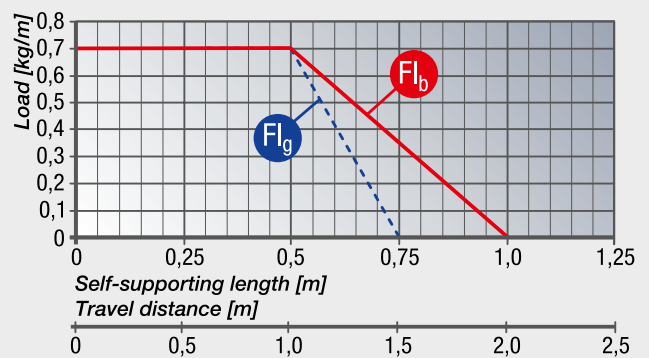

- Travel distance gliding  $L_g$  max.: 12.0 m
- Travel distance self-supporting  $L_f$  max.: see diagram on page 77
- Travel distance vertical, hanging  $L_{vh}$  max.: 3.0 m
- Travel distance vertical, upright  $L_{vs}$  max.: 2.0 m
- Rotated 90°, unsupported  $L_{90f}$  max.: not recommended
- Speed, gliding  $V_g$  max.: 2.0 m/s
- Speed, self-supporting  $V_f$  max.: 4.0 m/s
- Acceleration, gliding  $a_g$  max.: 2.0 m/s<sup>2</sup>
- Acceleration, self-supporting  $a_f$  max.: 2.0 m/s<sup>2</sup>

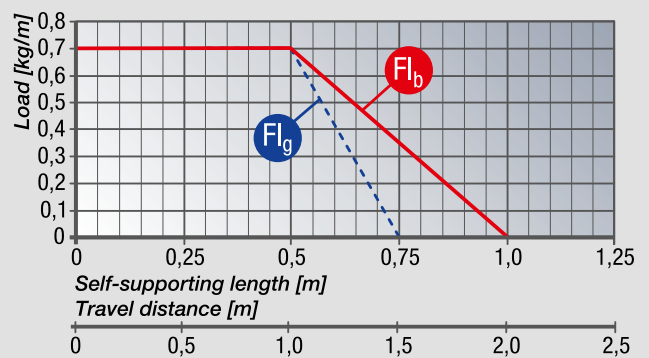

- Travel distance gliding  $L_g$  max.: 20.0 m
- Travel distance self-supporting  $L_f$  max.: see diagram on page 83
- Travel distance vertical, hanging  $L_{vh}$  max.: 8.0 m
- Travel distance vertical, upright  $L_{vs}$  max.: 3.0 m
- Rotated 90°, unsupported  $L_{90f}$  max.: 0.5 m
- Speed, gliding  $V_g$  max.: 2.0 m/s
- Speed, self-supporting  $V_f$  max.: 5.0 m/s
- Acceleration, gliding  $a_g$  max.: 5.0 m/s<sup>2</sup>
- Acceleration, self-supporting  $a_f$  max.: 5.0 m/s<sup>2</sup>

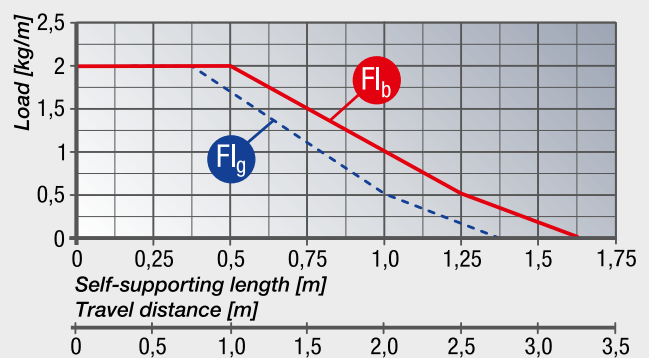

**MultiLine  
MP 18.4**

**open**  
Page 86

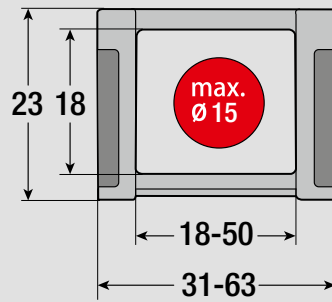

- Internal height: 18.0 mm
- Internal widths: 18.0 – 50.0 mm
- Radii: 40.0 – 80.0 mm
- Pitch: 33.0 mm
- Links per metre: 33 qty.
- Loading side: Non-opening

**MultiLine  
MP 20**

**open**  
Page 92

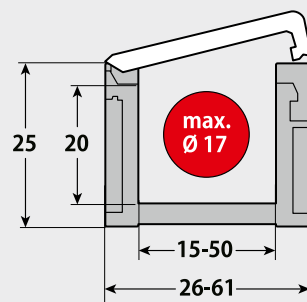

- Internal height: 20.0 mm
- Internal widths: 15.0 – 50.0 mm
- Radii: 38.0 – 125.0 mm
- Pitch: 35.0 mm
- Links per metre: 29 qty.
- Loading side: Inside bend

**MultiLine  
MP 25G**

**closed**  
Page 106

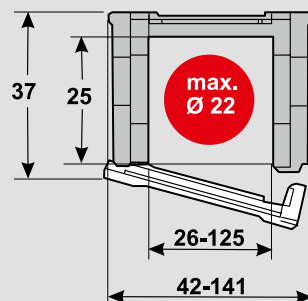

- Internal height: 25.0 mm
- Internal widths: 26.0 – 125.0 mm
- Radii: 60.0 – 250.0 mm
- Pitch: 30.0 mm
- Links per metre: 33 qty.
- Loading side: Outside bend

**ModulLine  
MP 25.1/.2  
MP 25.3/.4**

**open  
closed**  
Page 162

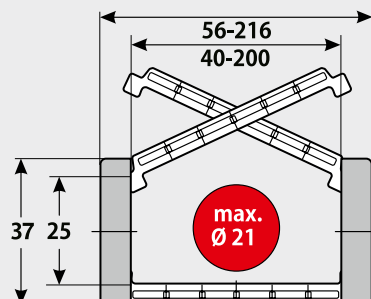

- Internal height: 25.0 mm
- Internal widths: 40.0 – 200.0 mm
- Radii: 50.0 – 300.0 mm
- Pitch: 45.0 mm
- Links per metre: 22 qty.
- Loading side: Inside or outside bend

- Travel distance gliding  $L_g$  max.: 20.0 m
- Travel distance self-supporting  $L_f$  max.: see diagram on page 89
- Travel distance vertical, hanging  $L_{vh}$  max.: 8.0 m
- Travel distance vertical, upright  $L_{vs}$  max.: 3.0 m
- Rotated 90°, unsupported  $L_{90f}$  max.: 0.5 m
- Speed, gliding  $V_g$  max.: 2.0 m/s
- Speed, self-supporting  $V_f$  max.: 5.0 m/s
- Acceleration, gliding  $a_g$  max.: 5.0 m/s<sup>2</sup>
- Acceleration, self-supporting  $a_f$  max.: 5.0 m/s<sup>2</sup>

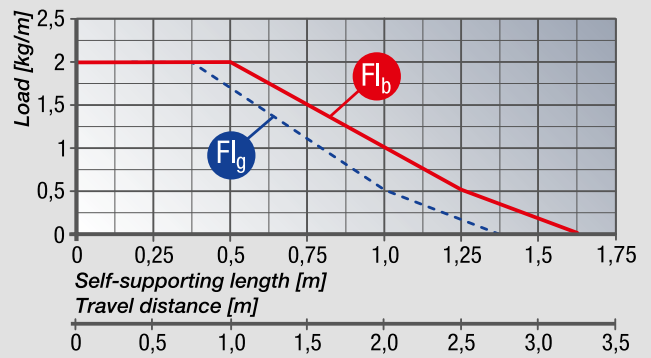

- Travel distance gliding  $L_g$  max.: not recommended
- Travel distance self-supporting  $L_f$  max.: see diagram on page 95
- Travel distance vertical, hanging  $L_{vh}$  max.: 8.0 m
- Travel distance vertical, upright  $L_{vs}$  max.: 3.0 m
- Rotated 90°, unsupported  $L_{90f}$  max.: 0.5 m
- Speed, self-supporting  $V_f$  max.: 10.0 m/s
- Acceleration, self-supporting  $a_f$  max.: 10.0 m/s<sup>2</sup>

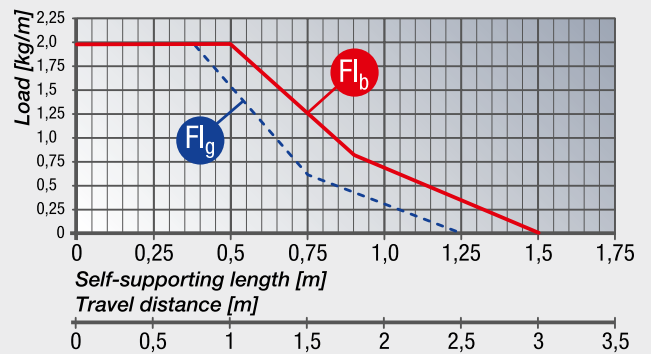

- Travel distance gliding  $L_g$  max.: 40.0 m
- Travel distance self-supporting  $L_f$  max.: see diagram on page 109
- Travel distance vertical, hanging  $L_{vh}$  max.: 25.0 m
- Travel distance vertical, upright  $L_{vs}$  max.: 3.0 m
- Rotated 90°, unsupported  $L_{90f}$  max.: 1.0 m
- Speed, gliding  $V_g$  max.: 3.0 m/s
- Speed, self-supporting  $V_f$  max.: 6.0 m/s
- Acceleration, gliding  $a_g$  max.: 10.0 m/s<sup>2</sup>
- Acceleration, self-supporting  $a_f$  max.: 15.0 m/s<sup>2</sup>

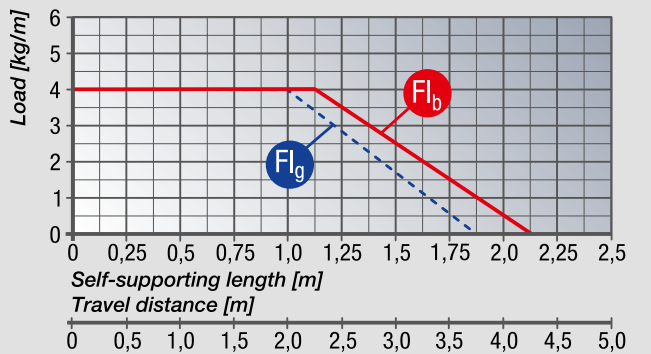

- Travel distance gliding  $L_g$  max.: 35.0 m
- Travel distance self-supporting  $L_f$  max.: see diagram on page 165
- Travel distance vertical, hanging  $L_{vh}$  max.: 25.0 m
- Travel distance vertical, upright  $L_{vs}$  max.: 3.0 m
- Rotated 90°, unsupported  $L_{90f}$  max.: 0.7 m
- Speed, gliding  $V_g$  max.: 3.0 m/s
- Speed, self-supporting  $V_f$  max.: 10.0 m/s
- Acceleration, gliding  $a_g$  max.: 10.0 m/s<sup>2</sup>
- Acceleration, self-supporting  $a_f$  max.: 15.0 m/s<sup>2</sup>

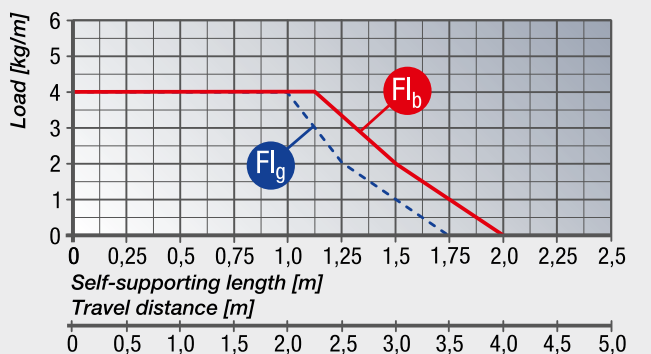

**MultiLine  
MP 3000**

**open**  
Page 98

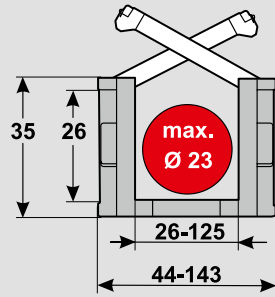

- Internal height: 26.0 mm
- Internal widths: 26.0 – 125.0 mm
- Radii: 50.0 – 300.0 mm
- Pitch: 45.0 mm
- Links per metre: 22 qty.
- Loading side: Inside bend

**ModulLine  
MP 30.1/.2  
MP 30.3/.4**

**open  
closed**  
Page 174

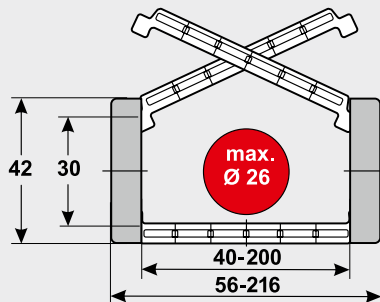

- Internal height: 30.0 mm
- Internal widths: 40.0 – 200.0 mm
- Radii: 60.0 – 300.0 mm
- Pitch: 50.0 mm
- Links per metre: 20 qty.
- Loading side: Inside or outside bend

**PowerLine  
MP 32.2  
MP 32.3**

**open  
closed**  
Page 186

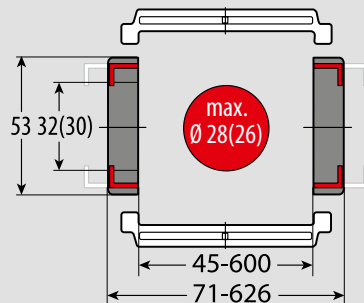

- Internal height: 32.0 mm
- Internal widths: 45.0 – 546.0 mm
- Radii: 80.0 – 250.0 mm
- Pitch: 64.5 mm
- Links per metre: 16 qty.
- Loading side: Inside and outside bend
- MP 32.3: inner widths 62–346 mm, radii 120-250 mm, lower inner height (values in brackets)

**MP Legacy  
MP 32**

**open**  
Page 330

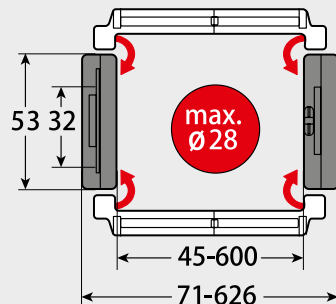

- Internal height: 32.0 mm
- Internal widths: 45.0 – 546.0 mm
- Radii: 80.0 – 250.0 mm
- Pitch: 64.5 mm
- Links per metre: 16 qty.
- Loading side: Inside and outside bend

- Travel distance gliding  $L_g$  max.: 60.0 m
- Travel distance self-supporting  $L_f$  max.: see diagram on page 101
- Travel distance vertical, hanging  $L_{vh}$  max.: 40.0 m
- Travel distance vertical, upright  $L_{vs}$  max.: 3.0 m
- Rotated 90°, unsupported  $L_{90f}$  max.: 0.7 m
- Speed, gliding  $V_g$  max.: 3.0 m/s
- Speed, self-supporting  $V_f$  max.: 6.0 m/s
- Acceleration, gliding  $a_g$  max.: 10.0 m/s<sup>2</sup>
- Acceleration, self-supporting  $a_f$  max.: 15.0 m/s<sup>2</sup>

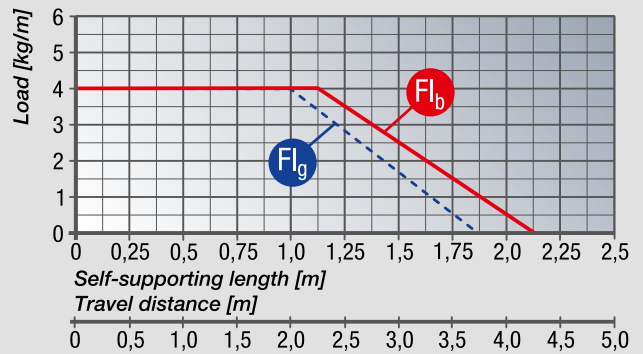

- Travel distance gliding  $L_g$  max.: 40.0 m
- Travel distance self-supporting  $L_f$  max.: see diagram on page 177
- Travel distance vertical, hanging  $L_{vh}$  max.: 30.0 m
- Travel distance vertical, upright  $L_{vs}$  max.: 3.0 m
- Rotated 90°, unsupported  $L_{90f}$  max.: 0.7 m
- Speed, gliding  $V_g$  max.: 3.0 m/s
- Speed, self-supporting  $V_f$  max.: 10.0 m/s
- Acceleration, gliding  $a_g$  max.: 10.0 m/s<sup>2</sup>
- Acceleration, self-supporting  $a_f$  max.: 15.0 m/s<sup>2</sup>

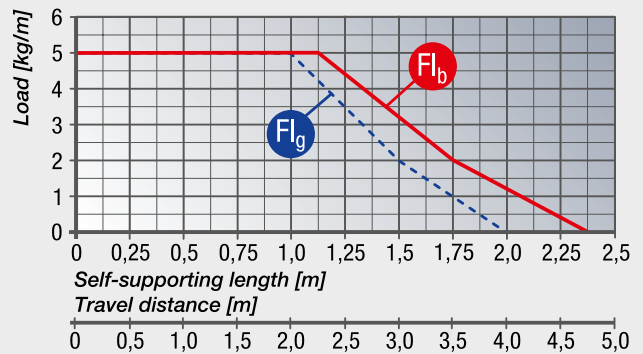

- Travel distance gliding  $L_g$  max.: 100.0 m
- Travel distance self-supporting  $L_f$  max.: see diagram on page 189
- Travel distance vertical, hanging  $L_{vh}$  max.: 40.0 m
- Travel distance vertical, upright  $L_{vs}$  max.: 5.0 m
- Rotated 90°, unsupported  $L_{90f}$  max.: 1.0 m
- Speed, gliding  $V_g$  max.: 5.0 m/s
- Speed, self-supporting  $V_f$  max.: 20.0 m/s
- Acceleration, gliding  $a_g$  max.: 25.0 m/s<sup>2</sup>
- Acceleration, self-supporting  $a_f$  max.: 30.0 m/s<sup>2</sup>

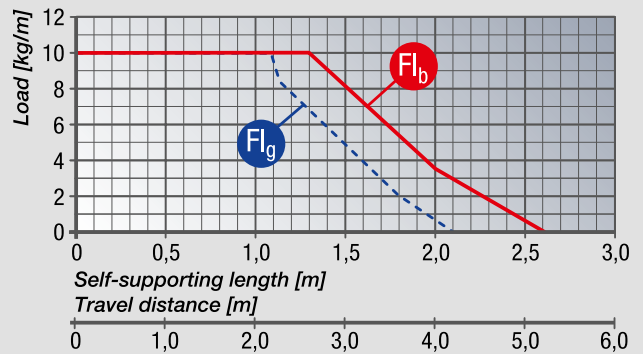

- Travel distance gliding  $L_g$  max.: 100.0 m
- Travel distance self-supporting  $L_f$  max.: see diagram on page 333
- Travel distance vertical, hanging  $L_{vh}$  max.: 40.0 m
- Travel distance vertical, upright  $L_{vs}$  max.: 5.0 m
- Rotated 90°, unsupported  $L_{90f}$  max.: 2.0 m
- Speed, gliding  $V_g$  max.: 5.0 m/s
- Speed, self-supporting  $V_f$  max.: 20.0 m/s
- Acceleration, gliding  $a_g$  max.: 25.0 m/s<sup>2</sup>
- Acceleration, self-supporting  $a_f$  max.: 30.0 m/s<sup>2</sup>

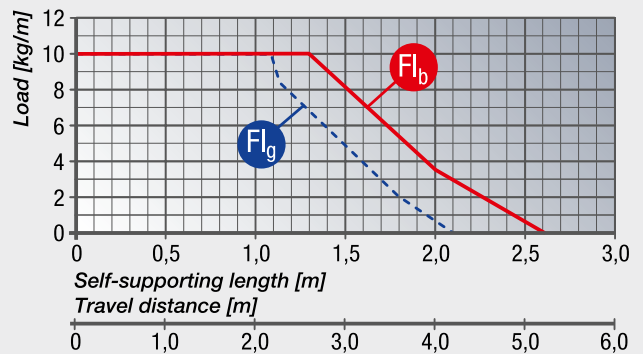

**MP Legacy**

**MP 35**

**open**

Page 344

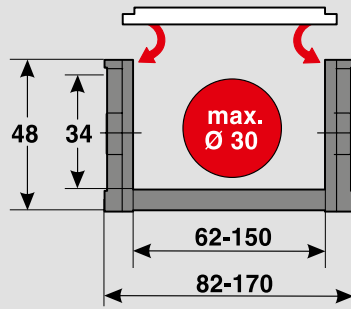

- Internal height: 34.0 mm
- Internal widths: 62.0 – 150.0 mm
- Radii: 70.0 – 300.0 mm
- Pitch: 58.0 mm
- Links per metre: 17 qty.
- Loading side: Inside bend

**MultiLine**

**MP 35.1**

**MP 35.2**

**open**

**open**

Page 114

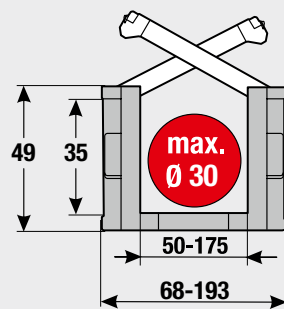

- Internal height: 35.0 mm
- Internal widths: 50.0 – 175.0 mm
- Radii: 63.0 – 250.0 mm
- Pitch: 56.0 mm
- Links per metre: 18 qty.
- Loading side: Inside or outside bend

**MultiLine**

**MP 36G**

**closed**

Page 126

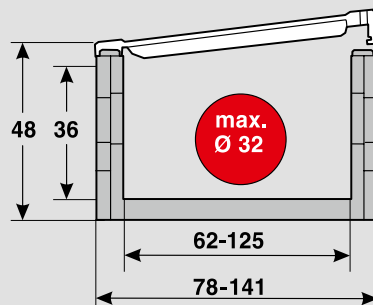

- Internal height: 36.0 mm
- Internal widths: 62.0 – 125.0 mm
- Radii: 80.0 – 200.0 mm
- Pitch: 40.0 mm
- Links per metre: 25 qty.
- Loading side: Inside bend

**MultiLine**

**MP 43G**

**closed**

Page 134

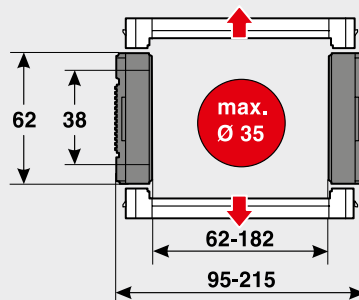

- Internal height: 38.0 mm
- Internal widths: 62.0 – 182.0 mm
- Radii: 125.0 – 400.0 mm
- Pitch: 75.5 mm
- Links per metre: 13 qty.
- Loading side: Inside and outside bend

- Travel distance gliding  $L_g$  max.: 80.0 m
- Travel distance self-supporting  $L_f$  max.: see diagram on page 347
- Travel distance vertical, hanging  $L_{vh}$  max.: 40.0 m
- Travel distance vertical, upright  $L_{vs}$  max.: 3.0 m
- Rotated 90°, unsupported  $L_{90f}$  max.: 1.0 m
- Speed, gliding  $V_g$  max.: 3.0 m/s
- Speed, self-supporting  $V_f$  max.: 10.0 m/s
- Acceleration, gliding  $a_g$  max.: 15.0 m/s<sup>2</sup>
- Acceleration, self-supporting  $a_f$  max.: 20.0 m/s<sup>2</sup>

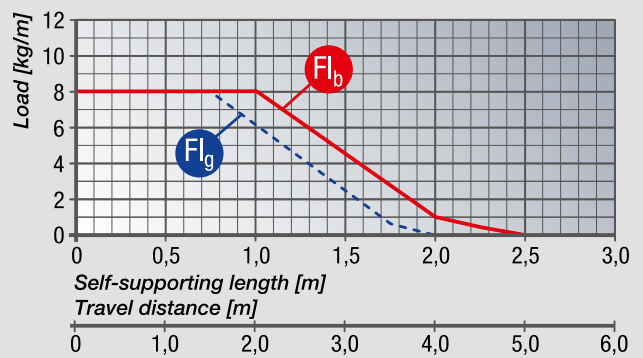

- Travel distance gliding  $L_g$  max.: 80.0 m
- Travel distance self-supporting  $L_f$  max.: see diagram on page 117
- Travel distance vertical, hanging  $L_{vh}$  max.: 50.0 m
- Travel distance vertical, upright  $L_{vs}$  max.: 3.0 m
- Rotated 90°, unsupported  $L_{90f}$  max.: 1.0 m
- Speed, gliding  $V_g$  max.: 5.0 m/s
- Speed, self-supporting  $V_f$  max.: 20.0 m/s
- Acceleration, gliding  $a_g$  max.: 15.0 m/s<sup>2</sup>
- Acceleration, self-supporting  $a_f$  max.: 50.0 m/s<sup>2</sup>

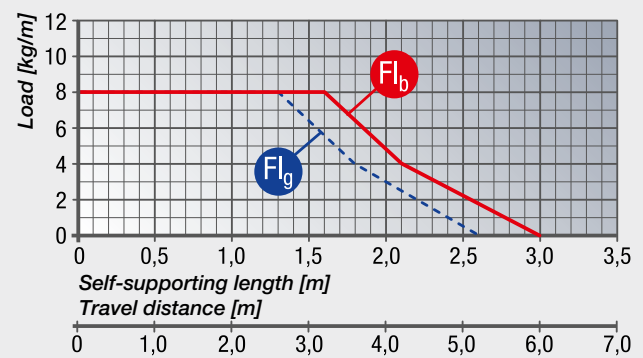

- Travel distance gliding  $L_g$  max.: 60.0 m
- Travel distance self-supporting  $L_f$  max.: see diagram on page 129
- Travel distance vertical, hanging  $L_{vh}$  max.: 30.0 m
- Travel distance vertical, upright  $L_{vs}$  max.: 3.0 m
- Rotated 90°, unsupported  $L_{90f}$  max.: 1.0 m
- Speed, gliding  $V_g$  max.: 3.0 m/s
- Speed, self-supporting  $V_f$  max.: 10.0 m/s
- Acceleration, gliding  $a_g$  max.: 15.0 m/s<sup>2</sup>
- Acceleration, self-supporting  $a_f$  max.: 20.0 m/s<sup>2</sup>

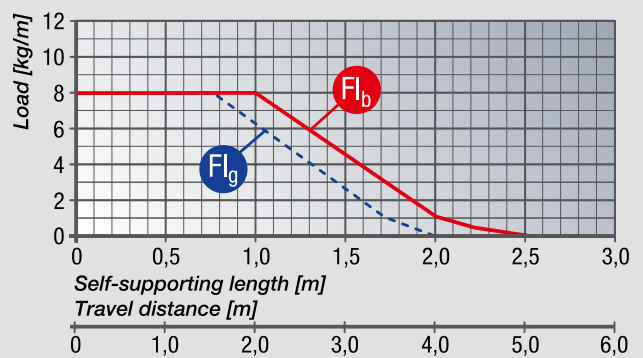

- Travel distance gliding  $L_g$  max.: 50.0 m
- Travel distance self-supporting  $L_f$  max.: see diagram on page 137
- Travel distance vertical, hanging  $L_{vh}$  max.: 40.0 m
- Travel distance vertical, upright  $L_{vs}$  max.: 3.0 m
- Rotated 90°, unsupported  $L_{90f}$  max.: 1.0 m
- Speed, gliding  $V_g$  max.: 5.0 m/s
- Speed, self-supporting  $V_f$  max.: 15.0 m/s
- Acceleration, gliding  $a_g$  max.: 15.0 m/s<sup>2</sup>
- Acceleration, self-supporting  $a_f$  max.: 20.0 m/s<sup>2</sup>

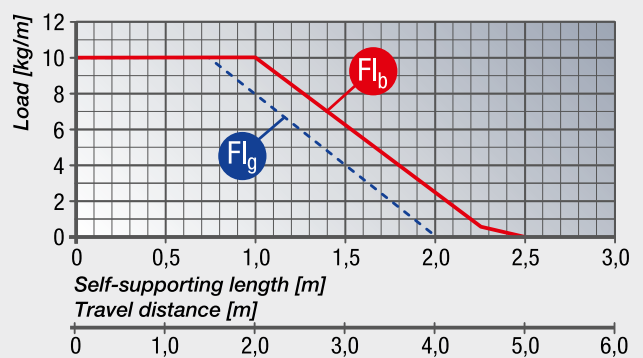

**MP Legacy**

**MP 44**

**open**

Page 366

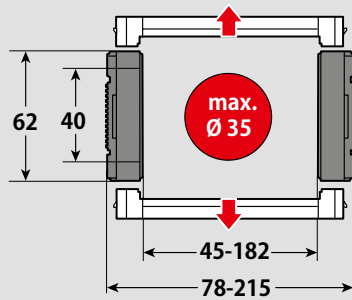

- Internal height: 40.0 mm
- Internal widths: 45.0 – 182.0 mm
- Radii: 90.0 – 400.0 mm
- Pitch: 75.5 mm
- Links per metre: 13 qty.
- Loading side: Inside and outside bend

**PowerLine**

**MP 41.2**

**MP 41.3**

**open**

**closed**

Page 202

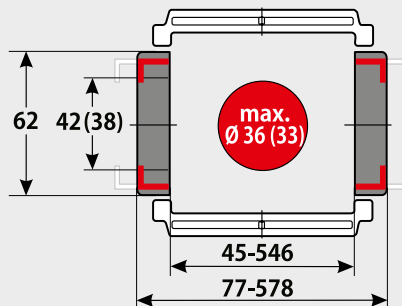

- Internal height: 42.0 mm
- Internal widths: 45.0 – 546.0 mm
- Radii: 90.0 – 350.0 mm
- Pitch: 77.0 mm
- Links per metre: 13 qty.
- Loading side: Inside and outside bend
- MP 41.3: inner widths 71–346 mm, radii 150-300 mm, lower inner height (values in brackets)

**MP Legacy**

**MP 41**

**open**

Page 352

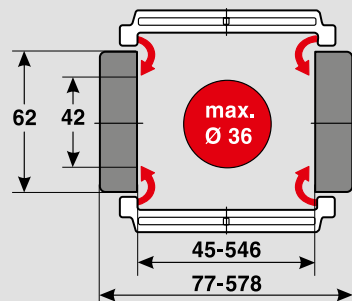

- Internal height: 42.0 mm
- Internal widths: 45.0 – 546.0 mm
- Radii: 90.0 – 350.0 mm
- Pitch: 77.0 mm
- Links per metre: 13 qty.
- Loading side: Inside and outside bend

**MultiLine**

**MP 45.1**

**MP 45.2**

**open**

**open**

Page 142

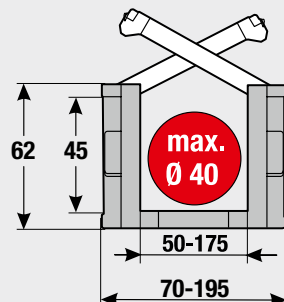

- Internal height: 45.0 mm
- Internal widths: 50.0 – 175.0
- Radii: 75.0 – 300.0
- Pitch: 67.0 mm
- Links per metre: 15 qty.
- Loading side: Inside or outside bend



- Travel distance gliding  $L_g$  max.: 50.0 m
- Travel distance self-supporting  $L_f$  max.: see diagram on page 369
- Travel distance vertical, hanging  $L_{vh}$  max.: 40.0 m
- Travel distance vertical, upright  $L_{vs}$  max.: 3.0 m
- Rotated 90°, unsupported  $L_{90f}$  max.: 1.0 m
- Speed, gliding  $V_g$  max.: 5.0 m/s
- Speed, self-supporting  $V_f$  max.: 15.0 m/s
- Acceleration, gliding  $a_g$  max.: 15.0 m/s<sup>2</sup>
- Acceleration, self-supporting  $a_f$  max.: 20.0 m/s<sup>2</sup>

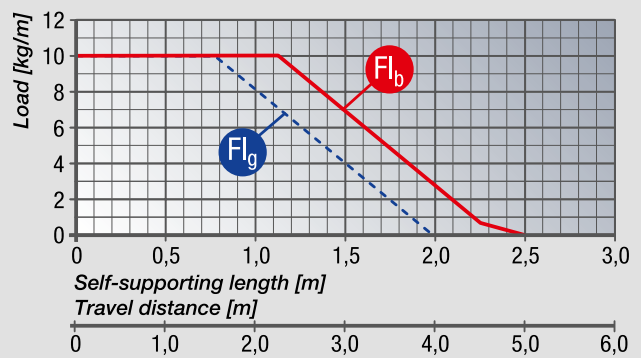

- Travel distance gliding  $L_g$  max.: 120.0 m
- Travel distance self-supporting  $L_f$  max.: see diagram on page 205
- Travel distance vertical, hanging  $L_{vh}$  max.: 50.0 m
- Travel distance vertical, upright  $L_{vs}$  max.: 6.0 m
- Rotated 90°, unsupported  $L_{90f}$  max.: 1.0 m
- Speed, gliding  $V_g$  max.: 5.0 m/s
- Speed, self-supporting  $V_f$  max.: 20.0 m/s
- Acceleration, gliding  $a_g$  max.: 25.0 m/s<sup>2</sup>
- Acceleration, self-supporting  $a_f$  max.: 30.0 m/s<sup>2</sup>

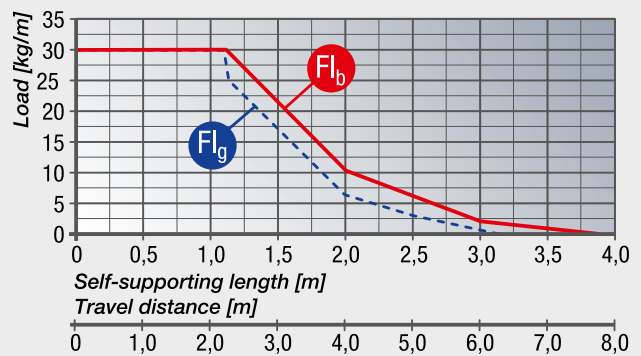

- Travel distance gliding  $L_g$  max.: 120.0 m
- Travel distance self-supporting  $L_f$  max.: see diagram on page 355
- Travel distance vertical, hanging  $L_{vh}$  max.: 50.0 m
- Travel distance vertical, upright  $L_{vs}$  max.: 6.0 m
- Rotated 90°, unsupported  $L_{90f}$  max.: 2.0 m
- Speed, gliding  $V_g$  max.: 5.0 m/s
- Speed, self-supporting  $V_f$  max.: 20.0 m/s
- Acceleration, gliding  $a_g$  max.: 25.0 m/s<sup>2</sup>
- Acceleration, self-supporting  $a_f$  max.: 30.0 m/s<sup>2</sup>

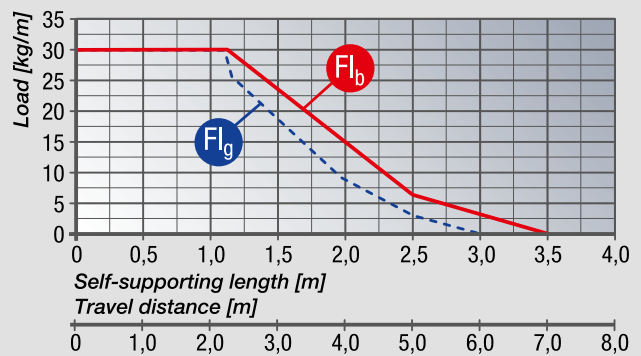

- Travel distance gliding  $L_g$  max.: 80.0 m
- Travel distance self-supporting  $L_f$  max.: see diagram on page 145
- Travel distance vertical, hanging  $L_{vh}$  max.: 60.0 m
- Travel distance vertical, upright  $L_{vs}$  max.: 4.0 m
- Rotated 90°, unsupported  $L_{90f}$  max.: 1.0 m
- Speed, gliding  $V_g$  max.: 5.0 m/s
- Speed, self-supporting  $V_f$  max.: 20.0 m/s
- Acceleration, gliding  $a_g$  max.: 15.0 m/s<sup>2</sup>
- Acceleration, self-supporting  $a_f$  max.: 50.0 m/s<sup>2</sup>

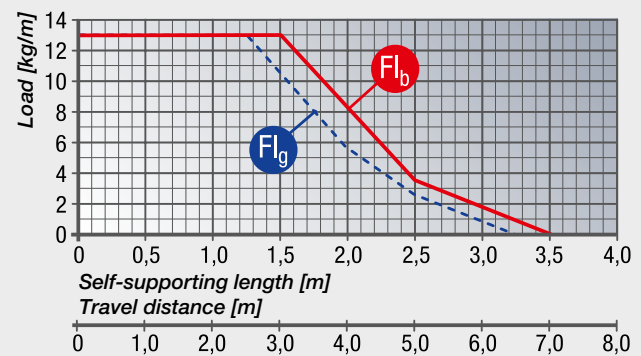

**PowerLine**  
**MP 52.2**  
**MP 52.3**  
**open**  
**closed**  
 Page 218

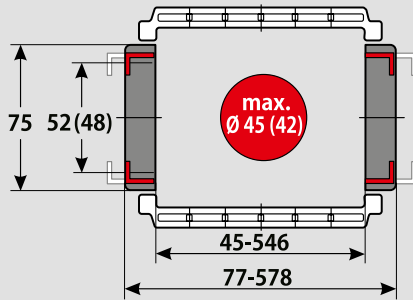

- Internal height: 52.0 mm
- Internal widths: 45.0 – 546.0 mm
- Radii: 100.0 – 350.0 mm
- Pitch: 91.0 mm
- Links per metre: 11 qty.
- Loading side: Inside and outside bend
- MP 52.3: inner widths 71–346 mm, radii 150-350 mm, lower inner height (values in brackets)

**PowerLine**  
**MP 52.2-D**  
**MP 52.3-D**  
**open**  
**closed**  
 Page 234

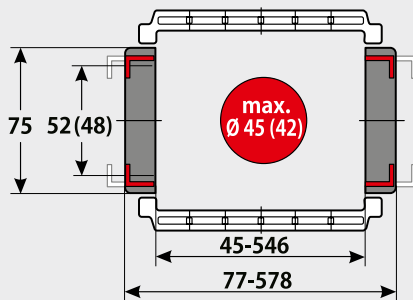

- Internal height: 52.0 mm
- Internal widths: 45.0 – 546.0
- Radii: 200.0
- Pitch: 91.0 mm
- Links per metre: 11 qty.
- Loading side: Inside and outside bend

**PowerLine**  
**MP 52.4**  
**MP 52.5**  
**open**  
**closed**  
 Page 250

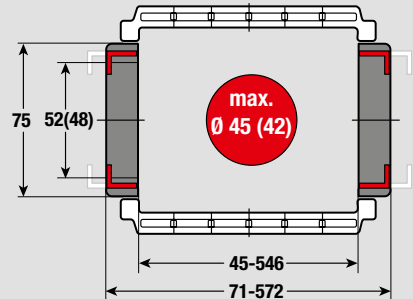

- Internal height: 52.0 mm
- Internal widths: 45.0 – 546.0
- Radii: 125.0 – 300.0
- Pitch: 91.0 mm
- Links per metre: 11 qty.
- Loading side: Inside and outside bend

**PowerLine**  
**MP 52.6**  
**MP 52.7**  
**open**  
**closed**  
 Page 266

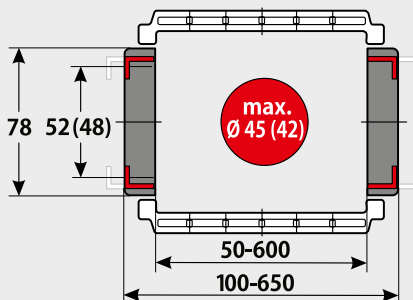

- Internal height: 52.0 mm
- Internal widths: 50.0 – 600.0 mm
- Radii: 150.0 – 300.0 mm
- Pitch: 91.0 mm
- Links per metre: 11 qty.
- Loading side: Inside and outside bend

- Travel distance gliding  $L_g$  max.: 150.0 m
- Travel distance self-supporting  $L_f$  max.: see diagram on page 221
- Travel distance vertical, hanging  $L_{vh}$  max.: 60.0 m
- Travel distance vertical, upright  $L_{vs}$  max.: 6.0 m
- Rotated 90°, unsupported  $L_{90f}$  max.: 2.0 m
- Speed, gliding  $V_g$  max.: 5.0 m/s
- Speed, self-supporting  $V_f$  max.: 20.0 m/s
- Acceleration, gliding  $a_g$  max.: 25.0 m/s<sup>2</sup>
- Acceleration, self-supporting  $a_f$  max.: 30.0 m/s<sup>2</sup>

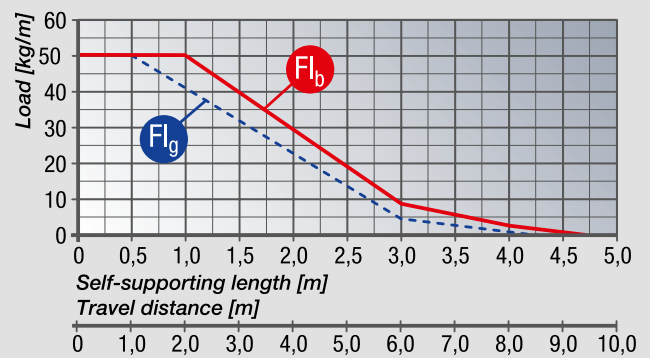

- Travel distance gliding  $L_g$  max.: 150.0 m
- Travel distance self-supporting  $L_f$  max.: see diagram on page 237
- Travel distance vertical, hanging  $L_{vh}$  max.: 60.0 m
- Travel distance vertical, upright  $L_{vs}$  max.: 6.0 m
- Rotated 90°, unsupported  $L_{90f}$  max.: 2.0 m
- Speed, gliding  $V_g$  max.: 5.0 m/s
- Speed, self-supporting  $V_f$  max.: 20.0 m/s
- Acceleration, gliding  $a_g$  max.: 25.0 m/s<sup>2</sup>
- Acceleration, self-supporting  $a_f$  max.: 30.0 m/s<sup>2</sup>

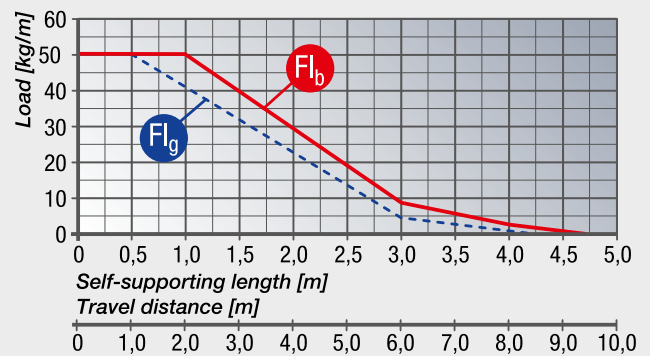

- Travel distance gliding  $L_g$  max.: 50.0 m
- Travel distance self-supporting  $L_f$  max.: see diagram on page 253
- Travel distance vertical, hanging  $L_{vh}$  max.: 50.0 m
- Travel distance vertical, upright  $L_{vs}$  max.: 4.0 m
- Rotated 90°, unsupported  $L_{90f}$  max.: 1.0 m
- Speed, gliding  $V_g$  max.: 5.0 m/s
- Speed, self-supporting  $V_f$  max.: 20.0 m/s
- Acceleration, gliding  $a_g$  max.: 25.0 m/s<sup>2</sup>
- Acceleration, self-supporting  $a_f$  max.: 30.0 m/s<sup>2</sup>

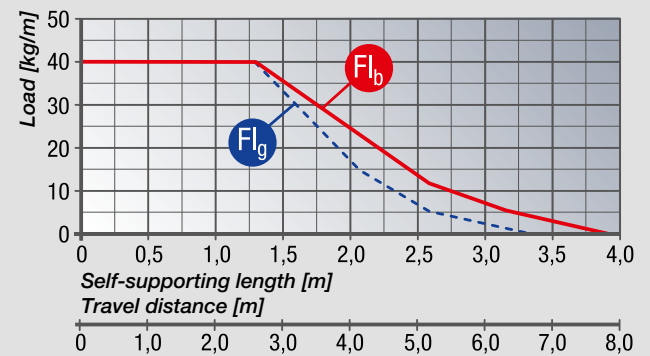

- Travel distance gliding  $L_g$  max.: 150.0 m
- Travel distance vertical, hanging  $L_{vh}$  max.: 80.0 m
- Travel distance vertical, upright  $L_{vs}$  max.: 6.0 m
- Rotated 90°, unsupported  $L_{90f}$  max.: 1.5 m
- Speed, gliding  $V_g$  max.: 6.0 m/s
- Acceleration, gliding  $a_g$  max.: 10.0 m/s<sup>2</sup>

**MP Legacy**

**MP 52.1**

**open**

Page 374

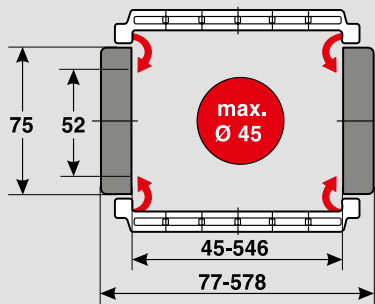

- Internal height: 52.0 mm
- Internal widths: 45.0 – 546.0 mm
- Radii: 100.0 – 350.0 mm
- Pitch: 91.0 mm
- Links per metre: 11 qty.
- Loading side: Inside and outside bend

**MultiLine**

**MP 65G**

**closed**

Page 154

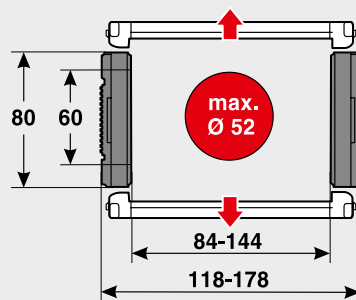

- Internal height: 60.0 mm
- Internal widths: 84.0 – 144.0 mm
- Radii: 200.0 – 400.0 mm
- Pitch: 91.5 mm
- Links per metre: 11 qty.
- Loading side: Inside and outside bend

**MP Legacy**

**MP 66**

**open**

Page 400

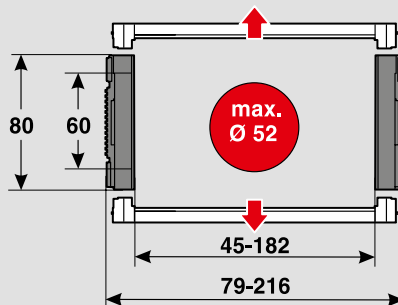

- Internal height: 60.0 mm
- Internal widths: 45.0 – 182.0 mm
- Radii: 150.0 – 400.0 mm
- Pitch: 91.5 mm
- Links per metre: 11 qty.
- Loading side: Inside and outside bend

**PowerLine**

**MP 62.4**

**open**

Page 276

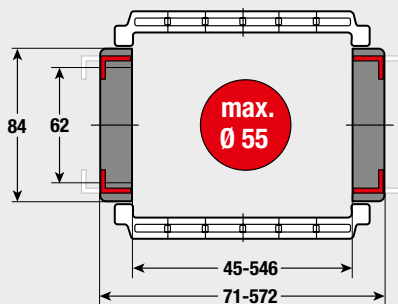

- Internal height: 62.0 mm
- Internal widths: 45.0 – 546.0 mm
- Radii: 135.0 – 300.0 mm
- Pitch: 91.0 mm
- Links per metre: 11 qty.
- Loading side: Inside and outside bend

- Travel distance gliding  $L_g$  max.: 150.0 m
- Travel distance self-supporting  $L_f$  max.: see diagram on page 377
- Travel distance vertical, hanging  $L_{vh}$  max.: 60.0 m
- Travel distance vertical, upright  $L_{vs}$  max.: 6.0 m
- Rotated 90°, unsupported  $L_{90f}$  max.: 3.0 m
- Speed, gliding  $V_g$  max.: 5.0 m/s
- Speed, self-supporting  $V_f$  max.: 20.0 m/s
- Acceleration, gliding  $a_g$  max.: 25.0 m/s<sup>2</sup>
- Acceleration, self-supporting  $a_f$  max.: 30.0 m/s<sup>2</sup>

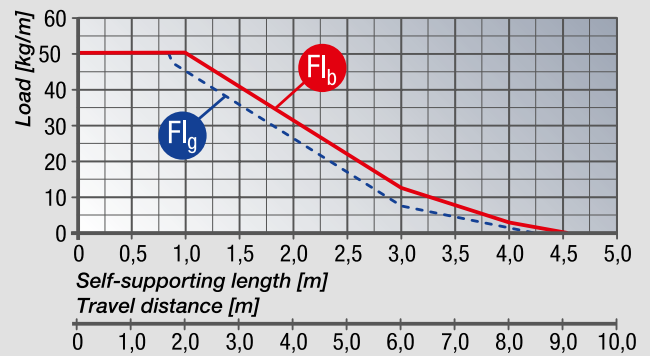

- Travel distance gliding  $L_g$  max.: 60.0 m
- Travel distance self-supporting  $L_f$  max.: see diagram on page 157
- Travel distance vertical, hanging  $L_{vh}$  max.: 50.0 m
- Travel distance vertical, upright  $L_{vs}$  max.: 5.0 m
- Rotated 90°, unsupported  $L_{90f}$  max.: 2.0 m
- Speed, gliding  $V_g$  max.: 5.0 m/s
- Speed, self-supporting  $V_f$  max.: 15.0 m/s
- Acceleration, gliding  $a_g$  max.: 15.0 m/s<sup>2</sup>
- Acceleration, self-supporting  $a_f$  max.: 20.0 m/s<sup>2</sup>

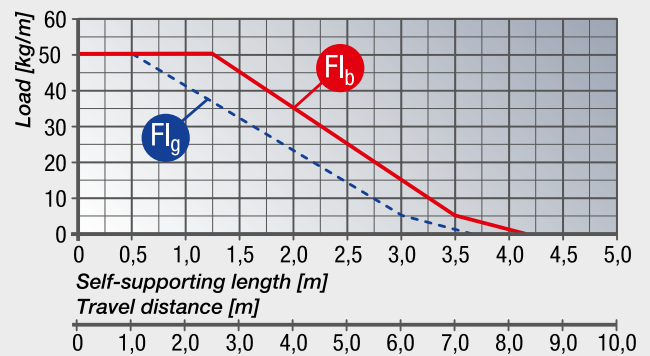

- Travel distance gliding  $L_g$  max.: 60.0 m
- Travel distance self-supporting  $L_f$  max.: see diagram on page 403
- Travel distance vertical, hanging  $L_{vh}$  max.: 50.0 m
- Travel distance vertical, upright  $L_{vs}$  max.: 5.0 m
- Rotated 90°, unsupported  $L_{90f}$  max.: 2.0 m
- Speed, gliding  $V_g$  max.: 5.0 m/s
- Speed, self-supporting  $V_f$  max.: 15.0 m/s
- Acceleration, gliding  $a_g$  max.: 15.0 m/s<sup>2</sup>
- Acceleration, self-supporting  $a_f$  max.: 20.0 m/s<sup>2</sup>

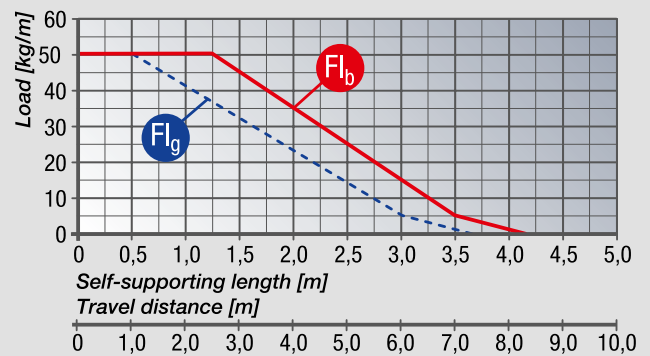

- Travel distance gliding  $L_g$  max.: 50.0 m
- Travel distance self-supporting  $L_f$  max.: see diagram on page 279
- Travel distance vertical, hanging  $L_{vh}$  max.: 50.0 m
- Travel distance vertical, upright  $L_{vs}$  max.: 4.0 m
- Rotated 90°, unsupported  $L_{90f}$  max.: 1.0 m
- Speed, gliding  $V_g$  max.: 5.0 m/s
- Speed, self-supporting  $V_f$  max.: 20.0 m/s
- Acceleration, gliding  $a_g$  max.: 25.0 m/s<sup>2</sup>
- Acceleration, self-supporting  $a_f$  max.: 30.0 m/s<sup>2</sup>

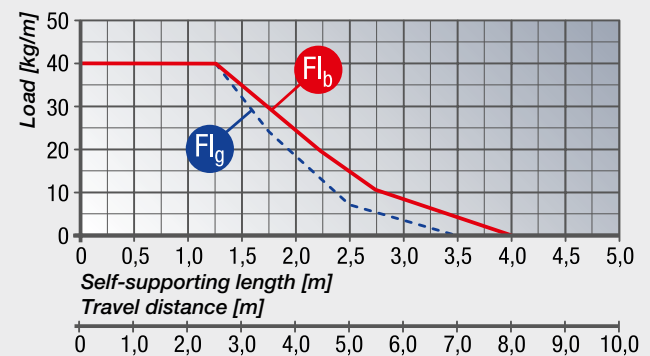

**HeavyLine**

**MP 62.2**

**MP 62.3**

**open**

**closed**

Page 290

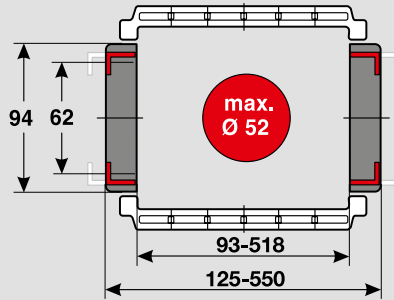

- Internal height: 62.0 mm
- Internal widths: 93.0 – 518.0 mm
- Radii: 150.0 – 500.0 mm
- Pitch: 100.0 mm
- Links per metre: 10 qty.
- Loading side: Inside and outside bend
- MP 62.3: inner widths 118–418 mm, radii 200–500 mm

**MP Legacy**

**MP 62.1**

**open**

Page 388

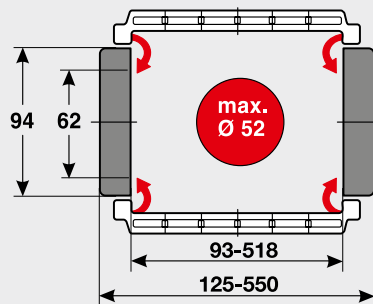

- Internal height: 62.0 mm
- Internal widths: 93.0 – 518.0 mm
- Radii: 150.0 – 500.0 mm
- Pitch: 100.0 mm
- Links per metre: 10 qty.
- Loading side: Inside and outside bend

**MP Legacy**

**MP 72**

**open**

Page 408

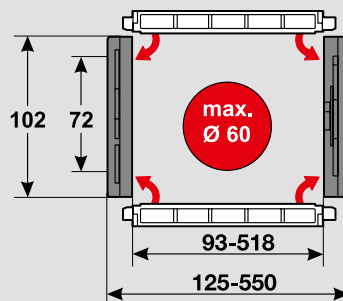

- Internal height: 72.0 mm
- Internal widths: 93.0 – 518.0 mm
- Radii: 150.0 – 500.0 mm
- Pitch: 100.0 mm
- Links per metre: 10 qty.
- Loading side: Inside and outside bend

**HeavyLine**

**MP 82.2**

**MP 82.3**

**open**

**closed**

Page 304

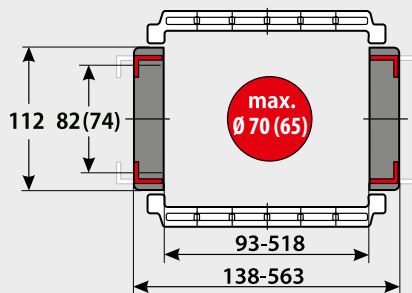

- Internal height: 82.0 mm
- Internal widths: 93.0 – 518.0 mm
- Radii: 150.0 – 650.0 mm
- Pitch: 118.0 mm
- Links per metre: 9 qty.
- Loading side: Inside and outside bend
- MP 82.3: inner widths 118–418 mm, radii 200–650 mm, lower inner height (values in brackets)

- Travel distance gliding  $L_g$  max.: 150.0 m
- Travel distance self-supporting  $L_f$  max.: see diagram on page 293
- Travel distance vertical, hanging  $L_{vh}$  max.: 65.0 m
- Travel distance vertical, upright  $L_{vs}$  max.: 6.0 m
- Rotated 90°, unsupported  $L_{90f}$  max.: 4.0 m
- Speed, gliding  $V_g$  max.: 5.0 m/s
- Speed, self-supporting  $V_f$  max.: 20.0 m/s
- Acceleration, gliding  $a_g$  max.: 25.0 m/s<sup>2</sup>
- Acceleration, self-supporting  $a_f$  max.: 40.0 m/s<sup>2</sup>

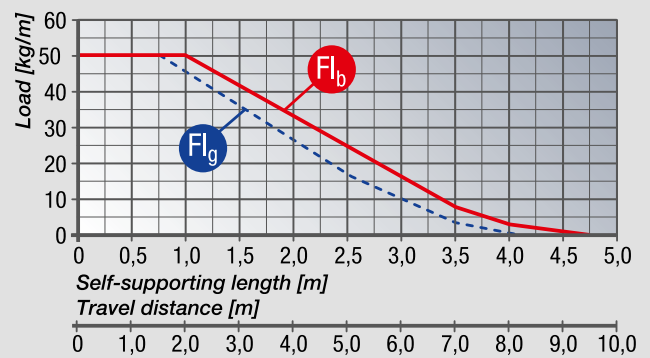

- Travel distance gliding  $L_g$  max.: 150.0 m
- Travel distance self-supporting  $L_f$  max.: see diagram on page 391
- Travel distance vertical, hanging  $L_{vh}$  max.: 65.0 m
- Travel distance vertical, upright  $L_{vs}$  max.: 6.0 m
- Rotated 90°, unsupported  $L_{90f}$  max.: 4.0 m
- Speed, gliding  $V_g$  max.: 5.0 m/s
- Speed, self-supporting  $V_f$  max.: 20.0 m/s
- Acceleration, gliding  $a_g$  max.: 25.0 m/s<sup>2</sup>
- Acceleration, self-supporting  $a_f$  max.: 40.0 m/s<sup>2</sup>

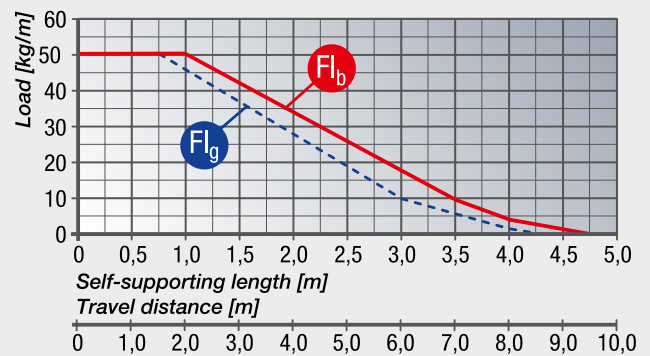

- Travel distance gliding  $L_g$  max.: 150.0 m
- Travel distance self-supporting  $L_f$  max.: see diagram on page 411
- Travel distance vertical, hanging  $L_{vh}$  max.: 80.0 m
- Travel distance vertical, upright  $L_{vs}$  max.: 6.0 m
- Rotated 90°, unsupported  $L_{90f}$  max.: 6.0 m
- Speed, gliding  $V_g$  max.: 5.0 m/s
- Speed, self-supporting  $V_f$  max.: 20.0 m/s
- Acceleration, gliding  $a_g$  max.: 25.0 m/s<sup>2</sup>
- Acceleration, self-supporting  $a_f$  max.: 40.0 m/s<sup>2</sup>

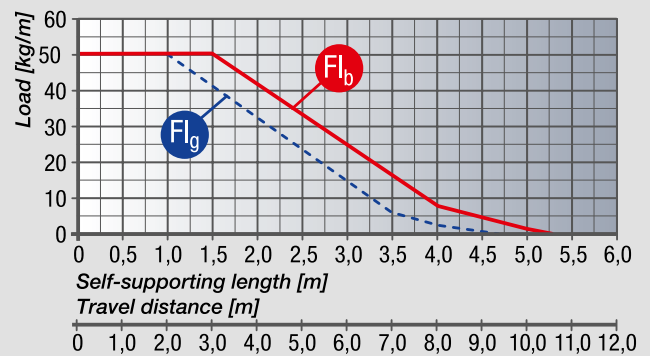

- Travel distance gliding  $L_g$  max.: 150.0 m
- Travel distance self-supporting  $L_f$  max.: see diagram on page 307
- Travel distance vertical, hanging  $L_{vh}$  max.: 80.0 m
- Travel distance vertical, upright  $L_{vs}$  max.: 6.0 m
- Rotated 90°, unsupported  $L_{90f}$  max.: 3.0 m
- Speed, gliding  $V_g$  max.: 5.0 m/s
- Speed, self-supporting  $V_f$  max.: 20.0 m/s
- Acceleration, gliding  $a_g$  max.: 25.0 m/s<sup>2</sup>
- Acceleration, self-supporting  $a_f$  max.: 40.0 m/s<sup>2</sup>

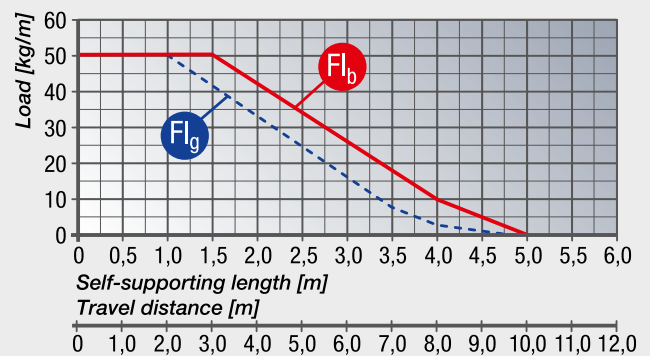

**HeavyLine**  
**MP 102.2**  
**open**  
 Page 318

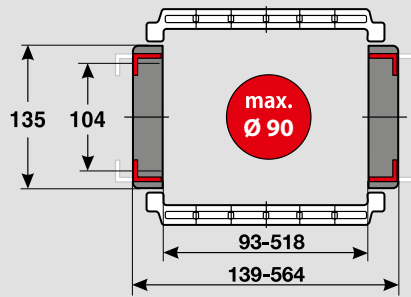

- Internal height: 104.0 mm
- Internal widths: 93.0 – 518.0 mm
- Radii: 250.0 – 500.0 mm
- Pitch: 141.0 mm
- Links per metre: 7 qty.
- Loading side: Inside and outside bend



- Travel distance gliding  $L_g$  max.: 150.0 m
- Travel distance self-supporting  $L_f$  max.: see diagram on page 321
- Travel distance vertical, hanging  $L_{vh}$  max.: 80.0 m
- Travel distance vertical, upright  $L_{vs}$  max.: 8.0 m
- Rotated 90°, unsupported  $L_{90f}$  max.: 8.0 m
- Speed, gliding  $V_g$  max.: 5.0 m/s
- Speed, self-supporting  $V_f$  max.: 20.0 m/s
- Acceleration, gliding  $a_g$  max.: 25.0 m/s<sup>2</sup>
- Acceleration, self-supporting  $a_f$  max.: 40.0 m/s<sup>2</sup>

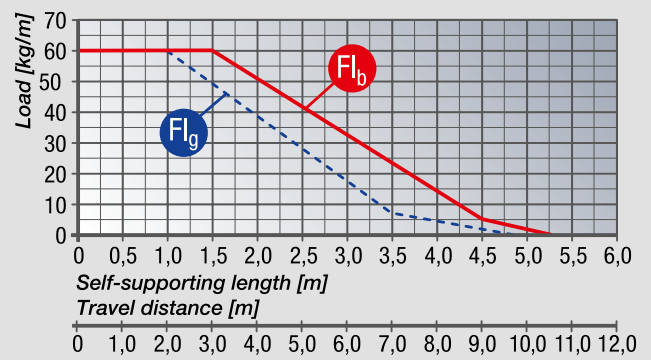

## MP 10.1 OPEN



- EASY (FILL) MECHANISM
- CHAIN BRACKET WITH INTEGRATED STRAIN RELIEF
- CAN BE EASILY SHORTENED AND LENGTHENED
- VERY FLEXIBLE, HIGH TORSION

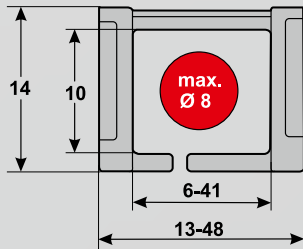

### TECHNICAL DATA

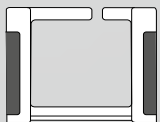

**Loading side**  
Outside bend slitted

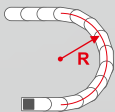

**Available radii**  
18.0 – 58.0 mm

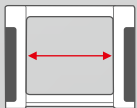

**Available interior widths**  
With plastic crossbar  
6.0 – 41.0 mm

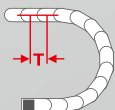

**Pitch**  
T = 15.0 mm



## TECHNICAL SPECIFICATIONS

Travel distance gliding $L_g$ max.	10.0 m
Travel distance self-supporting $L_s$ max.	see diagram on page 65
Travel distance vertical, hanging $L_{vh}$ max.	2.0 m
Travel distance vertical, upright $L_{vs}$ max.	1.0 m
Rotated 90°, unsupported $L_{90f}$ max.	not recommended
Speed, gliding $V_g$ max.	2.0 m/s
Speed, self-supporting $V_s$ max.	4.0 m/s
Acceleration, gliding $a_g$ max.	2.0 m/s <sup>2</sup>
Acceleration, self-supporting $a_s$ max.	2.0 m/s <sup>2</sup>

Contact our engineering department to meet any higher requirements: [efk@murrplastik.de](mailto:efk@murrplastik.de)

## MATERIAL PROPERTIES

Standard material	Polyamide (PA) black
Service temperature	-30.0 – 120.0 °C
Gliding friction factor	0.3
Static friction factor	0.45
Fire classification	Based on UL 94 HB

Other material properties on request.



## CHAIN BRACKET

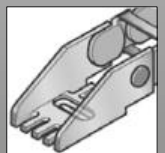

Chain bracket U-part

**ORDERING KEY**

Dimensions in mm [US inch]

Type code	Variation	Inside width	Outside width	Inside width	Outside width	Radius	Crossbar variant	Material	Chain length
0101 22	Crossbar on outside bend Crossbar on inside bend Slotted on outside bend	006 <sup>1)</sup> [0.24]	013 [0.51]			018 [0.71]	0 Plastic, full-ridged with bias	0 Polyamide standard (PA/black)	
		009 [0.35]	016 [0.63]						
		015 [0.59]	022 [0.87]						
		021 [0.83]	028 [1.10]			028 [1.10]		1 UL94 / V0 (PA/oxide red)	
		031 [1.22]	038 [1.50]			038 [1.50]		7 EMC (PA/light grey)	
		041 [1.61]	048 [1.89]			048 [1.89]		9 Special version (on request)	
						058 [2.28]			

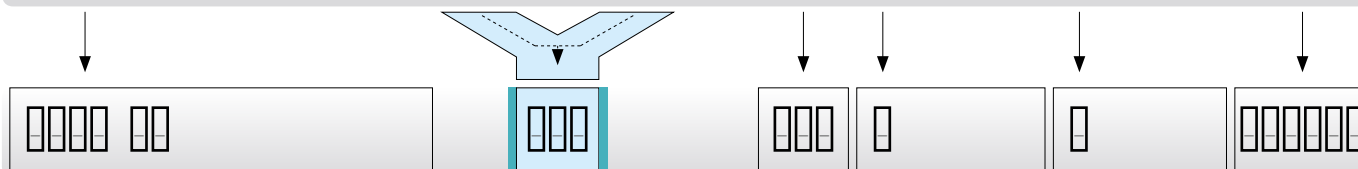

**ORDERING EXAMPLE: 0101 22 006 018 0 0 1065**

Crossbar on outside bend, crossbar on inside bend, slotted on outside bend  
 Inside width 6 mm; radius 18 mm  
 Plastic crossbar, full-ridged with bias, material black-coloured polyamide  
 Chain length 1065 mm (71 links)

<sup>1)</sup> max. line diameter 5 mm

**SELF-SUPPORTING LENGTH**

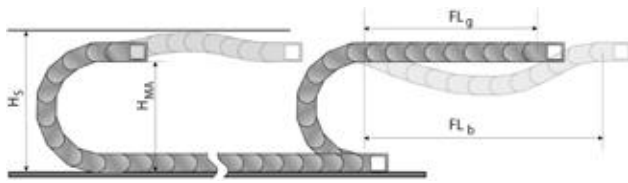

The self-supporting length is the distance between the chain bracket on the moving end and the start of the chain arch. The installation variant  $FL_g$  offers the lowest load and wear for the energy chain. The maximum travel parameters (speed and acceleration) can be applied for this variant.

- $H_s$  = Installation height plus safety
- $H_{MA}$  = Height of moving end connection
- $FL_g$  = Self-supporting length, upper run straight
- $FL_b$  = Self-supporting length, upper run bent

**LOAD DIAGRAM FOR SELF-SUPPORTING APPLICATIONS**

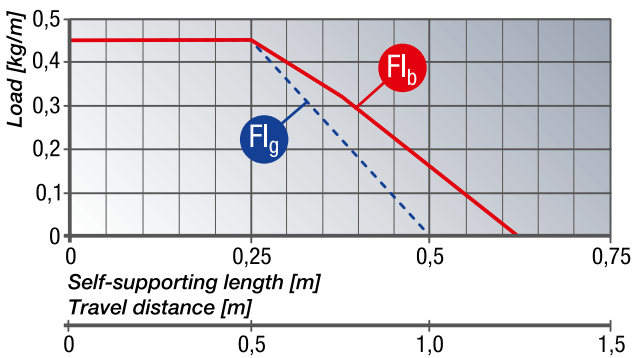

**$FL_g$  Self-supporting length, upper run straight**  
 In the  $FL_g$  range, the chain upper run still has a bias, is straight or has a maximum sag of 30.0 mm.

**$FL_b$  Self-supporting length, upper run bent**  
 In the  $FL_b$  range, the chain upper run has a sag of more than 30.0 mm, but this is still less than the maximum sag. Where the sag is greater than that permitted in the  $FL_b$  range, the application is critical and should be avoided. The self-supporting length can be optimised by using a support for the upper run or a more stable energy chain.

**DETERMINING THE CHAIN LENGTH**

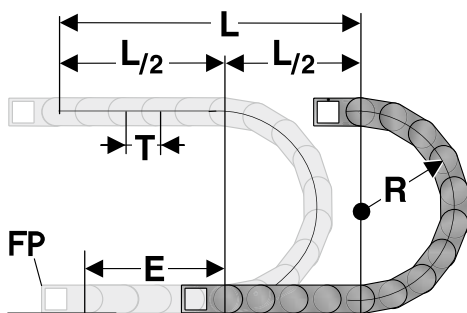

The fixed point of the energy chain should be connected in the middle of the travel distance. This arrangement gives the shortest connection between the fixed point and the moving consumer and thus the most efficient chain length.

Chain length calculation =  $L/2 + \pi * R + 2 * T + E$   
 $\approx 1 \text{ m chain} = 67 \text{ qty. } \times 15.0 \text{ mm.}$

- E = Distance between entry point and middle of travel distance
- L = Travel distance
- R = Radius
- P = Pitch 15.0 mm

**INSTALLATION DIMENSIONS**

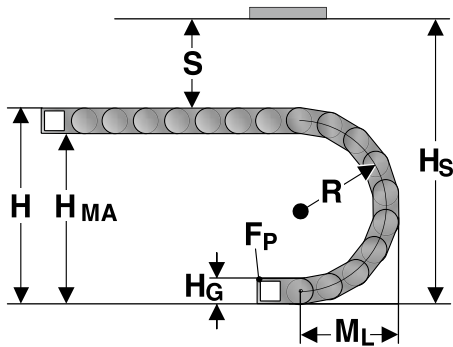

The moving end chain connection is to be screw fixed at height  $H_{MA}$  for the respective radius.  
For the installed dimension the "Installed height  $H_S$ " value has to be taken into account.

Radius R	18	28	38	48	58
Outside height of chain link ( $H_e$ )	14	14	14	14	14
Height of bend (H)	50	70	90	110	130
Height of moving end bracket ( $H_{MA}$ )	36	56	76	96	116
Safety margin (S)	10	10	10	10	10
Installation height ( $H_s$ )	60	80	100	120	140
Arc projection ( $M_L$ )	40	50	60	70	80

**MP 10.1 CHAMBER SIZE**

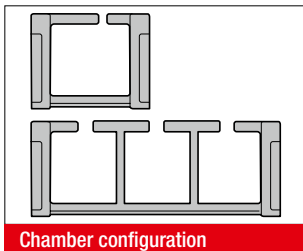

Chamber configuration

Depending on chain width, the MP10.1 is fitted with one, two, three or four chambers. This system of chambers enables cabling to be laid separately.

Type	Number of chambers qty.	Chamber width mm
10.1 006	1	6.5
10.1 009	1	9.5
10.1 015	1	15.5
10.1 021	2	9.5
10.1 031	3	9.5
10.1 041	4	9.0

**WIRE INSERTION AID**

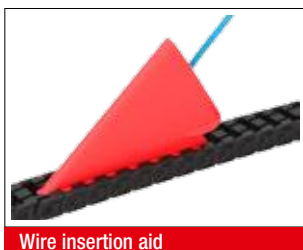

Wire insertion aid

The wire insertion tool allows for quick and simple installation of cables and conduits into the cable drag chain.

Type	Order No.
KE	83729010

**KA 10.1 CHAIN BRACKET U-PART**

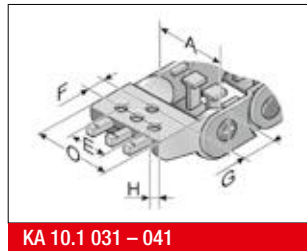
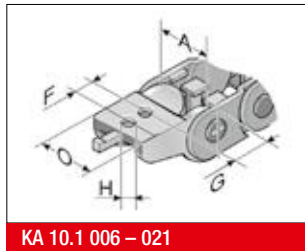

The chain bracket is an all-plastic part. The bracket is precisely adjusted to the respective chain width and only needs to be snapped in at the chain link. Please order one male and one female end bracket for each chain. The brackets should be fastened with M3 screws. The cables or conduits may be fastened with cable ties on the integrated strain relief of the chain bracket.

Type	Order No.	Material	Inside width					Outside width of KA 0 mm
			A mm	E mm	F mm	G mm	HØ mm	
KA 10.1 006 Female end	010100005000	Plastic	6.0		8.0	11.0	3.2	A+7.0
KA 10.1 006 Male end	010100005100	Plastic	6.0		8.0	11.0	3.2	A+7.0
KA 10.1 009 Female end	010100005200	Plastic	9.0		8.0	11.0	3.2	A+7.0
KA 10.1 009 Male end	010100005300	Plastic	9.0		8.0	11.0	3.2	A+7.0
KA 10.1 015 Female end	010100005400	Plastic	15.0		8.0	11.0	3.2	A+7.0
KA 10.1 015 Male end	010100005500	Plastic	15.0		8.0	11.0	3.2	A+7.0
KA 10.1 021 Female end	010100005600	Plastic	21.0		8.0	11.0	3.2	A+7.0
KA 10.1 021 Male end	010100005700	Plastic	21.0		8.0	11.0	3.2	A+7.0
KA 10.1 031 Female end	010100005800	Plastic	31.0	A-9.0	8.0	11.0	3.2	A+7.0
KA 10.1 031 Male end	010100005900	Plastic	31.0	A-9.0	8.0	11.0	3.2	A+7.0
KA 10.1 041 Female end	010100006000	Plastic	41.0	A-9.0	8.0	11.0	3.2	A+7.0
KA 10.1 041 Male end	010100006100	Plastic	41.0	A-9.0	8.0	11.0	3.2	A+7.0

**ASSEMBLY**

**DISASSEMBLY**

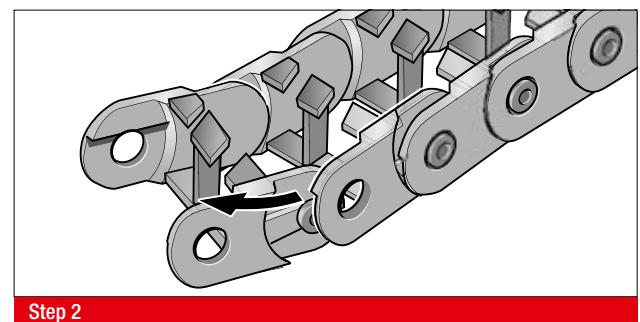
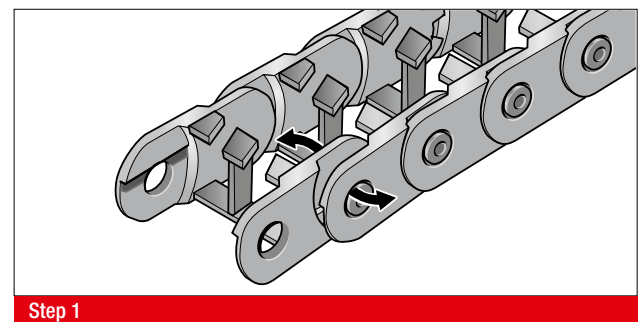
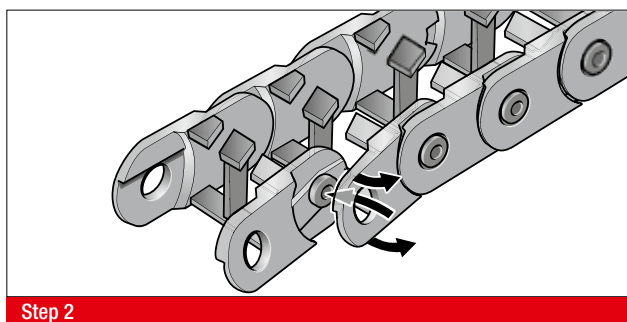
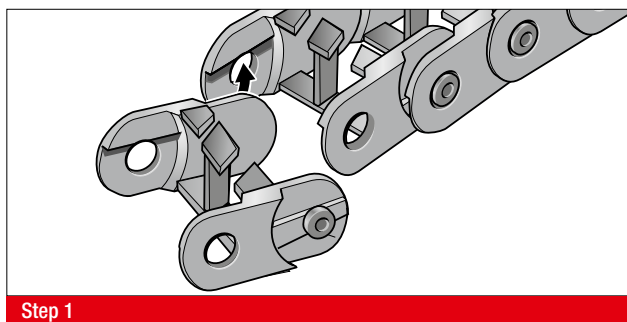

## MP 14 OPEN



- LOW-COST VARIANT
- CHAIN BRACKET WITH INTEGRATED STRAIN RELIEF
- CAN BE EASILY SHORTENED AND LENGTHENED

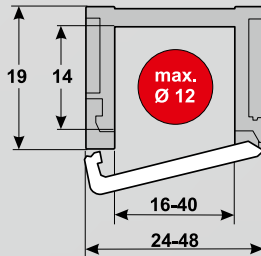

### TECHNICAL DATA

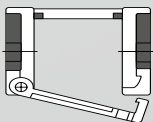

**Loading side**  
Outside bend

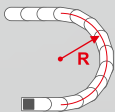

**Available radii**  
25.0 – 75.0 mm

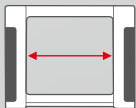

**Available interior widths**  
With plastic crossbar  
16.0 – 40.0 mm

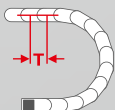

**Pitch**  
T = 26.0 mm

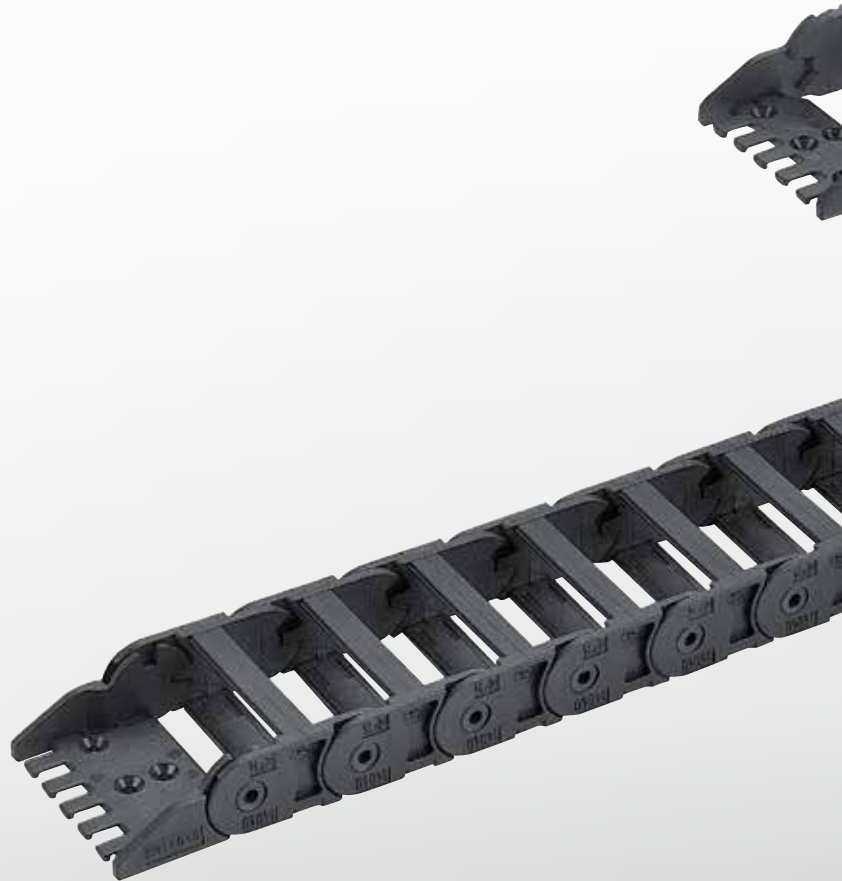





## TECHNICAL SPECIFICATIONS

Travel distance gliding $L_g$ max.	12.0 m
Travel distance self-supporting $L_s$ max.	see diagram on page 71
Travel distance vertical, hanging $L_{vh}$ max.	3.0 m
Travel distance vertical, upright $L_{vs}$ max.	2.0 m
Rotated 90°, unsupported $L_{90f}$ max.	not recommended
Speed, gliding $V_g$ max.	2.0 m/s
Speed, self-supporting $V_f$ max.	4.0 m/s
Acceleration, gliding $a_g$ max.	2.0 m/s <sup>2</sup>
Acceleration, self-supporting $a_s$ max.	2.0 m/s <sup>2</sup>

Contact our engineering department to meet any higher requirements: [efk@murrplastik.de](mailto:efk@murrplastik.de)

## MATERIAL PROPERTIES

Standard material	Polyamide (PA) black
Service temperature	-30.0 – 120.0 °C
Gliding friction factor	0.3
Static friction factor	0.45
Fire classification	Based on UL 94 HB

Other material properties on request.

### CHAIN BRACKET

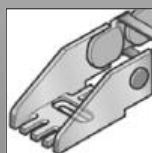

Chain bracket U-part

### SHELVING SYSTEM

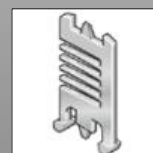

Separator TR

### GUIDE CHANNELS



VAW aluminium

**ORDERING KEY**

Dimensions in mm [US inch]

Type code	Variation	Inside width	Outside width	Inside width	Outside width	Radius	Crossbar variant	Material	Chain length
<b>0140 01</b>	Crossbar on outside bend Crossbar on inside bend Opens on outside bend	<b>016</b> [0.63]	<b>024</b> [0.94]			<b>025</b> [0.98]	<b>0</b> Plastic, full-ridged with bias	<b>0</b> Polyamide standard (PA/black)	
		<b>020</b> [0.79]	<b>028</b> [1.10]						
		<b>030</b> [1.18]	<b>038</b> [1.50]			<b>038</b> [1.50]			
		<b>040</b> [1.57]	<b>048</b> [1.89]						
					<b>048</b> [1.89]				
						<b>075</b> [2.95]			

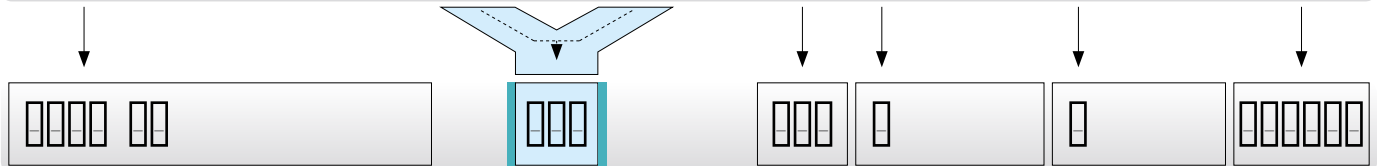

**ORDERING EXAMPLE: 0140 01 020 048 0 0 988**

Crossbar on inside and outside bend; can be opened on outside bend  
 Inside width 20 mm; radius 48 mm  
 Full-ridged with bias, material black-coloured polyamide  
 Chain length 988 mm (38 links)

**SELF-SUPPORTING LENGTH**

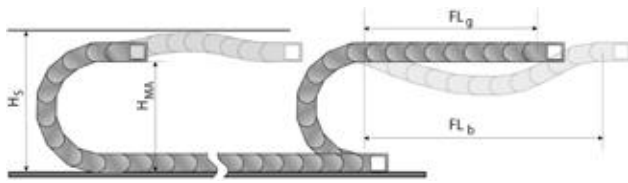

The self-supporting length is the distance between the chain bracket on the moving end and the start of the chain arch. The installation variant  $FL_g$  offers the lowest load and wear for the energy chain. The maximum travel parameters (speed and acceleration) can be applied for this variant.

- $H_S$  = Installation height plus safety
- $H_{MA}$  = Height of moving end connection
- $FL_g$  = Self-supporting length, upper run straight
- $FL_b$  = Self-supporting length, upper run bent

**LOAD DIAGRAM FOR SELF-SUPPORTING APPLICATIONS**

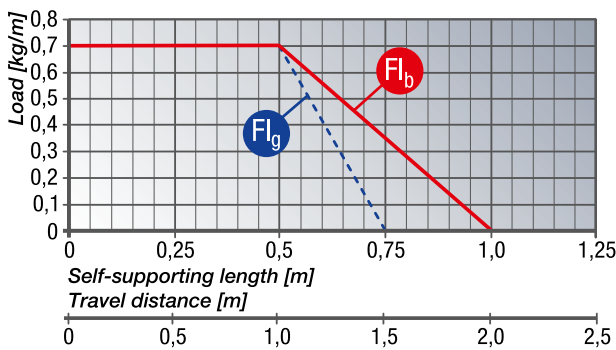

**$FL_g$  Self-supporting length, upper run straight**  
 In the  $FL_g$  range, the chain upper run still has a bias, is straight or has a maximum sag of 30.0 mm.

**$FL_b$  Self-supporting length, upper run bent**  
 In the  $FL_b$  range, the chain upper run has a sag of more than 30.0 mm, but this is still less than the maximum sag. Where the sag is greater than that permitted in the  $FL_b$  range, the application is critical and should be avoided. The self-supporting length can be optimised by using a support for the upper run or a more stable energy chain.

**DETERMINING THE CHAIN LENGTH**

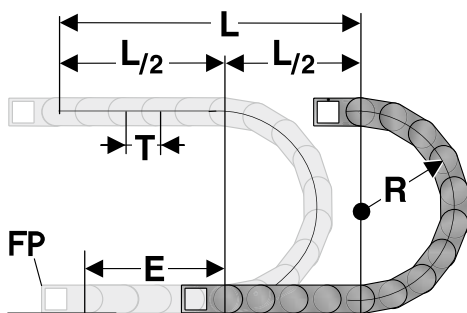

The fixed point of the energy chain should be connected in the middle of the travel distance. This arrangement gives the shortest connection between the fixed point and the moving consumer and thus the most efficient chain length.

Chain length calculation =  $L/2 + \pi * R + 2 * T + E$   
 $\approx 1 \text{ m chain} = 39 \text{ qty. } \times 26.0 \text{ mm.}$

- E = Distance between entry point and middle of travel distance
- L = Travel distance
- R = Radius
- P = Pitch 26.0 mm

**INSTALLATION DIMENSIONS**

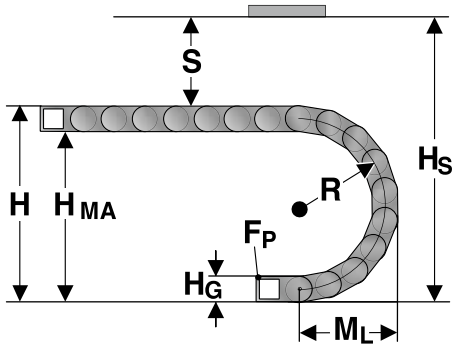

The moving end chain connection is to be screw fixed at height  $H_{MA}$  for the respective radius.  
For the installed dimension the “Installed height  $H_S$ ” value has to be taken into account.

Radius R	25	38	48	75
Outside height of chain link ( $H_G$ )	19	19	19	19
Height of bend (H)	69	95	115	169
Height of moving end bracket ( $H_{MA}$ )	50	76	96	150
Safety margin (S)	20	20	20	20
Installation height ( $H_S$ )	89	115	135	189
Arc projection ( $M_L$ )	61	74	84	111

**KA 14 / 15 CHAIN BRACKET U-PART**

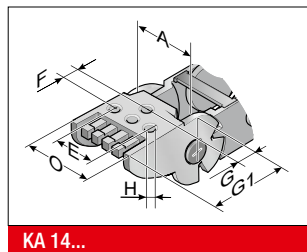
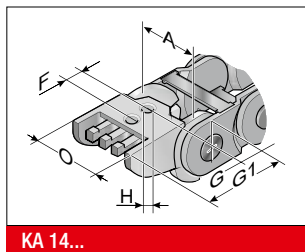

The chain bracket is an all-plastic part. The bracket is precisely adjusted to the respective chain width and only needs to be snapped in at the chain link. Please order one male and one female end bracket for each chain. The brackets should be fastened with M3 screws. The cables or conduits may be fastened with cable ties on the integrated strain relief of the chain bracket.

Type	Order No.	Material	Inside width						Outside width of KA O mm
			A mm	E mm	F mm	G mm	G1 mm	HØ mm	
KA 14016 Female end	014000005000	Plastic	16.0		8.0	11.0	30.5	3.2	A+8.0
KA 14016 Male end	014000005100	Plastic	16.0		8.0	7.5	30.5	3.2	A+8.0
KA 14020 Female end	014000005200	Plastic	20.0		8.0	11.0	30.5	3.2	A+8.0
KA 14020 Male end	014000005300	Plastic	20.0		8.0	7.5	30.5	3.2	A+8.0
KA 14030 Female end	014000005400	Plastic	30.0	A-8.0	8.0	11.0	30.5	3.2	A+8.0
KA 14030 Male end	014000005500	Plastic	30.0	A-8.0	8.0	7.5	30.5	3.2	A+8.0
KA 14040 Female end	014000005600	Plastic	40.0	A-8.0	8.0	11.0	30.5	3.2	A+8.0
KA 14040 Male end	014000005700	Plastic	40.0	A-8.0	8.0	7.5	30.5	3.2	A+8.0

**TR 14 SEPARATOR**

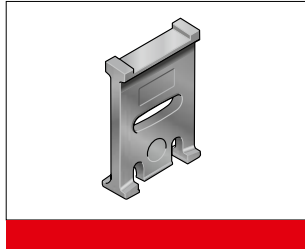
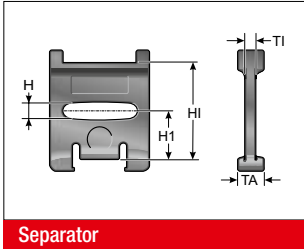

We recommend that separators be used if multiple round cables or conduits with differing diameters are to be installed.

Separator

Type	Order No.	Description	Version	TI mm	TA mm	HI mm
TR 14	014000009200	Separator	moveable	1.5	6.0	14.0

**GUIDE CHANNEL VAW (ALUMINIUM)**



VAW aluminium

A variable guide channel system, constructed from aluminium sections, is available for this energy chain. The variable guide channel ensures that the energy chain is supported and guided securely.

**ASSEMBLY**

**DISASSEMBLY**

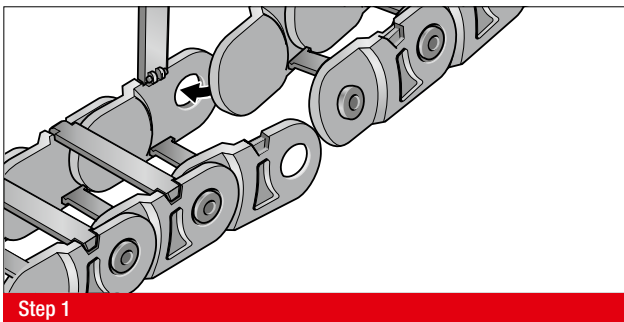

Step 1

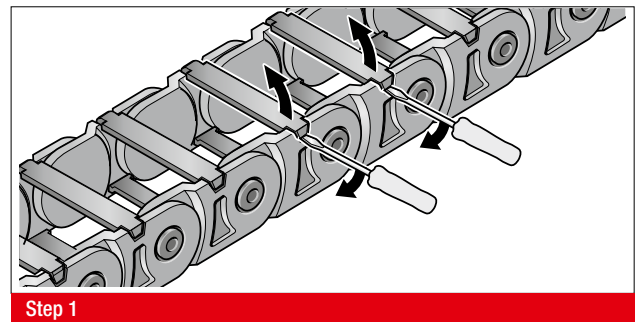

Step 1

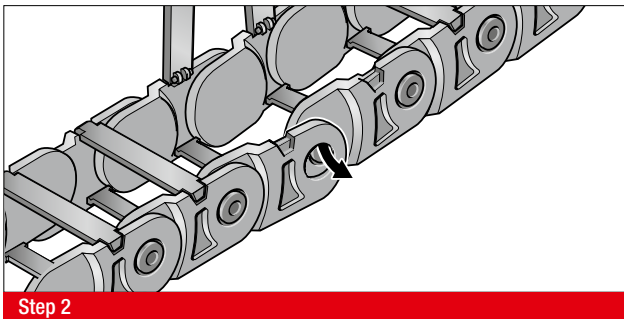

Step 2

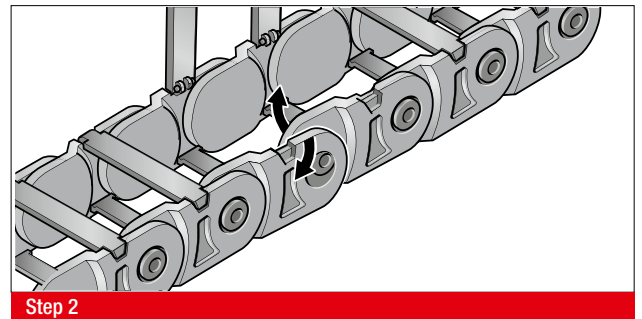

Step 2

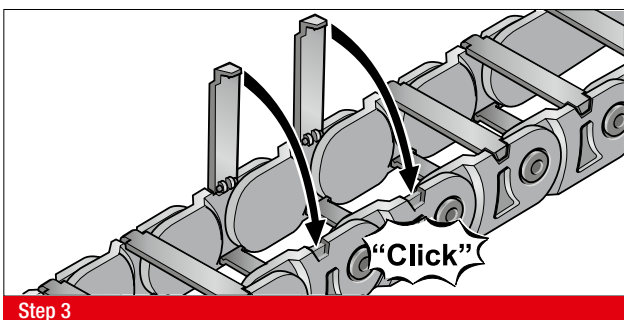

Step 3

## MP 15 OPEN



- LOW-COST VARIANT
- COMPACT DESIGN (NON-OPENING)
- CHAIN BRACKET WITH INTEGRATED STRAIN RELIEF
- CAN BE EASILY SHORTENED AND LENGTHENED
- NON-OPENING

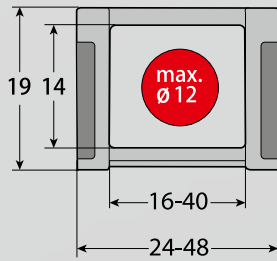

### TECHNICAL DATA

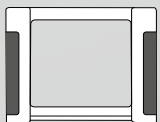

**Loading side**  
Non-opening

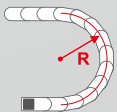

**Available radii**  
25.0 – 75.0 mm

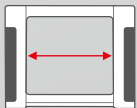

**Available interior widths**  
With plastic crossbar  
16.0 – 40.0 mm

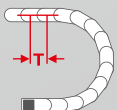

**Pitch**  
T = 26.0 mm



## TECHNICAL SPECIFICATIONS

Travel distance gliding $L_g$ max.	12.0 m
Travel distance self-supporting $L_f$ max.	see diagram on page 77
Travel distance vertical, hanging $L_{vh}$ max.	3.0 m
Travel distance vertical, upright $L_{vs}$ max.	2.0 m
Rotated 90°, unsupported $L_{90f}$ max.	not recommended
Speed, gliding $V_g$ max.	2.0 m/s
Speed, self-supporting $V_f$ max.	4.0 m/s
Acceleration, gliding $a_g$ max.	2.0 m/s <sup>2</sup>
Acceleration, self-supporting $a_f$ max.	2.0 m/s <sup>2</sup>

Contact our engineering department to meet any higher requirements: [efk@murrplastik.de](mailto:efk@murrplastik.de)



## MATERIAL PROPERTIES

Standard material	Polyamide (PA) black
Service temperature	-30.0 – 120.0 °C
Gliding friction factor	0.3
Static friction factor	0.45
Fire classification	Based on UL 94 HB

Other material properties on request.

### CHAIN BRACKET

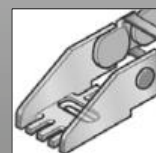

Chain bracket U-part

### GUIDE CHANNELS



VAW aluminium

**ORDERING KEY**

Dimensions in mm [US inch]

Type code	Variation	Inside width	Outside width	Inside width	Outside width	Radius	Crossbar variant	Material	Chain length
<b>0150 34</b>	Crossbar on outside bend Crossbar on inside bend Non-opening	<b>016</b> [0.63]	<b>024</b> [0.94]			<b>025</b> [0.98]	<b>0</b> Plastic, full-ridged with bias	<b>0</b> Polyamide standard (PA/black)	
		<b>020</b> [0.79]	<b>028</b> [1.10]						
		<b>030</b> [1.18]	<b>038</b> [1.50]			<b>038</b> [1.50]		<b>1</b> UL94 / V0 (PA/oxide red)	
		<b>040</b> [1.57]	<b>048</b> [1.89]						
						<b>048</b> [1.89]		<b>7</b> EMC (PA/light grey)	
						<b>075</b> [2.95]		<b>9</b> Special version (on request)	



**ORDERING EXAMPLE: 0150 34 016 025 0 0 1092**

Crossbar on outside bend, crossbar on inside bend, cannot be opened  
 Inside width 16 mm; radius 25 mm  
 Plastic crossbar, full-ridged with bias, material black-coloured polyamide  
 Chain length 1092 mm (42 links)



**SELF-SUPPORTING LENGTH**

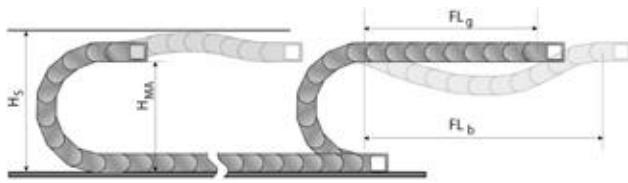

The self-supporting length is the distance between the chain bracket on the moving end and the start of the chain arch.  
 The installation variant  $FL_g$  offers the lowest load and wear for the energy chain.  
 The maximum travel parameters (speed and acceleration) can be applied for this variant.

- $H_s$  = Installation height plus safety
- $H_{MA}$  = Height of moving end connection
- $FL_g$  = Self-supporting length, upper run straight
- $FL_b$  = Self-supporting length, upper run bent

**LOAD DIAGRAM FOR SELF-SUPPORTING APPLICATIONS**

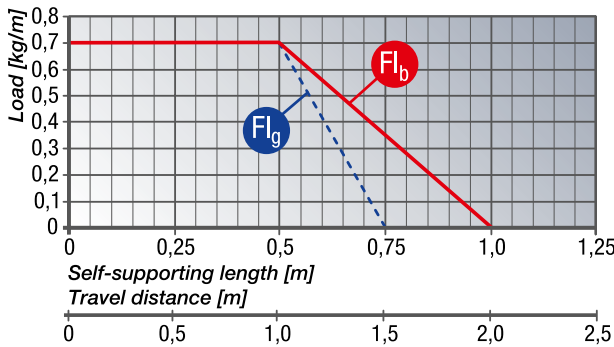

**$FL_g$  Self-supporting length, upper run straight**  
 In the  $FL_g$  range, the chain upper run still has a bias, is straight or has a maximum sag of 30.0 mm.

**$FL_b$  Self-supporting length, upper run bent**  
 In the  $FL_b$  range, the chain upper run has a sag of more than 30.0 mm, but this is still less than the maximum sag. Where the sag is greater than that permitted in the  $FL_b$  range, the application is critical and should be avoided. The self-supporting length can be optimised by using a support for the upper run or a more stable energy chain.

**DETERMINING THE CHAIN LENGTH**

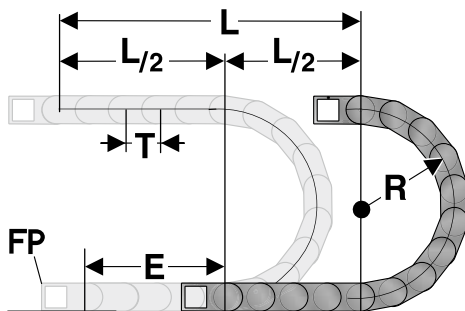

The fixed point of the energy chain should be connected in the middle of the travel distance.  
 This arrangement gives the shortest connection between the fixed point and the moving consumer and thus the most efficient chain length.

Chain length calculation =  $L/2 + \pi * R + 2 * T + E$   
 $\approx 1 \text{ m chain} = 39 \text{ qty. } \times 26.0 \text{ mm.}$

- E = Distance between entry point and middle of travel distance
- L = Travel distance
- R = Radius
- P = Pitch 26.0 mm

**INSTALLATION DIMENSIONS**

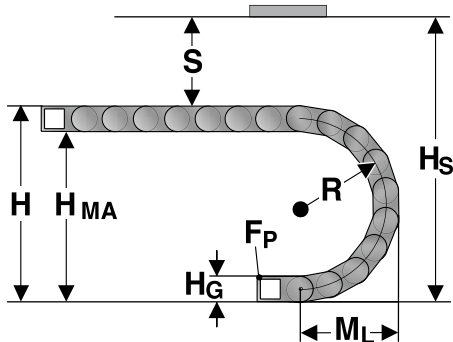

The moving end chain connection is to be screw fixed at height  $H_{MA}$  for the respective radius.  
For the installed dimension the “Installed height  $H_S$ ” value has to be taken into account.

Radius R	25	38	48	75
Outside height of chain link ( $H_G$ )	19	19	19	19
Height of bend (H)	69	95	115	169
Height of moving end bracket ( $H_{MA}$ )	50	76	96	150
Safety margin (S)	20	20	20	20
Installation height ( $H_S$ )	89	115	135	189
Arc projection ( $M_L$ )	61	74	84	111

**KA 14 / 15 CHAIN BRACKET U-PART**

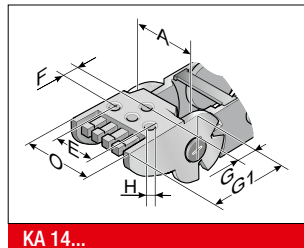
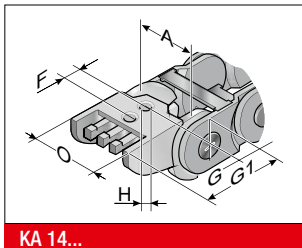

The chain bracket is an all-plastic part. The bracket is precisely adjusted to the respective chain width and only needs to be snapped in at the chain link. Please order one male and one female end bracket for each chain. The brackets should be fastened with M3 screws. The cables or conduits may be fastened with cable ties on the integrated strain relief of the chain bracket.

Type	Order No.	Material	Inside width						Outside width of KA O mm
			A mm	E mm	F mm	G mm	G1 mm	HØ mm	
KA 14016 Female end	014000005000	Plastic	16.0		8.0	11.0	30.5	3.2	A+8.0
KA 14016 Male end	014000005100	Plastic	16.0		8.0	7.5	30.5	3.2	A+8.0
KA 14020 Female end	014000005200	Plastic	20.0		8.0	11.0	30.5	3.2	A+8.0
KA 14020 Male end	014000005300	Plastic	20.0		8.0	7.5	30.5	3.2	A+8.0
KA 14030 Female end	014000005400	Plastic	30.0	A-8.0	8.0	11.0	30.5	3.2	A+8.0
KA 14030 Male end	014000005500	Plastic	30.0	A-8.0	8.0	7.5	30.5	3.2	A+8.0
KA 14040 Female end	014000005600	Plastic	40.0	A-8.0	8.0	11.0	30.5	3.2	A+8.0
KA 14040 Male end	014000005700	Plastic	40.0	A-8.0	8.0	7.5	30.5	3.2	A+8.0

**GUIDE CHANNEL VAW (ALUMINIUM)**



VAW aluminium

A variable guide channel system, constructed from aluminium sections, is available for this energy chain. The variable guide channel ensures that the energy chain is supported and guided securely.

**ASSEMBLY**

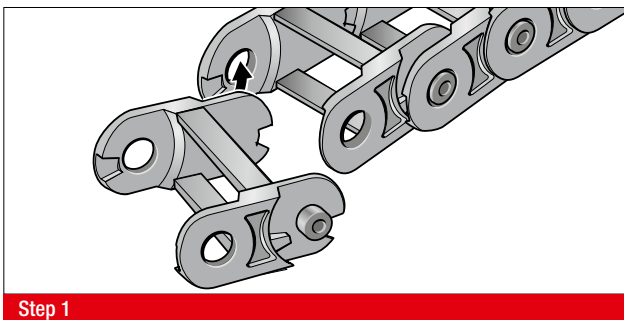

Step 1

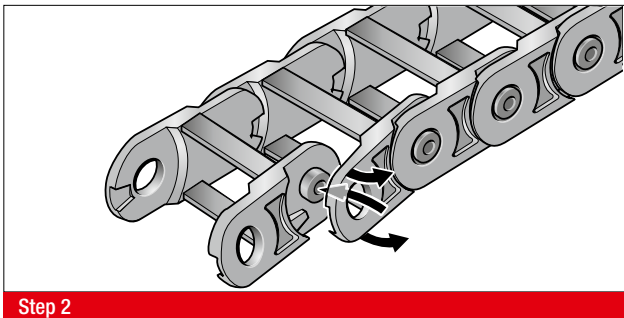

Step 2

**DISASSEMBLY**

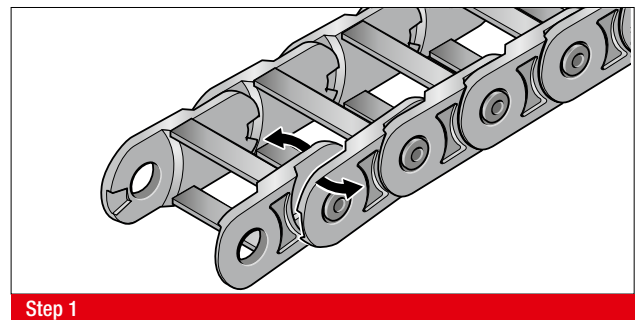

Step 1

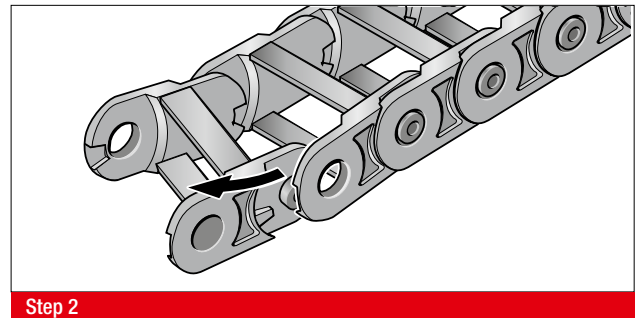

Step 2

**MP 18.1**  
OPEN



**MP 18.2**  
OPEN



- CHAIN BRACKET WITH INTEGRATED STRAIN RELIEF
- CAN BE EASILY SHORTENED AND LENGTHENED

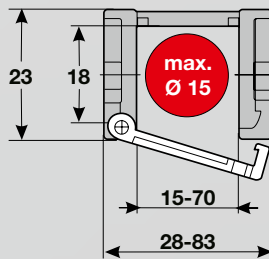

## TECHNICAL DATA

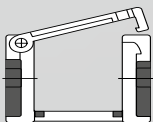

**Loading side**  
Inside or outside bend

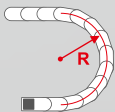

**Available radii**  
28.0 – 78.0 mm

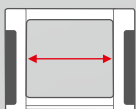

**Available interior widths**  
With plastic crossbar  
15.0 – 70.0 mm

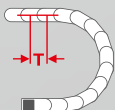

**Pitch**  
T = 33.0 mm



## TECHNICAL SPECIFICATIONS

Travel distance gliding $L_g$ max.	20.0 m
Travel distance self-supporting $L_s$ max.	see diagram on page 83
Travel distance vertical, hanging $L_{vh}$ max.	8.0 m
Travel distance vertical, upright $L_{vs}$ max.	3.0 m
Rotated 90°, unsupported $L_{90f}$ max.	0.5 m
Speed, gliding $V_g$ max.	2.0 m/s
Speed, self-supporting $V_s$ max.	5.0 m/s
Acceleration, gliding $a_g$ max.	5.0 m/s <sup>2</sup>
Acceleration, self-supporting $a_s$ max.	5.0 m/s <sup>2</sup>

Contact our engineering department to meet any higher requirements: [efk@murrplastik.de](mailto:efk@murrplastik.de)



## MATERIAL PROPERTIES

Standard material	Polyamide (PA) black
Service temperature	-30.0 – 120.0 °C
Gliding friction factor	0.3
Static friction factor	0.45
Fire classification	UL 94 HB

Other material properties on request.

### CHAIN BRACKET

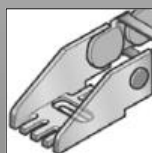

Chain bracket U-part

### SHELVING SYSTEM

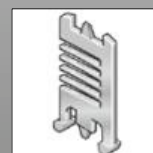

Separator TR

### GUIDE CHANNELS



VAW aluminium

**ORDERING KEY**

Dimensions in mm [US inch]

Type code	Variation	Inside width	Outside width	Inside width	Outside width	Radius	Crossbar variant	Material	Chain length																																						
0181 01 <sup>1)</sup>	MP 18.1 open Crossbar on outside bend Crossbar on inside bend Opens on outside bend	015 <sup>3)</sup> [0.59]	028 [1.10]			028 [1.10]	0 Plastic, full-ridged with bias	0 Polyamide standard (PA/black)																																							
		018 [0.71]	031 [1.22]							0182 02 <sup>2)</sup>	MP 18.2 open Crossbar on outside bend Crossbar on inside bend Opens on inside bend	025 [0.98]	038 [1.50]			038 [1.50]		1 UL94 / V0 (PA/oxide red)		037 [1.46]	050 [1.97]					050 [1.97]	063 [2.48]			048 [1.89]		5 Polypropylene (PP/blue)				070 [2.76]	083 [3.27]			078 [3.07]		7 EMC (PA/light grey)					
0182 02 <sup>2)</sup>	MP 18.2 open Crossbar on outside bend Crossbar on inside bend Opens on inside bend	025 [0.98]	038 [1.50]			038 [1.50]		1 UL94 / V0 (PA/oxide red)																																							
		037 [1.46]	050 [1.97]									050 [1.97]	063 [2.48]			048 [1.89]		5 Polypropylene (PP/blue)				070 [2.76]	083 [3.27]			078 [3.07]		7 EMC (PA/light grey)										9 Special version (on request)									
		050 [1.97]	063 [2.48]			048 [1.89]		5 Polypropylene (PP/blue)																																							
		070 [2.76]	083 [3.27]			078 [3.07]		7 EMC (PA/light grey)																																							
								9 Special version (on request)																																							

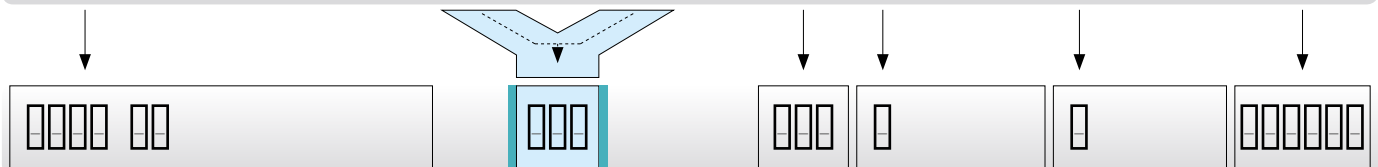

**ORDERING EXAMPLE: 0181 01 015 028 0 0 1122**

Crossbar on outside bend, crossbar on inside bend, can be opened from outside bend  
 Inside width 15 mm; radius 28 mm  
 Plastic crossbar, full-ridged with bias, material black-coloured polyamide  
 Chain length 1122 mm (34 links)

<sup>1)</sup> for Type 0181 only  
<sup>2)</sup> for Type 0182 only  
<sup>3)</sup> max. line diameter 13 mm

**SELF-SUPPORTING LENGTH**

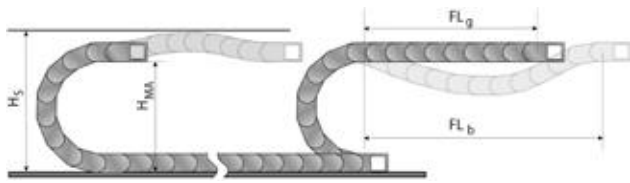

The self-supporting length is the distance between the chain bracket on the moving end and the start of the chain arch.  
 The installation variant  $FL_g$  offers the lowest load and wear for the energy chain.  
 The maximum travel parameters (speed and acceleration) can be applied for this variant.

- $H_s$  = Installation height plus safety
- $H_{MA}$  = Height of moving end connection
- $FL_g$  = Self-supporting length, upper run straight
- $FL_b$  = Self-supporting length, upper run bent

**LOAD DIAGRAM FOR SELF-SUPPORTING APPLICATIONS**

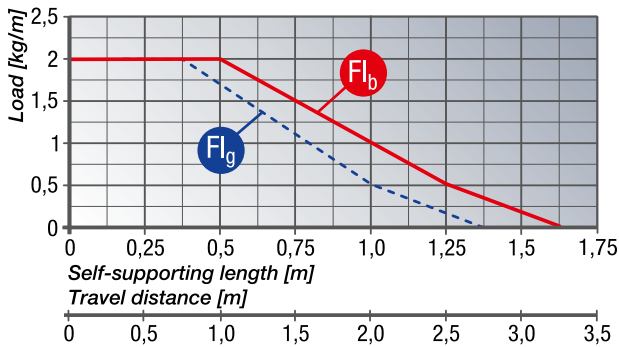

**$FL_g$  Self-supporting length, upper run straight**  
 In the  $FL_g$  range, the chain upper run still has a bias, is straight or has a maximum sag of 40.0 mm.

**$FL_b$  Self-supporting length, upper run bent**  
 In the  $FL_b$  range, the chain upper run has a sag of more than 40.0 mm, but this is still less than the maximum sag. Where the sag is greater than that permitted in the  $FL_b$  range, the application is critical and should be avoided. The self-supporting length can be optimised by using a support for the upper run or a more stable energy chain.

**DETERMINING THE CHAIN LENGTH**

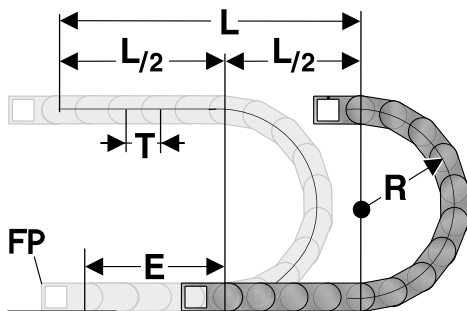

The fixed point of the energy chain should be connected in the middle of the travel distance.  
 This arrangement gives the shortest connection between the fixed point and the moving consumer and thus the most efficient chain length.

Chain length calculation =  $L/2 + \pi * R + 2 * T + E$   
 $\approx 1 \text{ m chain} = 30 \text{ qty. } \times 33.0 \text{ mm.}$

- E = Distance between entry point and middle of travel distance
- L = Travel distance
- R = Radius
- P = Pitch 33.0 mm

**INSTALLATION DIMENSIONS**

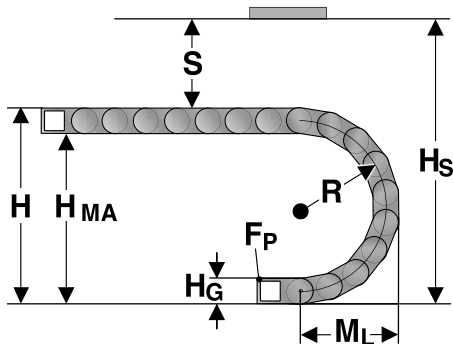

The moving end chain connection is to be screw fixed at height  $H_{MA}$  for the respective radius.  
For the installed dimension the “Installed height  $H_S$ ” value has to be taken into account.

Radius R	28	38	48	78
Outside height of chain link ( $H_G$ )	23	23	23	23
Height of bend (H)	79	99	119	179
Height of moving end bracket ( $H_{MA}$ )	56	76	96	156
Safety margin (S)	30	30	30	30
Installation height ( $H_S$ )	109	129	149	209
Arc projection ( $M_L$ )	73	83	93	123

**KA 18.1 / 18.2 CHAIN BRACKET U-PART**

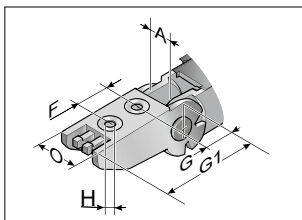

KA/Z 18015 – 025

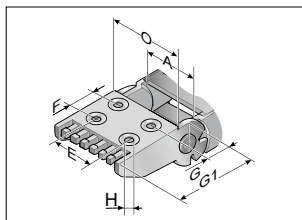

KA/Z 18037 – 070

The chain bracket is an all-plastic part. The bracket is precisely adjusted to the respective chain width and only needs to be snapped in at the chain link. Please order one male and one female end bracket for each chain. The brackets should be fastened with M5 screws. The cables or conduits may be fastened with cable ties on the integrated strain relief of the chain bracket.

Type	Order No.	Material	Inside width						Outside width of KA O mm
			A mm	E mm	F mm	G mm	G1 mm	H0 mm	
KA/Z 18015 female end	018100004800	Plastic	15.4		19.0	10.5	53.0	5.5	A+13.0
KA/Z 18015 male end	018100004900	Plastic	15.4		19.0	8.5	53.0	5.5	A+13.0
KA/Z 18018 female end	018100005000	Plastic	18.4		19.0	10.5	53.0	5.5	A+13.0
KA/Z 18018 male end	018100005100	Plastic	18.4		19.0	8.5	53.0	5.5	A+13.0
KA/Z 18025 female end	018100005200	Plastic	25.4		19.0	10.5	53.0	5.5	A+13.0
KA/Z 18025 male end	018100005300	Plastic	25.4		19.0	8.5	53.0	5.5	A+13.0
KA/Z 18037 female end	018100005400	Plastic	37.4	A-17.4	19.0	10.5	53.0	5.5	A+13.0
KA/Z 18037 male end	018100005500	Plastic	37.4	A-17.4	19.0	8.5	53.0	5.5	A+13.0
KA/Z 18050 female end	018100005600	Plastic	50.4	A-16.4	19.0	10.5	53.0	5.5	A+13.0
KA/Z 18050 male end	018100005700	Plastic	50.4	A-16.4	19.0	8.5	53.0	5.5	A+13.0
KA/Z 18070 female end	018100005800	Plastic	70.4	A-22.4	19.0	10.5	53.0	5.5	A+13.0
KA/Z 18070 male end	018100005900	Plastic	70.4	A-22.4	19.0	8.5	53.0	5.5	A+13.0



**TR 18.1/2 SEPARATOR**

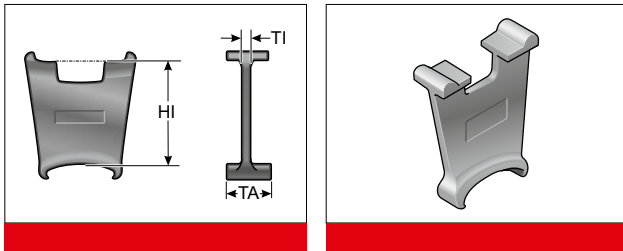

We recommend that separators be used if multiple round cables or conduits with differing diameters are to be installed.

Type	Order No.	Description	TI mm	HI mm
TR 14/18	018200009000	Separator	1.5	18.0

**GUIDE CHANNEL VAW (ALUMINIUM)**



A variable guide channel system, constructed from aluminium sections, is available for this energy chain. The variable guide channel ensures that the energy chain is supported and guided securely.

**ASSEMBLY**

**DISASSEMBLY**

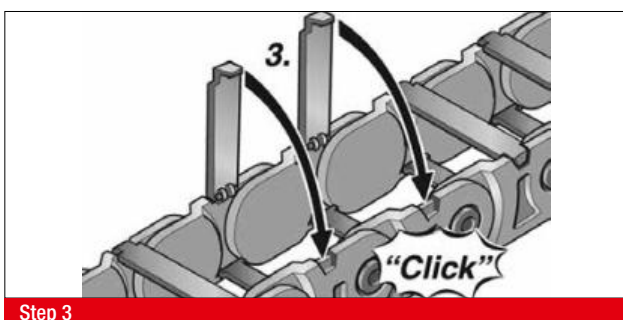
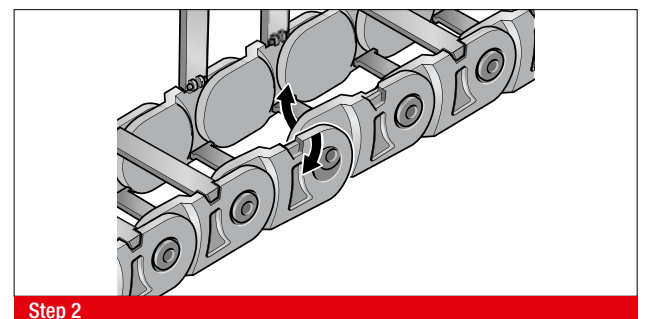
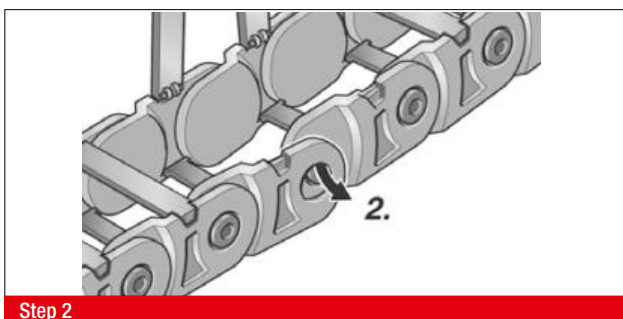
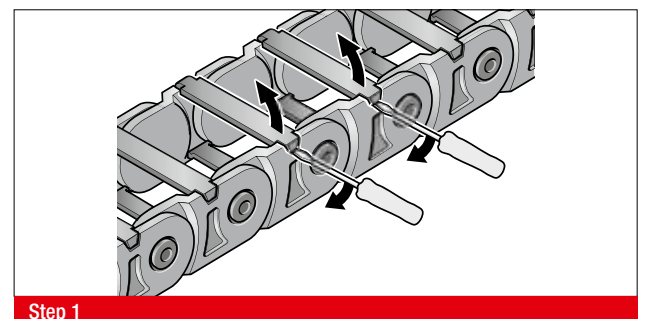
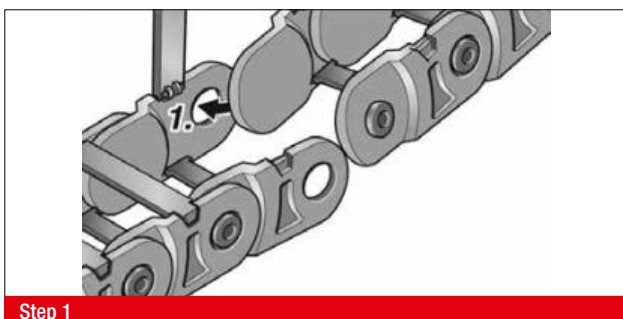

## MP 18.4 OPEN



- HIGH STABILITY
- CHAIN BRACKET WITH INTEGRATED STRAIN RELIEF
- VERY FLEXIBLE, HIGH TORSION
- NON-OPENING

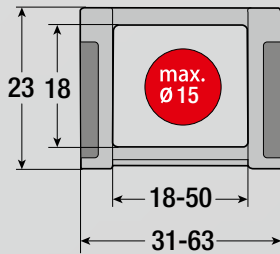

### TECHNICAL DATA

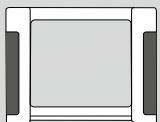

**Loading side**  
Non-opening

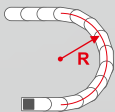

**Available radii**  
40.0 – 80.0 mm

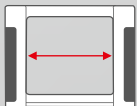

**Available interior widths**  
With plastic crossbar  
18.0 – 50.0 mm

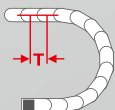

**Pitch**  
T = 33.0 mm



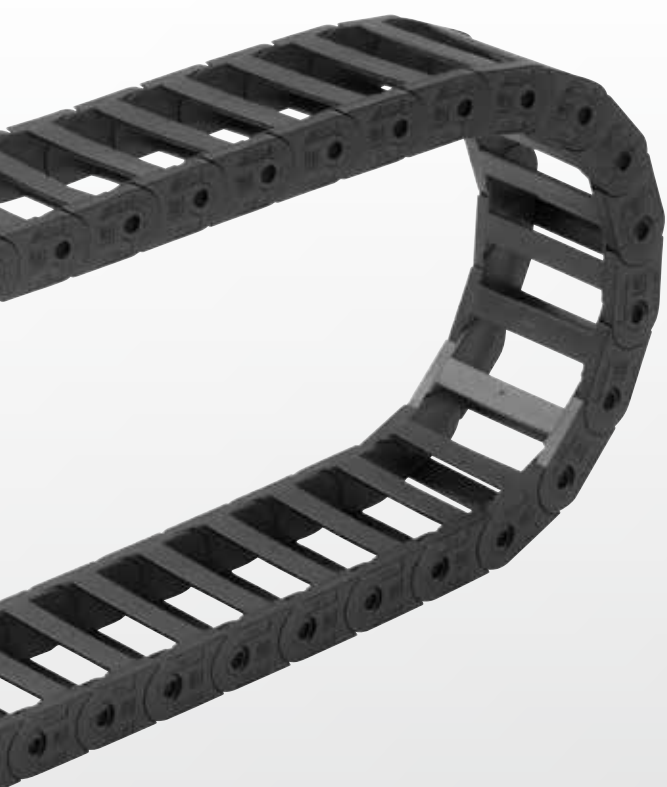

## TECHNICAL SPECIFICATIONS

Travel distance gliding $L_g$ max.	20.0 m
Travel distance self-supporting $L_s$ max.	see diagram on page 89
Travel distance vertical, hanging $L_{vh}$ max.	8.0 m
Travel distance vertical, upright $L_{vs}$ max.	3.0 m
Rotated 90°, unsupported $L_{90f}$ max.	0.5 m
Speed, gliding $V_g$ max.	2.0 m/s
Speed, self-supporting $V_f$ max.	5.0 m/s
Acceleration, gliding $a_g$ max.	5.0 m/s <sup>2</sup>
Acceleration, self-supporting $a_s$ max.	5.0 m/s <sup>2</sup>

Contact our engineering department to meet any higher requirements: [efk@murrplastik.de](mailto:efk@murrplastik.de)

## MATERIAL PROPERTIES

Standard material	Polyamide (PA) black
Service temperature	-30.0 – 120.0 °C
Gliding friction factor	0.3
Static friction factor	0.45
Fire classification	UL 94 HB

Other material properties on request.

### CHAIN BRACKET

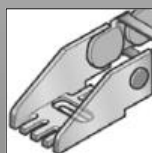

Chain bracket U-part

### SHELVING SYSTEM

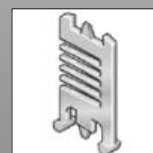

Separator TR

### GUIDE CHANNELS



VAW aluminium

**ORDERING KEY**

Dimensions in mm [US inch]

Type code	Variation	Inside width	Outside width	Inside width	Outside width	Radius	Crossbar variant	Material	Chain length
<b>0184 34</b>	Crossbar on outside bend Crossbar on inside bend Non-opening	<b>018</b> [0.71]	<b>031</b> [1.22]			<b>040<sup>1)</sup></b> [1.57]	<b>0</b> Plastic, full-ridged with bias	<b>0</b> Polyamide standard (PA/black)	
		<b>025</b> [0.98]	<b>038</b> [1.50]						
		<b>037</b> [1.46]	<b>050</b> [1.97]			<b>050<sup>2)</sup></b> [1.97]			
		<b>050</b> [1.97]	<b>063</b> [2.48]						
						<b>080<sup>3)</sup></b> [3.15]			

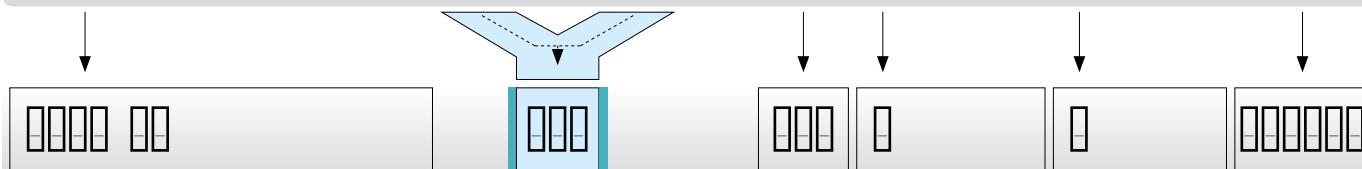

**ORDERING EXAMPLE: 0184 34 025 050 0 0 1020**

Crossbar on outside bend, crossbar on inside bend, cannot be opened  
 Inside width 25 mm; radius 50 mm  
 Plastic crossbar, full-ridged with bias, material black-coloured polyamide  
 Chain length 1020 mm (34 links)

<sup>1)</sup> Only for inside width of 18, 25, 37 mm  
<sup>2)</sup> Only for inside width of 18 mm  
<sup>3)</sup> Only for inside width of 25, 50 mm

**SELF-SUPPORTING LENGTH**

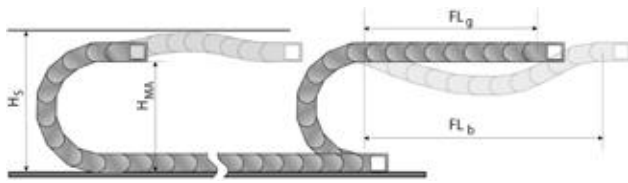

The self-supporting length is the distance between the chain bracket on the moving end and the start of the chain arch.  
 The installation variant  $FL_g$  offers the lowest load and wear for the energy chain.  
 The maximum travel parameters (speed and acceleration) can be applied for this variant.

- $H_s$  = Installation height plus safety
- $H_{MA}$  = Height of moving end connection
- $FL_g$  = Self-supporting length, upper run straight
- $FL_b$  = Self-supporting length, upper run bent

**LOAD DIAGRAM FOR SELF-SUPPORTING APPLICATIONS**

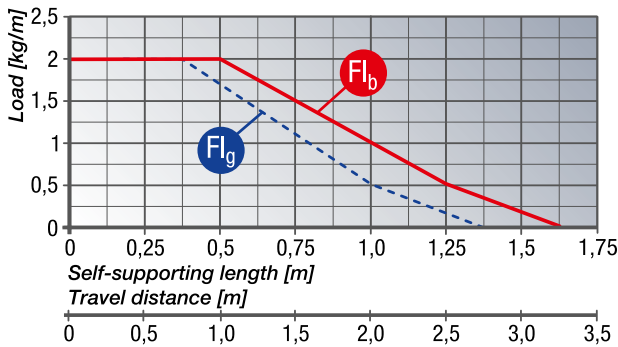

**$FL_g$  Self-supporting length, upper run straight**  
 In the  $FL_g$  range, the chain upper run still has a bias, is straight or has a maximum sag of 40.0 mm.

**$FL_b$  Self-supporting length, upper run bent**  
 In the  $FL_b$  range, the chain upper run has a sag of more than 40.0 mm, but this is still less than the maximum sag. Where the sag is greater than that permitted in the  $FL_b$  range, the application is critical and should be avoided. The self-supporting length can be optimised by using a support for the upper run or a more stable energy chain.

**DETERMINING THE CHAIN LENGTH**

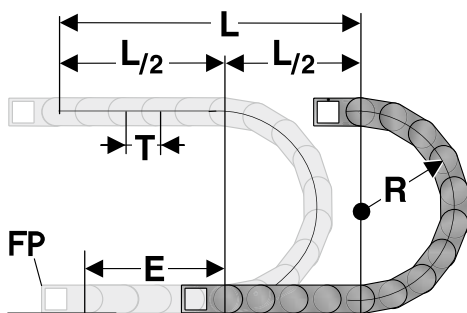

The fixed point of the energy chain should be connected in the middle of the travel distance.  
 This arrangement gives the shortest connection between the fixed point and the moving consumer and thus the most efficient chain length.

Chain length calculation =  $L/2 + \pi * R + 2 * T + E$   
 $\approx 1 \text{ m chain} = 33 \text{ qty. } \times 33.0 \text{ mm.}$

- E = Distance between entry point and middle of travel distance
- L = Travel distance
- R = Radius
- P = Pitch 33.0 mm

**INSTALLATION DIMENSIONS**

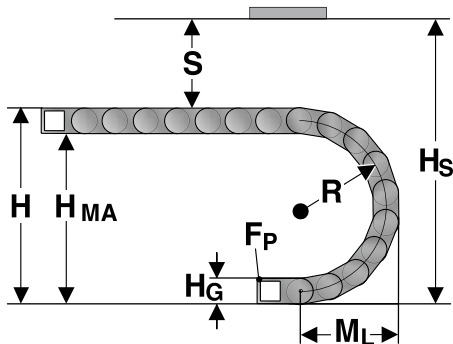

The moving end chain connection is to be screw fixed at height  $H_{MA}$  for the respective radius.  
For the installed dimension the “Installed height  $H_S$ ” value has to be taken into account.

Radius R	40	50	80
Outside height of chain link ( $H_G$ )	23	23	23
Height of bend (H)	103	123	183
Height of moving end bracket ( $H_{MA}$ )	80	100	160
Safety margin (S)	30	30	30
Installation height ( $H_S$ )	133	153	213
Arc projection ( $M_L$ )	85	95	125

**KA 18.4 CHAIN BRACKET U-PART**

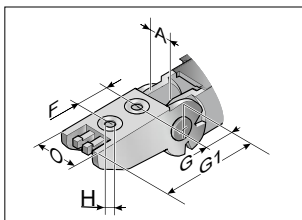

KA/Z 18015 – 025

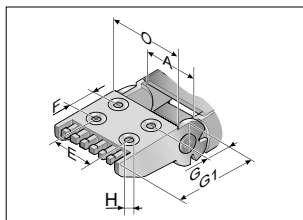

KA/Z 18037 – 070

The chain bracket is an all-plastic part. The bracket is precisely adjusted to the respective chain width and only needs to be snapped in at the chain link. Please order one male and one female end bracket for each chain. The brackets should be fastened with M5 screws. The cables or conduits may be fastened with cable ties on the integrated strain relief of the chain bracket.

Type	Order No.	Material	Inside width						Outside width of KA 0 mm
			A mm	E mm	F mm	G mm	G1 mm	H0 mm	
KA/Z 18.4 018 Hole	018400005000	Plastic	18.0		19.0	23.0	57.0	5.5	A+13.0
KA/Z 18.4 018 Male end	018400005100	Plastic	18.0		19.0	23.0	57.0	5.5	A+13.0
KA/Z 18.4 025 Hole	018400005200	Plastic	25.0		19.0	23.0	57.0	5.5	A+13.0
KA/Z 18.4 025 Male end	018400005300	Plastic	25.0		19.0	25.0	59.0	5.5	A+13.0
KA/Z 18.4 037 Hole	018400005400	Plastic	37.0	A-17.0	19.0	23.0	57.0	5.5	A+13.0
KA/Z 18.4 037 Male end	018400005500	Plastic	37.0	A-17.0	19.0	25.0	59.0	5.5	A+13.0
KA/Z 18.4 050 Hole	018400005600	Plastic	50.0	A-16.0	19.0	23.0	57.0	5.5	A+13.0
KA/Z 18.4 050 Male end	018400005700	Plastic	50.0	A-16.0	19.0	25.0	59.0	5.5	A+13.0

**TR 18.1/2: SEPARATOR**

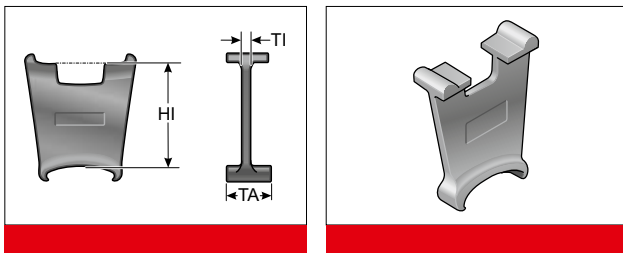

We recommend that separators be used if multiple round cables or conduits with differing diameters are to be installed.

Type	Order No.	Description	TI mm	HI mm
TR 14/18	018200009000	Separator	1.5	18.0

**GUIDE CHANNEL VAW (ALUMINIUM)**



A variable guide channel system, constructed from aluminium sections, is available for this energy chain. The variable guide channel ensures that the energy chain is supported and guided securely.

**ASSEMBLY**

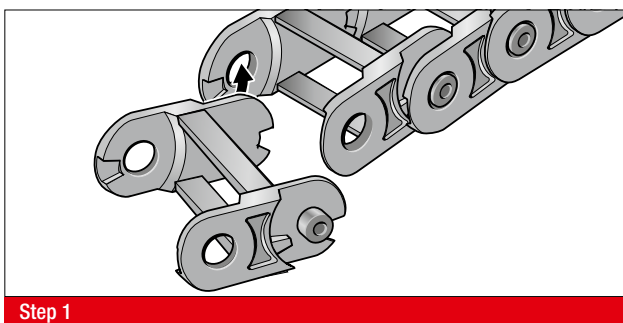

Step 1

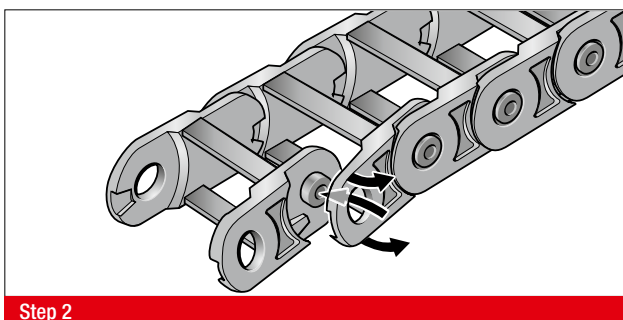

Step 2

**DISASSEMBLY**

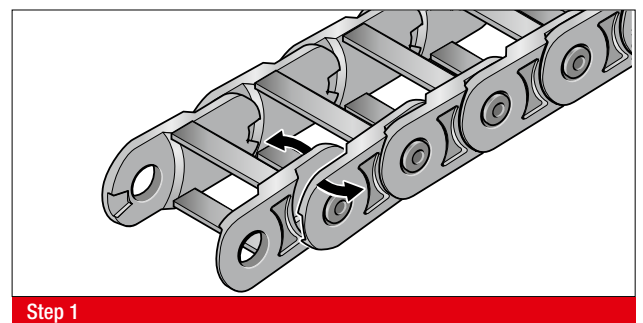

Step 1

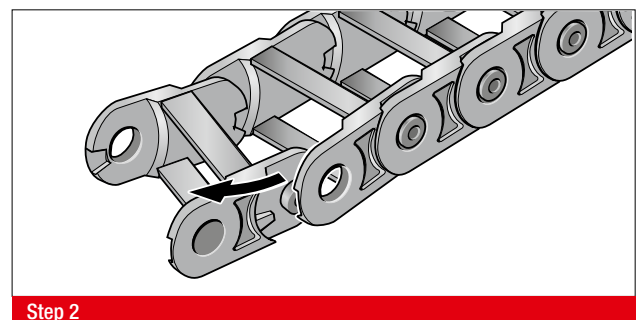

Step 2

## MP 20 OPEN



- LOW-COST VARIANT
- CHAIN BRACKET WITH INTEGRATED STRAIN RELIEF
- CROSSBAR WITH INTEGRAL HINGE

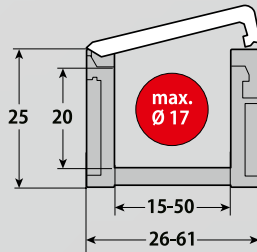

### TECHNICAL DATA

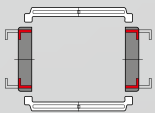

**Loading side**  
Inside bend

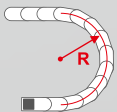

**Available radii**  
38.0 – 125.0 mm

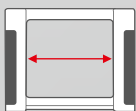

**Available interior widths**  
With plastic crossbar  
15.0 – 50.0 mm

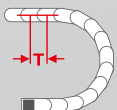

**Pitch**  
T = 35.0 mm





## TECHNICAL SPECIFICATIONS

Travel distance gliding $L_g$ max.	not recommended
Travel distance self-supporting $L_r$ max.	see diagram on page 95
Travel distance vertical, hanging $L_{vh}$ max.	8.0 m
Travel distance vertical, upright $L_{vs}$ max.	3.0 m
Rotated 90°, unsupported $L_{90f}$ max.	0.5 m
Speed, self-supporting $V_f$ max.	10.0 m/s
Acceleration, self-supporting $a$ max.	10.0 m/s <sup>2</sup>

Contact our engineering department to meet any higher requirements: [efk@murrplastik.de](mailto:efk@murrplastik.de)



## MATERIAL PROPERTIES

Standard material	Polyamide (PA) black
Service temperature	-30.0 – 120.0 °C
Gliding friction factor	0.3
Static friction factor	0.45
Fire classification	UL 94 HB

Other material properties on request.

### CHAIN BRACKET

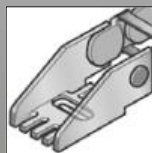

Chain bracket U-part

### SHELVING SYSTEM



Separator TR

### GUIDE CHANNELS



VAW aluminium

# MP 20 OPEN

## ORDERING KEY

Dimensions in mm [US inch]

Type code	Variation	Inside width	Outside width	Inside width	Outside width	Radius	Crossbar variant	Material	Chain length
<b>0202 02</b>	Crossbar on outside bend Crossbar on inside bend Opens on inside bend	<b>015<sup>1)</sup></b> [0.59]	<b>026</b> [1.02]			<b>038</b> [1.50]	<b>0</b> Plastic, full-ridged with bias	<b>0</b> Polyamide standard (PA/black)	
		<b>025</b> [0.98]	<b>036</b> [1.42]						
		<b>038</b> [1.50]	<b>049</b> [1.93]			<b>048</b> [1.89]			
		<b>050</b> [1.97]	<b>061</b> [2.40]			<b>075</b> [2.95]			
						<b>100</b> [3.94]			
						<b>125</b> [4.92]			

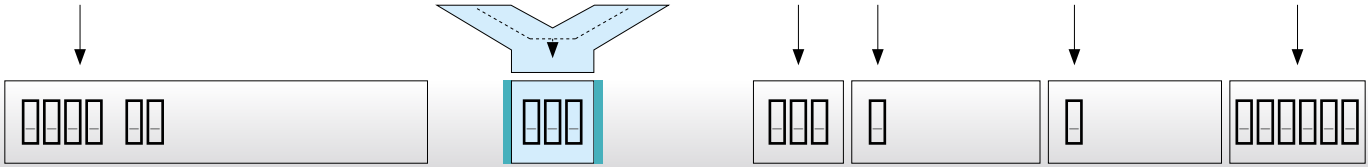

**ORDERING EXAMPLE: 0202 02 025 048 0 0 770**

Crossbar on outside bend, crossbar on inside bend, opens on inside bend  
 Inside width 25 mm; radius 48 mm  
 Plastic crossbar, full-ridged with bias, material black-coloured polyamide  
 Chain length 770 mm (22 links)

<sup>1)</sup> max. line diameter 13 mm

**SELF-SUPPORTING LENGTH**

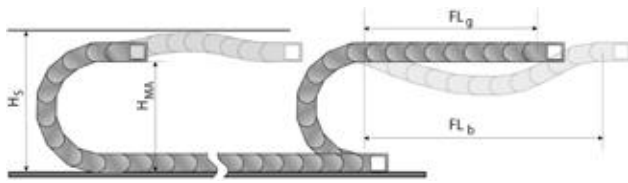

The self-supporting length is the distance between the chain bracket on the moving end and the start of the chain arch.  
 The installation variant  $FL_g$  offers the lowest load and wear for the energy chain.  
 The maximum travel parameters (speed and acceleration) can be applied for this variant.

- $H_S$  = Installation height plus safety
- $H_{MA}$  = Height of moving end connection
- $FL_g$  = Self-supporting length, upper run straight
- $FL_b$  = Self-supporting length, upper run bent

**LOAD DIAGRAM FOR SELF-SUPPORTING APPLICATIONS**

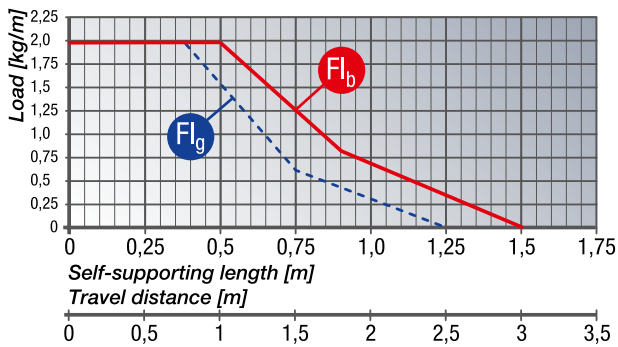

**$FL_g$  Self-supporting length, upper run straight**  
 In the  $FL_g$  range, the chain upper run still has a bias, is straight or has a maximum sag of 40.0 mm.

**$FL_b$  Self-supporting length, upper run bent**  
 In the  $FL_b$  range, the chain upper run has a sag of more than 40.0 mm, but this is still less than the maximum sag. Where the sag is greater than that permitted in the  $FL_b$  range, the application is critical and should be avoided. The self-supporting length can be optimised by using a support for the upper run or a more stable energy chain.

**DETERMINING THE CHAIN LENGTH**

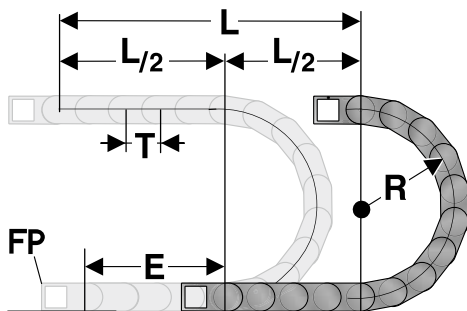

The fixed point of the energy chain should be connected in the middle of the travel distance.  
 This arrangement gives the shortest connection between the fixed point and the moving consumer and thus the most efficient chain length.

Chain length calculation =  $L/2 + \pi * R + 2 * T + E$   
 $\approx 1 \text{ m chain} = 29 \text{ qty. } \times 35.0 \text{ mm.}$

- E = Distance between entry point and middle of travel distance
- L = Travel distance
- R = Radius
- P = Pitch 35.0 mm

**INSTALLATION DIMENSIONS**

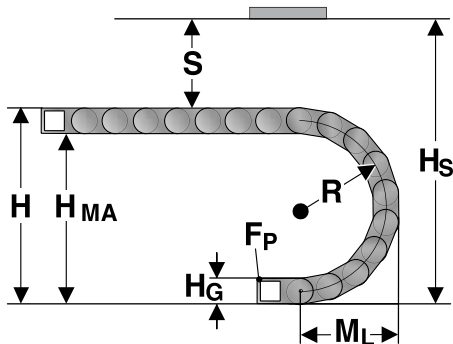

The moving end chain connection is to be screw fixed at height  $H_{MA}$  for the respective radius.  
For the installed dimension the “Installed height  $H_S$ ” value has to be taken into account.

Radius R	38	48	75	100	125
Outside height of chain link ( $H_G$ )	25	25	25	25	25
Height of bend (H)	101	121	175	225	275
Height of moving end bracket ( $H_{MA}$ )	76	96	150	200	250
Safety margin (S)	20	20	20	20	20
Installation height ( $H_S$ )	121	141	195	245	295
Arc projection ( $M_L$ )	86	96	123	148	173

**KA 20 CHAIN BRACKET U-PART**

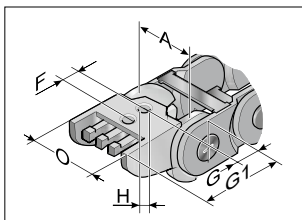

KA 20015 – 20025

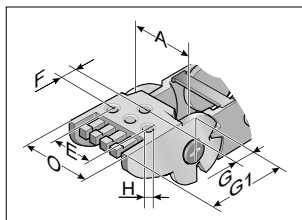

KA 20038 – 20050

The chain bracket is an all-plastic part. The bracket is precisely adjusted to the respective chain width and only needs to be snapped in at the chain link. Please order one male and one female end bracket for each chain. The brackets should be fastened with M5 screws. The cables or conduits may be fastened with cable ties on the integrated strain relief of the chain bracket.

Type	Order No.	Material	Inside width						Outside width of KA 0 mm
			A mm	E mm	F mm	G mm	G1 mm	H0 mm	
KA 20015 Female end	020200005000	Plastic	15.0		19.0	16.5	42.0	5.5	A+11.0
KA 20015 Male end	020200005100	Plastic	15.0		19.0	16.5	42.0	5.5	A+11.0
KA 20025 Female end	020200005200	Plastic	25.0		19.0	16.5	42.0	5.5	A+11.0
KA 20025 Male end	020200005300	Plastic	25.0		19.0	16.5	42.0	5.5	A+11.0
KA 20038 Female end	020200005400	Plastic	38.0	A-18.0	19.0	16.5	42.0	5.5	A+11.0
KA 20038 Male end	020200005500	Plastic	38.0	A-18.0	19.0	16.5	42.0	5.5	A+11.0
KA 20050 Female end	020200005600	Plastic	50.0	A-16.0	19.0	16.5	42.0	5.5	A+11.0
KA 20050 Male end	020200005700	Plastic	50.0	A-16.0	19.0	16.5	42.0	5.5	A+11.0

**TR 20 SEPARATOR**

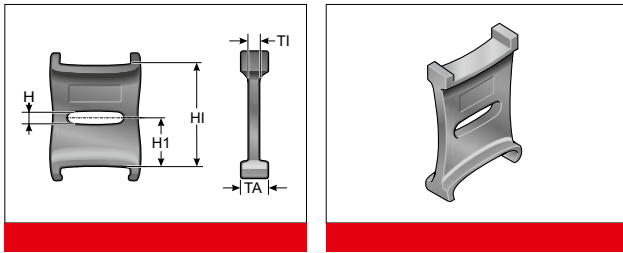

We recommend that separators be used if multiple round cables or conduits with differing diameters are to be installed.

Type	Order No.	Description	Version	TI mm	TA mm	H mm	H1 mm	H2 mm
TR 20	020000009000	Separator	moveable	1.6	8.0	2.5	10.0	10.0

**GUIDE CHANNEL VAW (ALUMINIUM)**



A variable guide channel system, constructed from aluminium sections, is available for this energy chain. The variable guide channel ensures that the energy chain is supported and guided securely.

**ASSEMBLY**

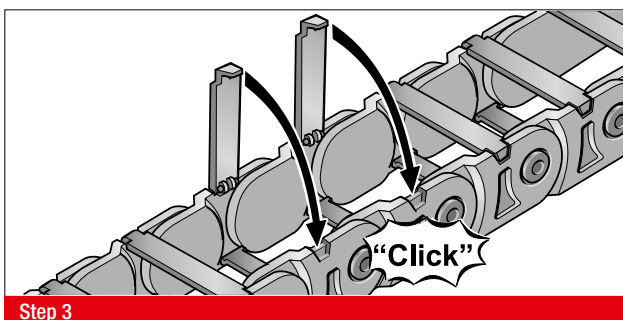
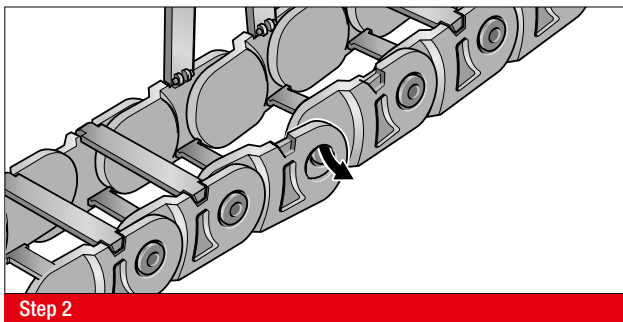

**DISASSEMBLY**

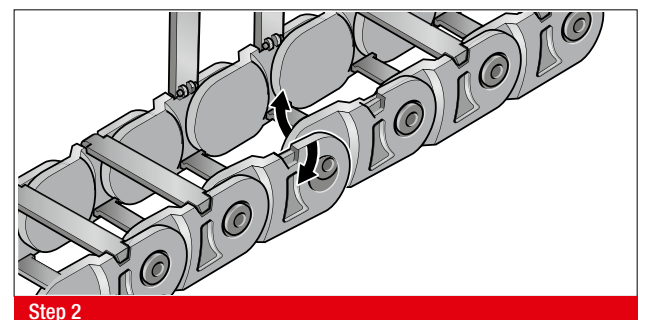
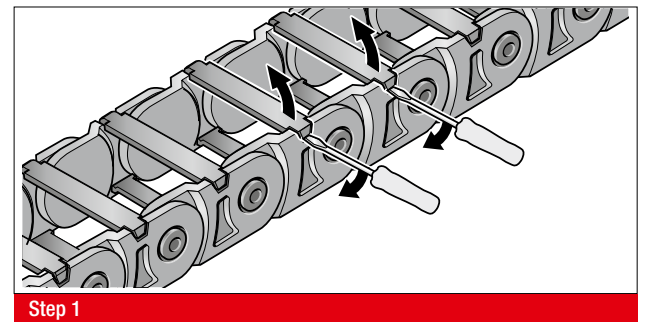

## MP 3000 OPEN



- LOW-COST VARIANT
- CHAIN BRACKET WITH INTEGRATED STRAIN RELIEF

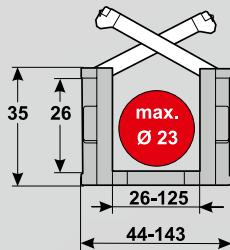

### TECHNICAL DATA

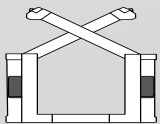

**Loading side**  
Inside bend

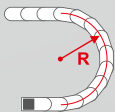

**Available radii**  
50.0 – 300.0 mm

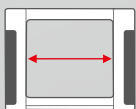

**Available interior widths**  
With plastic crossbar  
26.0 – 125.0 mm

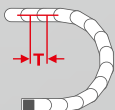

**Pitch**  
T = 45.0 mm

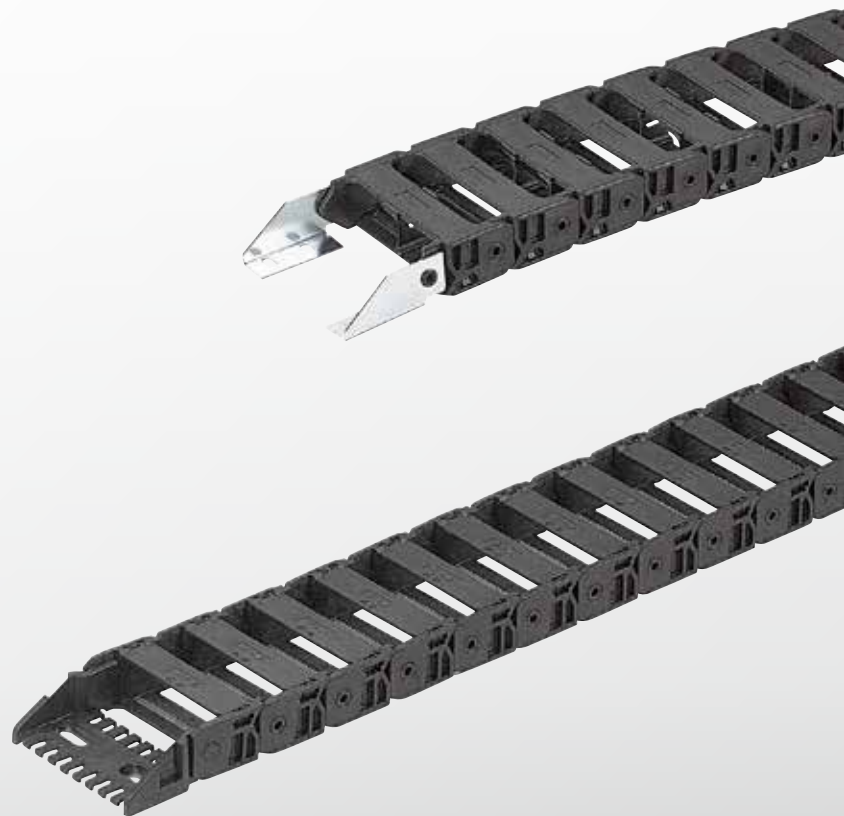

## TECHNICAL SPECIFICATIONS

Travel distance gliding $L_g$ max.	60.0 m
Travel distance self-supporting $L_r$ max.	see diagram on page 101
Travel distance vertical, hanging $L_{vh}$ max.	40.0 m
Travel distance vertical, upright $L_{vs}$ max.	3.0 m
Rotated 90°, unsupported $L_{90r}$ max.	0.7 m
Speed, gliding $V_g$ max.	3.0 m/s
Speed, self-supporting $V_r$ max.	6.0 m/s
Acceleration, gliding $a_g$ max.	10.0 m/s <sup>2</sup>
Acceleration, self-supporting $a_r$ max.	15.0 m/s <sup>2</sup>

Contact our engineering department to meet any higher requirements: [efk@murrplastik.de](mailto:efk@murrplastik.de)



## MATERIAL PROPERTIES

Standard material	Polyamide (PA) black
Service temperature	-30.0 – 120.0 °C
Gliding friction factor	0.3
Static friction factor	0.45
Fire classification	UL 94 HB

Other material properties on request.

## SHELVING SYSTEM

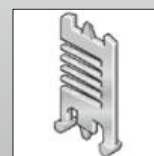

Separator TR

### CHAIN BRACKET

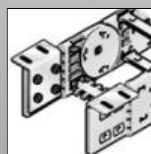

Chain bracket angle



RS shelving system

### GUIDE CHANNELS



VAW steel galvanised / stainless steel

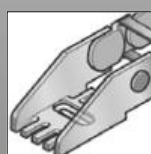

Chain bracket U-part



H-shaped shelf unit RE

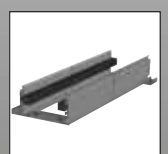

VAW aluminium

**ORDERING KEY**

Dimensions in mm [US inch]

Type code	Variation	Inside width	Outside width	Inside width	Outside width	Radius	Crossbar variant	Material	Chain length
<b>0300 02</b>	Crossbar on outside bend Crossbar on inside bend Opens on inside bend	<b>026</b> [1.02]	<b>044</b> [1.73]			<b>050</b> [1.97]	<b>0</b> Plastic, full-ridged with bias	<b>0</b> Polyamide standard (PA/black)	
		<b>037</b> [1.46]	<b>055</b> [2.17]						
		<b>056</b> [2.20]	<b>074</b> [2.91]						
		<b>062</b> [2.44]	<b>080</b> [3.15]			<b>070</b> [2.76]	<b>1</b> Plastic, full-ridged without bias	<b>1</b> UL94 / V0 (PA/oxide red)	
		<b>076</b> [2.99]	<b>094</b> [3.70]			<b>095</b> [3.74]		<b>5</b> Polypropylene (PP/blue)	
		<b>087</b> [3.43]	<b>105</b> [4.13]						
		<b>101</b> [3.98]	<b>119</b> [4.69]			<b>120</b> [4.72]		<b>7</b> EMC (PA/light grey)	
		<b>125</b> [4.92]	<b>143</b> [5.63]						
						<b>150</b> [5.91]		<b>9</b> Special version (on request)	
						<b>200</b> [7.87]			
						<b>300</b> [11.81]			

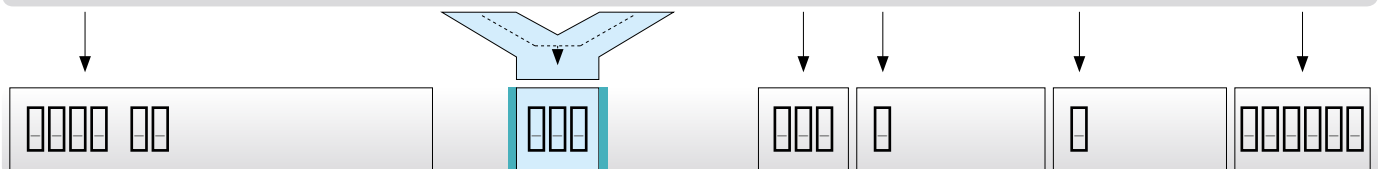

**ORDERING EXAMPLE: 0300 02 026 050 0 0 1215**

Crossbar on outside bend, crossbar on inside bend, can be opened from inside bend  
 Inside width 26 mm; radius 50 mm  
 Plastic crossbar, full-ridged with bias, material black-coloured polyamide  
 Chain length 1215 mm (27 links)



**SELF-SUPPORTING LENGTH**

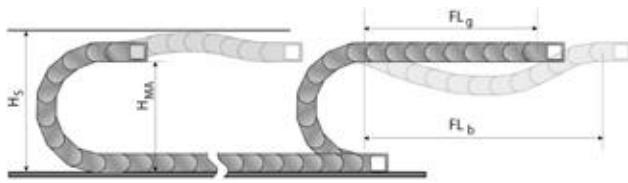

The self-supporting length is the distance between the chain bracket on the moving end and the start of the chain arch. The installation variant  $FL_g$  offers the lowest load and wear for the energy chain. The maximum travel parameters (speed and acceleration) can be applied for this variant.

- $H_s$  = Installation height plus safety
- $H_{MA}$  = Height of moving end connection
- $FL_g$  = Self-supporting length, upper run straight
- $FL_b$  = Self-supporting length, upper run bent

**LOAD DIAGRAM FOR SELF-SUPPORTING APPLICATIONS**

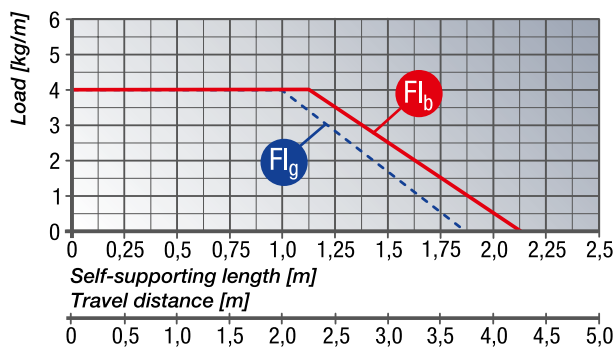

**$FL_g$  Self-supporting length, upper run straight**  
 In the  $FL_g$  range, the chain upper run still has a bias, is straight or has a maximum sag of 60.0 mm.

**$FL_b$  Self-supporting length, upper run bent**  
 In the  $FL_b$  range, the chain upper run has a sag of more than 60.0 mm, but this is still less than the maximum sag. Where the sag is greater than that permitted in the  $FL_b$  range, the application is critical and should be avoided. The self-supporting length can be optimised by using a support for the upper run or a more stable energy chain.

**DETERMINING THE CHAIN LENGTH**

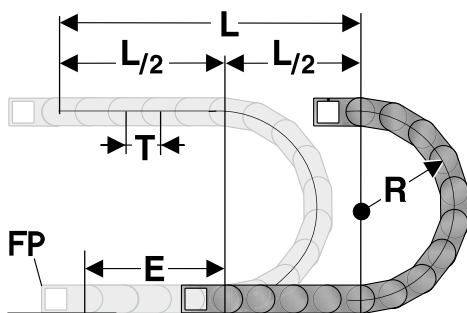

The fixed point of the energy chain should be connected in the middle of the travel distance. This arrangement gives the shortest connection between the fixed point and the moving consumer and thus the most efficient chain length.

Chain length calculation =  $L/2 + \pi * R + 2 * T + E$   
 $\approx 1 \text{ m chain} = 22 \text{ qty. } \times 45.0 \text{ mm.}$

- E = Distance between entry point and middle of travel distance
- L = Travel distance
- R = Radius
- P = Pitch 45.0 mm

**INSTALLATION DIMENSIONS**

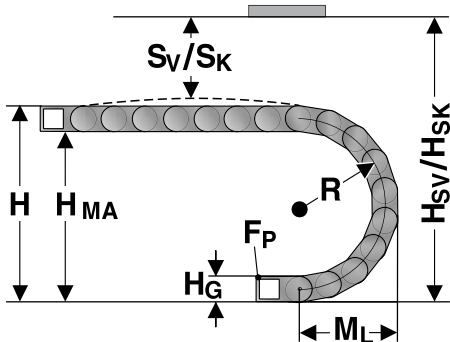

The moving end chain connection is to be screw fixed at height  $H_{MA}$  for the respective radius.

Concerning the installed dimensions, you must take into account whether the chain links are equipped with or without bias.

For chain links without bias, the “Installed height without bias  $H_{SK}$ ” value has to be taken into account.

If the chain links are equipped with a bias, the value “Installed height with bias  $H_{SV}$ ” has to be taken into account.

Radius R	50	70	95	120	150	200	300
Outside height of chain link ( $H_G$ )	35	35	35	35	35	35	35
Height of bend (H)	135	175	225	275	335	435	635
Height of moving end bracket ( $H_{MA}$ )	100	140	190	240	300	400	600
Safety margin with bias ( $S_v$ )	45	45	45	45	45	45	45
Installation height with bias ( $H_{sv}$ )	180	220	270	320	380	480	680
Safety margin without bias ( $S_k$ )	10	10	10	10	10	10	10
Installation height without bias ( $H_{sk}$ )	145	185	235	285	345	445	645
Arc projection ( $M_L$ )	113	133	158	183	213	263	363

**KA 3000 CHAIN BRACKET ANGLE**

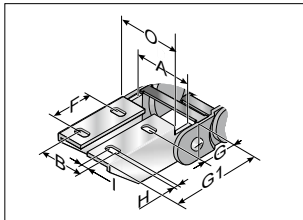

KA 300... (Inside up / down)

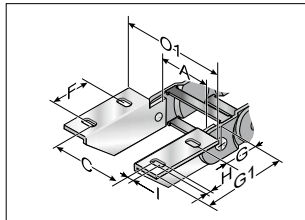

KA 300... (Outside up / down)

The chain bracket can be supplied either in galvanised sheet steel or stainless steel. To secure one cable drag chain, you will need two angle brackets (left and right) with a drilled hole and two angle brackets (left and right) with a bolt. The order numbers given below each comprise a left and right angle bracket.

Type	Order No.	Material	Inside width								Outside width of KA 0	Outside width of KA 01
			A mm	B mm	C mm	F mm	G mm	G1 mm	HØ mm	I mm		
KA 3008 Female end	0300000052	Sheet steel	26.0 – 125.0	A-8.5	A+22.5	25.0	21.0	58.0	6.5	4.5	A+18.0	A+40.0
KA 3008 Male end	0300000053	Sheet steel	26.0 – 125.0	A-3.5	A+31.0	25.0	21.0	57.0	6.5	4.5	A+9.0	A+40.0
KA 3009 Female end	0300000054	Stainless steel 1.4301	26.0 – 125.0	A-8.5	A+22.5	25.0	21.0	58.0	6.5	4.5	A+18.0	A+40.0
KA 3009 Male end	0300000055	Stainless steel 1.4301	26.0 – 125.0	A-3.5	A+31.0	25.0	21.0	57.0	6.5	4.5	A+9.0	A+40.0

**KA 3000 CHAIN BRACKET U-PART**

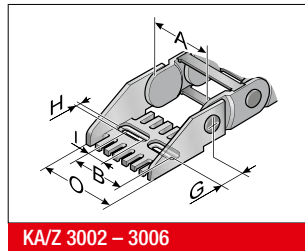
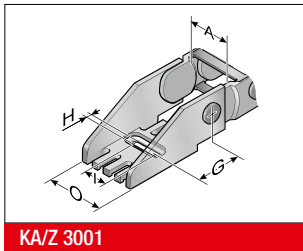

The type KA/Z 3001 – 3006 chain bracket is a plastic part with an extrusion-coated metal insert. The bracket is precisely adjusted to the respective chain width and only needs to be snapped in at the chain link. Please order one male and one female end bracket for each chain. The brackets should be fastened with M6 screws. The cables or tubes may be fastened with cable ties at the integrated strain relief of the chain bracket.

Type	Order No.	Material	Inside width					Outside width of KA O mm
			A mm	B mm	G mm	HØ mm	I mm	
KA/Z 3001 female end	030000008000	Plastic with metal insert	26.0		31.5	6.5	18.5	A+18.0
KA/Z 3001 male end	030000008100	Plastic with metal insert	26.0		31.5	6.5	18.5	A+18.0
KA/Z 3002 female end	030000008200	Plastic with metal insert	37.0	A-7.0	31.5	6.5	7.5	A+18.0
KA/Z 3002 male end	030000008300	Plastic with metal insert	37.0	A-7.0	31.5	6.5	7.5	A+18.0
KA/Z 3002.5 female end	030000007600	Plastic with metal insert	56.0	A-8.0	31.5	6.5	7.5	A+18.0
KA/Z 3002.5 male end	030000007700	Plastic with metal insert	56.0	A-8.0	31.5	6.5	7.5	A+18.0
KA/Z 3003 female end	030000008400	Plastic with metal insert	62.0	A-7.0	31.5	6.5	18.5	A+18.0
KA/Z 3003 male end	030000008500	Plastic with metal insert	62.0	A-7.0	31.5	6.5	18.5	A+18.0
KA/Z 3003.5 female end	030000007800	Plastic with metal insert	76.0	A-8.0	31.5	6.5	18.5	A+18.0
KA/Z 3003.5 male end	030000007900	Plastic with metal insert	76.0	A-8.0	31.5	6.5	18.5	A+18.0
KA/Z 3004 female end	030000008600	Plastic with metal insert	87.0	A-7.0	31.5	6.5	18.5	A+18.0
KA/Z 3004 male end	030000008700	Plastic with metal insert	87.0	A-7.0	31.5	6.5	18.5	A+18.0
KA/Z 3005 female end	030000008800	Plastic with metal insert	101.0	A-7.0	31.5	6.5	18.5	A+18.0
KA/Z 3005 male end	030000008900	Plastic with metal insert	101.0	A-7.0	31.5	6.5	18.5	A+18.0
KA/Z 3006 female end	030000009300	Plastic with metal insert	125.0	A-6.5	31.5	6.5	18.5	A+18.0
KA/Z 3006 male end	030000009400	Plastic with metal insert	125.0	A-6.5	31.5	6.5	18.5	A+18.0

**TR 3000 SEPARATOR**

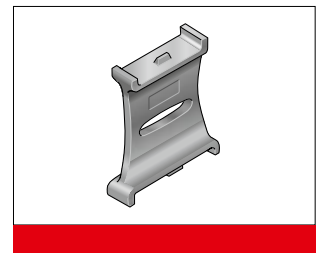
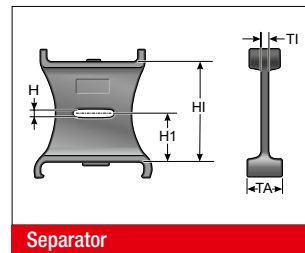
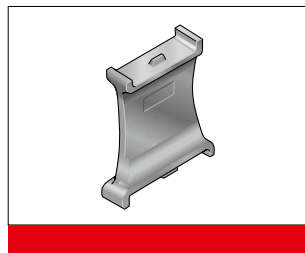
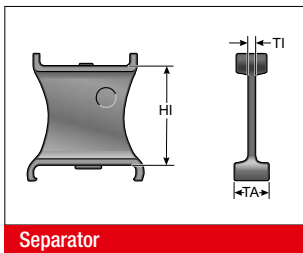

We recommend that separators be used if multiple round cables or conduits with differing diameters are to be installed. For cable

drag chains that need to be side mounted, the lockable (unmovable) separator must be used.

Type	Order No.	Description	Version	TI mm	TA mm	H mm	H1 mm	H2 mm	HI mm
TR 3000	030000009000	Separator	moveable	1.5	13.0	2.5	12.9	12.9	26.0
TR 3001	030000009200	Separator	lockable	1.5	13.0	2.5	12.9	12.9	26.0
TR 3002	030000009500	Separator, closed	lockable	1.5	13.0				26.0

**MP 3000 SHELVING SYSTEM**

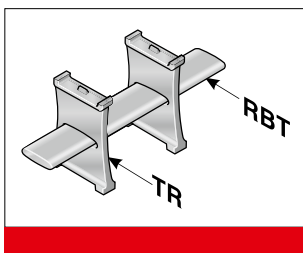

The shelf must be used with a minimum of two separators to create a shelving system. The additional levels prevent cables from criss-crossing and minimise the friction between them. The shelves are matched to the available chain widths.

Type	Order No.	Description	Width mm	Pitch mm
RBT 037	100000003700	Shelf	37.0	3.0
RBT 062	100000006200	Shelf	62.0	3.0
RBT 086	100000008600	Shelf	86.0	3.0
RBT 101	100000010100	Shelf	101.0	3.0
RBT 125	100000012500	Shelf	125.0	3.0

**RE 26 H-SHAPED SHELF UNIT**

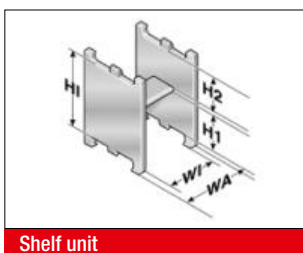

One-piece shelving system, the shelf cannot be varied in height.

Type	Order No.	Description	WA mm	WI mm	H1 mm	H2 mm	HI mm
RE 26/15	100000261510	H-shaped shelf unit	17.5	12.5	13.7	9.6	26.0
RE 26/27	100000262710	H-shaped shelf unit	29.5	24.5	13.7	9.6	26.0
RE 26/32	100000263210	H-shaped shelf unit	34.5	29.5	13.7	9.6	26.0
RE 26/51	100000265110	H-shaped shelf unit	53.5	48.5	13.7	9.6	26.0

**GUIDE CHANNEL VAW (ALUMINIUM / STAINLESS STEEL)**



A range of variable guide channel systems, constructed from aluminium or stainless steel sections, are available for this energy chain.

The variable guide channel ensures that the energy chain is supported and guided securely.

**ASSEMBLY**

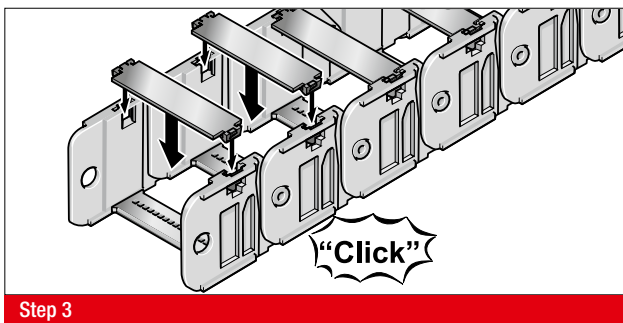
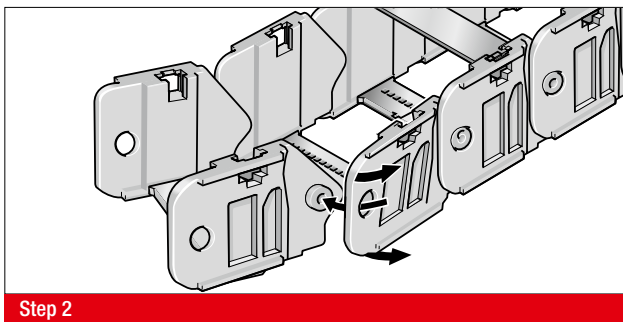
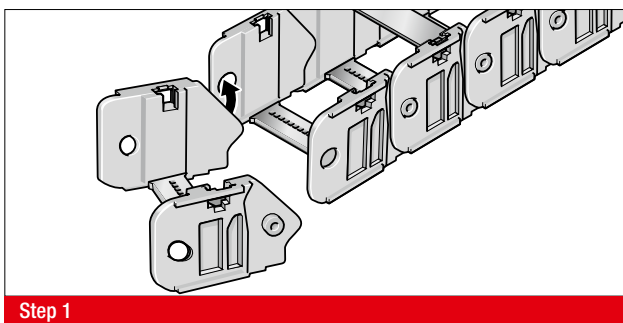

**DISASSEMBLY**

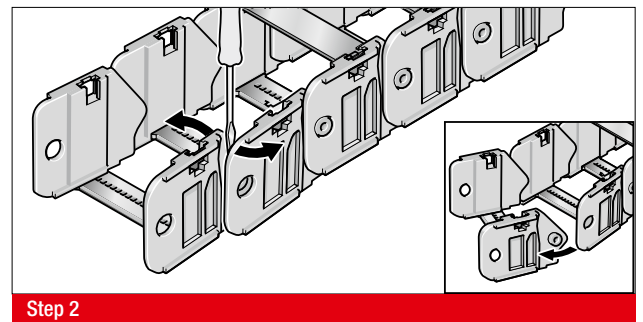
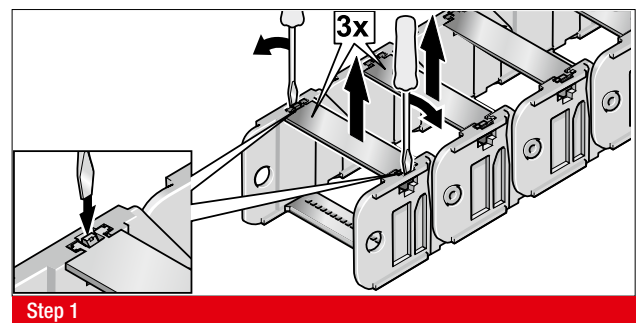

## MP 25G

CLOSED



- CLOSED VARIANTS, STARTING WITH R60
- COMPACT DESIGN

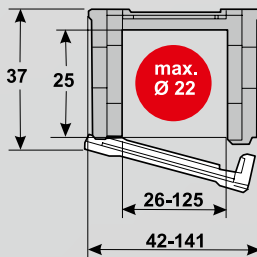

### TECHNICAL DATA

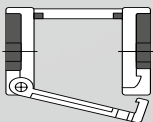

**Loading side**  
Outside bend

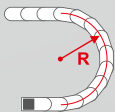

**Available radii**  
60.0 – 250.0 mm

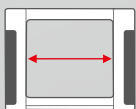

**Available interior widths**  
With plastic crossbar  
26.0 – 125.0 mm

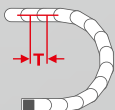

**Pitch**  
T = 30.0 mm

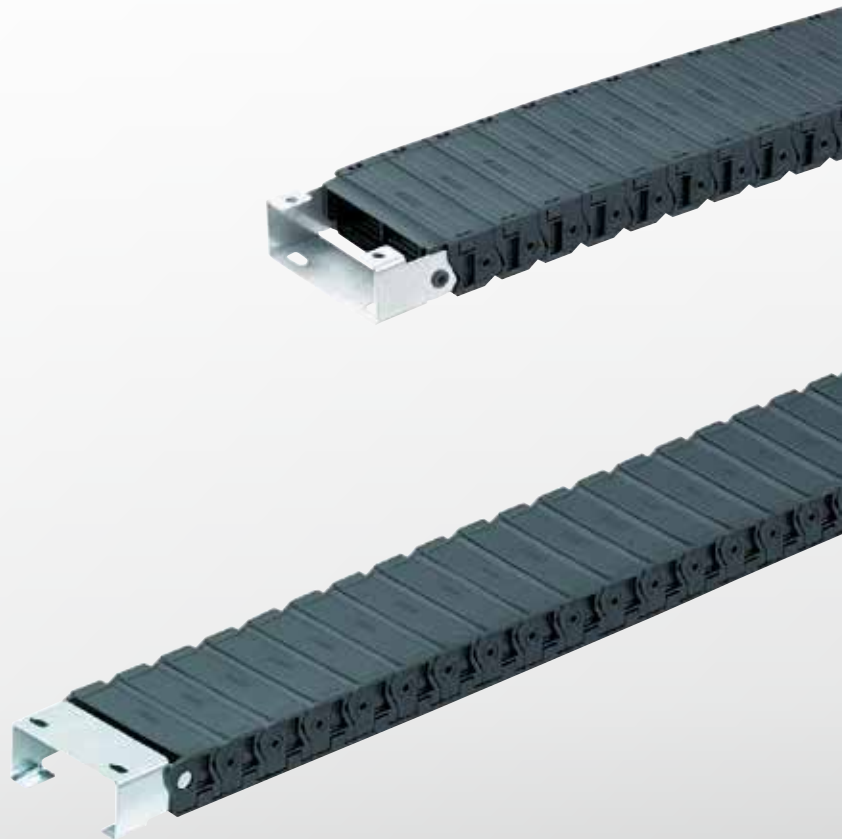

## TECHNICAL SPECIFICATIONS

Travel distance gliding $L_g$ max.	40.0 m
Travel distance self-supporting $L_r$ max.	see diagram on page 109
Travel distance vertical, hanging $L_{vh}$ max.	25.0 m
Travel distance vertical, upright $L_{vs}$ max.	3.0 m
Rotated 90°, unsupported $L_{90f}$ max.	1.0 m
Speed, gliding $V_g$ max.	3.0 m/s
Speed, self-supporting $V_f$ max.	6.0 m/s
Acceleration, gliding $a_g$ max.	10.0 m/s <sup>2</sup>
Acceleration, self-supporting $a_s$ max.	15.0 m/s <sup>2</sup>

Contact our engineering department to meet any higher requirements: [efk@murrplastik.de](mailto:efk@murrplastik.de)



## MATERIAL PROPERTIES

Standard material	Polyamide (PA) black
Service temperature	-30.0 – 120.0 °C
Gliding friction factor	0.3
Static friction factor	0.45
Fire classification	Based on UL 94 HB

Other material properties on request.

### SHELVING SYSTEM

### GUIDE CHANNELS

### CHAIN BRACKET



Separator TR



VAW steel galvanised / stainless steel

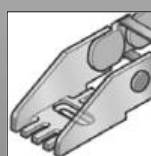

Chain bracket U-part



RS shelving system



VAW aluminium

**ORDERING KEY**

Dimensions in mm [US inch]

Type code	Variation	Inside width	Outside width	Inside width	Outside width	Radius	Crossbar variant	Material	Chain length
<b>0250 03</b>	Cover on outside bend Cover on inside bend Opens on outside bend	<b>026</b> [1.02]	<b>042</b> [1.65]			<b>060</b> [2.36]	<b>0</b> Plastic, full-ridged with bias	<b>0</b> Polyamide standard (PA/black)	
		<b>037</b> [1.46]	<b>053</b> [2.09]						
		<b>062</b> [2.44]	<b>078</b> [3.07]			<b>075</b> [2.95]		<b>7</b> EMC (PA/light grey)	
		<b>087</b> [3.43]	<b>103</b> [4.06]						
		<b>101</b> [3.98]	<b>117</b> [4.61]			<b>100</b> [3.94]		<b>9</b> Special version (on request)	
		<b>125</b> [4.92]	<b>141</b> [5.55]						
						<b>125</b> [4.92]			
						<b>150</b> [5.91]			
						<b>200</b> [7.87]			
						<b>250</b> [9.84]			

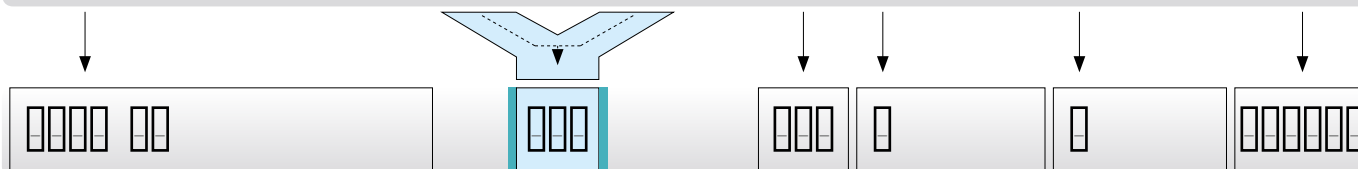

**ORDERING EXAMPLE: 0250 03 026 060 0 0 1230**

Cover on outside bend, cover on inside bend, can be opened from outside bend  
 Inside width 26 mm; radius 60 mm  
 Plastic crossbar, full-ridged with bias, material black-coloured polyamide  
 Chain length 1230 mm (41 links)



**SELF-SUPPORTING LENGTH**

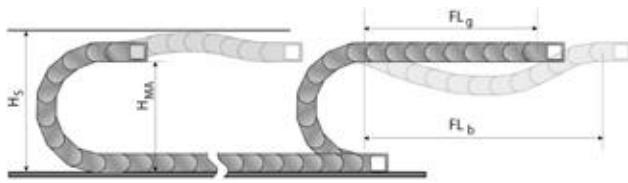

The self-supporting length is the distance between the chain bracket on the moving end and the start of the chain arch. The installation variant  $FL_g$  offers the lowest load and wear for the energy chain. The maximum travel parameters (speed and acceleration) can be applied for this variant.

- $H_s$  = Installation height plus safety
- $H_{MA}$  = Height of moving end connection
- $FL_g$  = Self-supporting length, upper run straight
- $FL_b$  = Self-supporting length, upper run bent

**LOAD DIAGRAM FOR SELF-SUPPORTING APPLICATIONS**

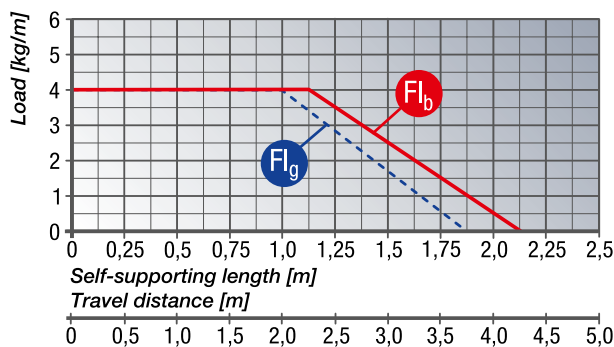

**$FL_g$  Self-supporting length, upper run straight**  
 In the  $FL_g$  range, the chain upper run still has a bias, is straight or has a maximum sag of 60.0 mm.

**$FL_b$  Self-supporting length, upper run bent**  
 In the  $FL_b$  range, the chain upper run has a sag of more than 60.0 mm, but this is still less than the maximum sag. Where the sag is greater than that permitted in the  $FL_b$  range, the application is critical and should be avoided. The self-supporting length can be optimised by using a support for the upper run or a more stable energy chain.

**DETERMINING THE CHAIN LENGTH**

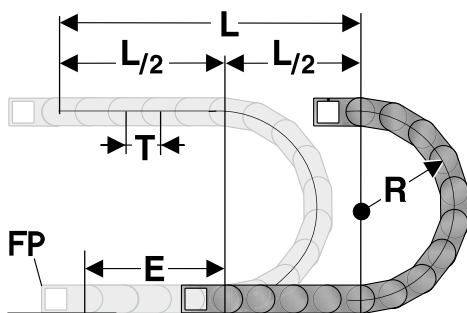

The fixed point of the energy chain should be connected in the middle of the travel distance. This arrangement gives the shortest connection between the fixed point and the moving consumer and thus the most efficient chain length.

Chain length calculation =  $L/2 + \pi * R + 2 * T + E$   
 $\approx 1 \text{ m chain} = 33 \text{ qty. } \times 30.0 \text{ mm.}$

- E = Distance between entry point and middle of travel distance
- L = Travel distance
- R = Radius
- P = Pitch 30.0 mm

**INSTALLATION DIMENSIONS**

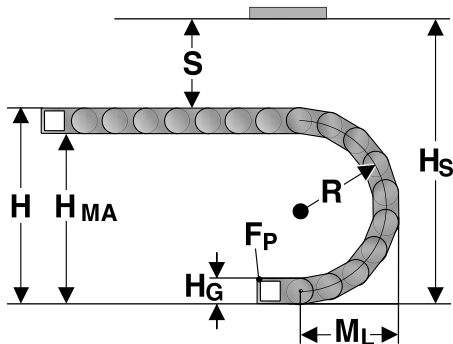

The moving end chain connection is to be screw fixed at height  $H_{MA}$  for the respective radius.  
For the installed dimension the “Installed height  $H_S$ ” value has to be taken into account.

Radius R	60	75	100	125	150	200	250
Outside height of chain link ( $H_G$ )	37	37	37	37	37	37	37
Height of bend (H)	157	187	237	287	337	437	537
Height of moving end bracket ( $H_{MA}$ )	120	150	200	250	300	400	500
Safety margin (S)	33	33	33	33	33	33	33
Installation height ( $H_S$ )	190	220	270	320	370	470	570
Arc projection ( $M_L$ )	109	124	149	174	199	249	299

**KA 25 G CHAIN BRACKET U-PART**

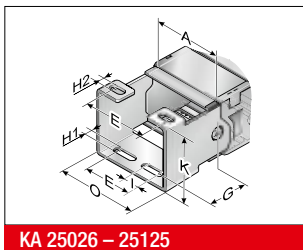

The chain bracket can be supplied either in galvanised sheet steel or stainless steel. To secure one energy chain, you will need a bracket with a drilled hole and a bracket with a bolt.

KA 25026 – 25125

Type	Order No.	Material	Inside width							Outside width of KA 0 mm
			A mm	E mm	G mm	H1 mm	H2 mm	I mm	K mm	
KA 25026 C Female end	025000001000	Sheet steel	26.0	A-10.0	42.0	6.6	6.6	6.6	36.0	A+11.0
KA 25026 C Male end	025000001100	Sheet steel	26.0	A-10.0	42.0	6.6	6.6	6.6	36.0	A+8.0
KA 25037 C Female end	025000001200	Sheet steel	37.0	A-10.0	42.0	6.6	6.6	6.6	36.0	A+11.0
KA 25037 C Male end	025000001300	Sheet steel	37.0	A-10.0	42.0	6.6	6.6	6.6	36.0	A+8.0
KA 25062 C Female end	025000001400	Sheet steel	62.0	A-10.0	42.0	6.6	6.6	6.6	36.0	A+11.0
KA 25062 C Male end	025000001500	Sheet steel	62.0	A-10.0	42.0	6.6	6.6	6.6	36.0	A+8.0
KA 25087 C Female end	025000001600	Sheet steel	87.0	A-10.0	42.0	6.6	6.6	6.6	36.0	A+11.0
KA 25087 C Male end	025000001700	Sheet steel	87.0	A-10.0	42.0	6.6	6.6	6.6	36.0	A+8.0
KA 25101 C Female end	025000001800	Sheet steel	101.0	A-10.0	42.0	6.6	6.6	6.6	36.0	A+11.0
KA 25101 C Male end	025000001900	Sheet steel	101.0	A-10.0	42.0	6.6	6.6	6.6	36.0	A+8.0
KA 25125 C Female end	025000002000	Sheet steel	125.0	A-10.0	42.0	6.6	6.6	6.6	36.0	A+11.0
KA 25125 C Male end	025000002100	Sheet steel	125.0	A-10.0	42.0	6.6	6.6	6.6	36.0	A+8.0
KA 25026 C Female end	025000003000	Stainless steel 1.4301	26.0	A-10.0	42.0	6.6	6.6	6.6	36.0	A+11.0
KA 25026 C Male end	025000003100	Stainless steel 1.4301	26.0	A-10.0	42.0	6.6	6.6	6.6	36.0	A+8.0
KA 25037 C Female end	025000003200	Stainless steel 1.4301	37.0	A-10.0	42.0	6.6	6.6	6.6	36.0	A+11.0

**KA 25 G CHAIN BRACKET U-PART**

Type	Order No.	Material	Inside width								Outside width of KA 0 mm
			A mm	E mm	G mm	H1 mm	H2 mm	I mm	K mm		
KA 25037 C Male end	025000003300	Stainless steel 1.4301	37.0	A-10.0	42.0	6.6	6.6	6.6	36.0	A+8.0	
KA 25062 C Female end	025000003400	Stainless steel 1.4301	62.0	A-10.0	42.0	6.6	6.6	6.6	36.0	A+11.0	
KA 25062 C Male end	025000003500	Stainless steel 1.4301	62.0	A-10.0	42.0	6.6	6.6	6.6	36.0	A+8.0	
KA 25087 C Female end	025000003600	Stainless steel 1.4301	87.0	A-10.0	42.0	6.6	6.6	6.6	36.0	A+11.0	
KA 25087 C Male end	025000003700	Stainless steel 1.4301	87.0	A-10.0	42.0	6.6	6.6	6.6	36.0	A+8.0	
KA 25101 C Female end	025000003800	Stainless steel 1.4301	101.0	A-10.0	42.0	6.6	6.6	6.6	36.0	A+11.0	
KA 25101 C Male end	025000003900	Stainless steel 1.4301	101.0	A-10.0	42.0	6.6	6.6	6.6	36.0	A+8.0	
KA 25125 C Female end	025000004000	Stainless steel 1.4301	125.0	A-10.0	42.0	6.6	6.6	6.6	36.0	A+11.0	
KA 25125 C Male end	025000004100	Stainless steel 1.4301	125.0	A-10.0	42.0	6.6	6.6	6.6	36.0	A+8.0	

**TR 25G SEPARATOR**

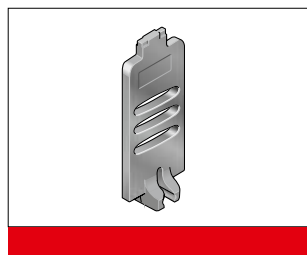
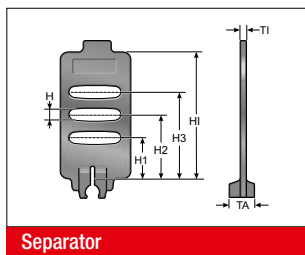

We recommend that separators be used if multiple round cables or conduits with differing diameters are to be installed.

Type	Order No.	Description	Version	TI mm	TA mm	H mm	H1 mm	H2 mm	H3 mm	HI mm
TR 25G	025000009200	Separator	lockable	2.0	8.0	2.5	8.3	12.8	17.3	25.0

**MP 25G SHELVING SYSTEM**



The shelf must be used with a minimum of two separators to create a shelving system. The additional levels prevent cables from criss-crossing and minimise the friction between them. The shelves are matched to the available chain widths.

Type	Order No.	Description	Width mm	Pitch mm
RBT 037	100000003700	Shelf	37.0	2.5
RBT 062	100000006200	Shelf	62.0	2.5
RBT 086	100000008600	Shelf	86.0	2.5
RBT 101	100000010100	Shelf	101.0	2.5
RBT 125	100000012500	Shelf	125.0	2.5

**GUIDE CHANNEL VAW (ALUMINIUM / STAINLESS STEEL)**



A range of variable guide channel systems, constructed from aluminium or stainless steel sections, are available for this energy chain.

The variable guide channel ensures that the energy chain is supported and guided securely.

**ASSEMBLY**

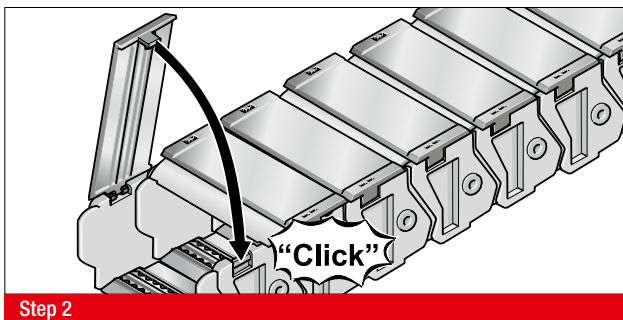
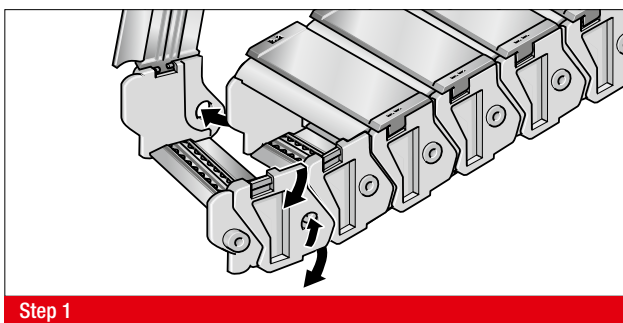

**DISASSEMBLY**

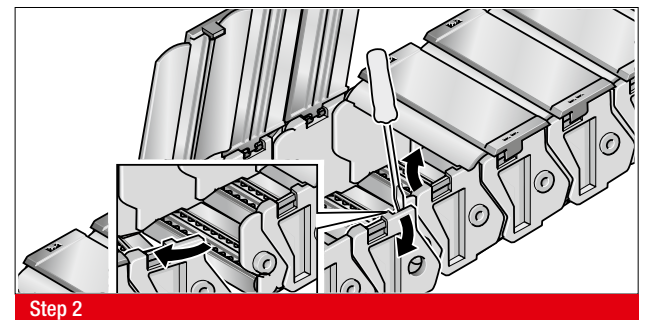
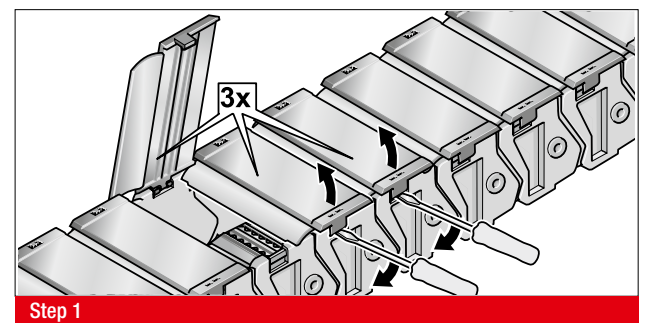



**MP 35.1**  
OPEN



**MP 35.2**  
OPEN



- LOW-COST VARIANT
- SOFT-STOP SYSTEM
- SUITABLE FOR UNIVERSAL USE
- CHAIN BRACKET WITH INTEGRATED STRAIN RELIEF
- EXTENSIVE AND EASY TO INSTALL INTERIOR LAYOUT

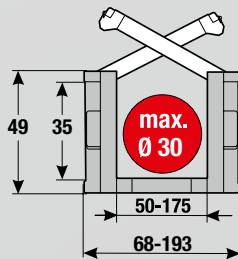

## TECHNICAL DATA

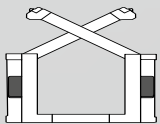

**Loading side**  
Inside or outside bend

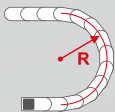

**Available radii**  
63.0 – 250.0

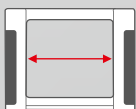

**Available interior widths**  
With plastic crossbar  
50.0 – 175.0

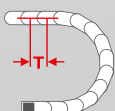

**Pitch**  
T = 56.0 mm



**noise attenuator**



## TECHNICAL SPECIFICATIONS

Travel distance gliding $L_g$ max.	80.0 m
Travel distance self-supporting $L_s$ max.	see diagram on page 117
Travel distance vertical, hanging $L_{vh}$ max.	50.0 m
Travel distance vertical, upright $L_{vs}$ max.	3.0 m
Rotated 90°, unsupported $L_{90f}$ max.	1.0 m
Speed, gliding $V_g$ max.	5.0 m/s
Speed, self-supporting $V_s$ max.	20.0 m/s
Acceleration, gliding $a_g$ max.	15.0 m/s <sup>2</sup>
Acceleration, self-supporting $a_s$ max.	50.0 m/s <sup>2</sup>

Contact our engineering department to meet any higher requirements: [efk@murrplastik.de](mailto:efk@murrplastik.de)



## MATERIAL PROPERTIES

Standard material	Polyamide (PA) black
Service temperature	-30.0 – 120.0 °C
Gliding friction factor	0.3
Static friction factor	0.45
Fire classification	UL 94 HB

Other material properties on request.

### CHAIN BRACKET

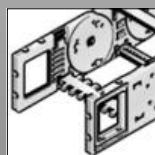

Chain bracket flexible

### SHELVING SYSTEM



Separator TR

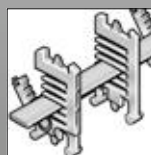

RS shelving system

### GUIDE CHANNELS



VAW steel galvanised / stainless steel

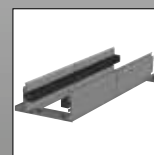

VAW aluminium

### STRAIN RELIEF

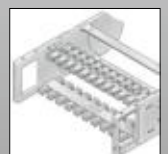

RS-ZL crossbar strain relief



STF Steel Fix

**ORDERING KEY**

Dimensions in mm [US inch]

Type code	Variation	Inside width	Outside width	Inside width	Outside width	Radius	Crossbar variant	Material	Chain length																																																																																																								
0351 01	MP 35.1 open Crossbar on outside bend Crossbar on inside bend Opens on outside bend	050 [1.97]	068 [2.68]			063 [2.48]	0 Plastic, full-ridged with bias	2 Polyamide without attenuator (PA/black)																																																																																																									
		065 <sup>1)</sup> [2.56]	083 <sup>1)</sup> [3.27]							0352 02	MP 35.2 open Crossbar on outside bend Crossbar on inside bend Opens on inside bend	075 [2.95]	093 [3.66]			075 [2.95]	1 Plastic, full-ridged without bias	3 Polyamide with attenuator (PA/black)		090 <sup>1)</sup> [3.54]	108 <sup>1)</sup> [4.25]					100 [3.94]	118 [4.65]			100 [3.94]		9 Special version (on request)				125 [4.92]	143 [5.63]					150 [5.91]	168 [6.61]			125 [4.92]						175 [6.89]	193 [7.60]									150 [5.91]																175 [6.89]																200 [7.87]																250 [9.84]			
0352 02	MP 35.2 open Crossbar on outside bend Crossbar on inside bend Opens on inside bend	075 [2.95]	093 [3.66]			075 [2.95]	1 Plastic, full-ridged without bias	3 Polyamide with attenuator (PA/black)																																																																																																									
		090 <sup>1)</sup> [3.54]	108 <sup>1)</sup> [4.25]									100 [3.94]	118 [4.65]			100 [3.94]		9 Special version (on request)				125 [4.92]	143 [5.63]					150 [5.91]	168 [6.61]			125 [4.92]						175 [6.89]	193 [7.60]									150 [5.91]																175 [6.89]																200 [7.87]																250 [9.84]																	
		100 [3.94]	118 [4.65]			100 [3.94]		9 Special version (on request)																																																																																																									
		125 [4.92]	143 [5.63]									150 [5.91]	168 [6.61]			125 [4.92]						175 [6.89]	193 [7.60]									150 [5.91]																175 [6.89]																200 [7.87]																250 [9.84]																																	
		150 [5.91]	168 [6.61]			125 [4.92]																																																																																																											
		175 [6.89]	193 [7.60]													150 [5.91]																175 [6.89]																200 [7.87]																250 [9.84]																																																	
						150 [5.91]																																																																																																											
																175 [6.89]																200 [7.87]																250 [9.84]																																																																	
						175 [6.89]																																																																																																											
																200 [7.87]																250 [9.84]																																																																																	
						200 [7.87]																																																																																																											
																250 [9.84]																																																																																																	
						250 [9.84]																																																																																																											



Ordering example: 0352 02 075 100 0 3 2016  
 Crossbar on outside bend, crossbar on inside bend, can be opened from inside bend  
 Internal width 075 mm, Radius 100mm  
 Plastic, full-ridged with bias, material polyamide with damper (PA/black)  
 Chain length 2016 mm (36 links)

<sup>1)</sup> Available from Q 4/2018



**SELF-SUPPORTING LENGTH**

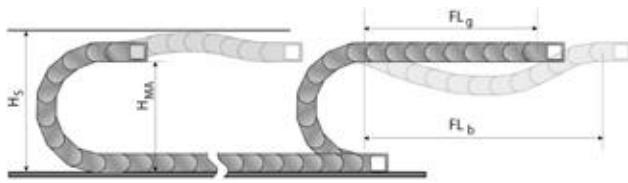

The self-supporting length is the distance between the chain bracket on the moving end and the start of the chain arch.  
 The installation variant  $FL_g$  offers the lowest load and wear for the energy chain.  
 The maximum travel parameters (speed and acceleration) can be applied for this variant.

- $H_s$  = Installation height plus safety
- $H_{MA}$  = Height of moving end connection
- $FL_g$  = Self-supporting length, upper run straight
- $FL_b$  = Self-supporting length, upper run bent

**LOAD DIAGRAM FOR SELF-SUPPORTING APPLICATIONS**

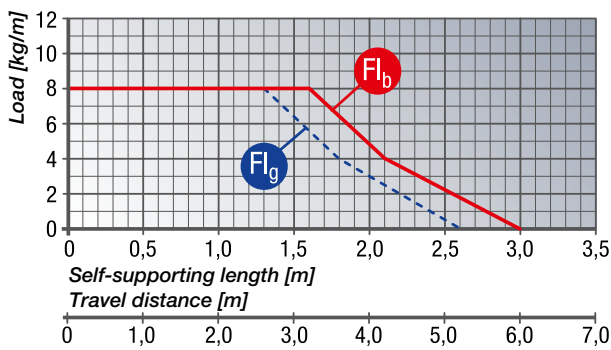

**$FL_g$  Self-supporting length, upper run straight**  
 In the  $FL_g$  range, the chain upper run still has a bias, is straight or has a maximum sag of 60.0 mm.

**$FL_b$  Self-supporting length, upper run bent**  
 In the  $FL_b$  range, the chain upper run has a sag of more than 60.0 mm, but this is still less than the maximum sag. Where the sag is greater than that permitted in the  $FL_b$  range, the application is critical and should be avoided. The self-supporting length can be optimised by using a support for the upper run or a more stable energy chain.

**DETERMINING THE CHAIN LENGTH**

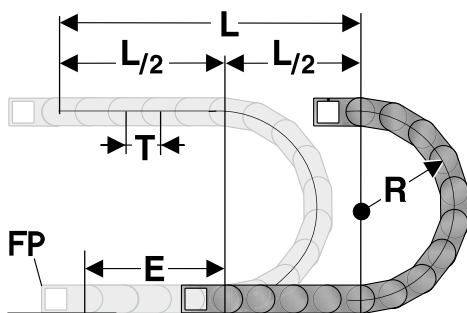

The fixed point of the energy chain should be connected in the middle of the travel distance.  
 This arrangement gives the shortest connection between the fixed point (FP) and the moving consumer and thus the most efficient chain length.

Chain length calculation =  $L/2 + \pi * R + E$   
 $\approx 1 \text{ m chain} = 18 \text{ qty. } \times 56.0 \text{ mm.}$

- E = Distance between entry point and middle of travel distance
- L = Travel distance
- R = Radius
- P = Pitch 56.0 mm

**INSTALLATION DIMENSIONS**

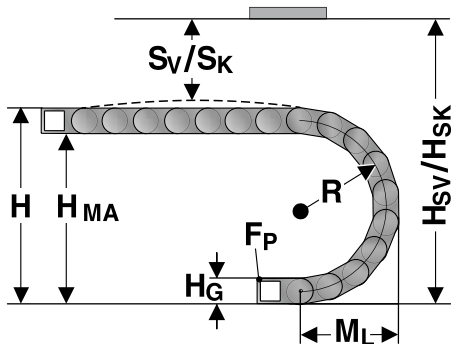

The moving end chain connection is to be screw fixed at height  $H_{MA}$  for the respective radius.

Concerning the installed dimensions, you must take into account whether the chain links are equipped with or without bias.

For chain links without bias, the “Installed height without bias  $H_{SK}$ ” value has to be taken into account.

If the chain links are equipped with a bias, the value “Installed height with bias  $H_{SV}$ ” has to be taken into account.

Radius R	63	75	100	125	150	175	200	250
Outside height of chain link ( $H_G$ )	49	49	49	49	49	49	49	49
Height of bend (H)	175	199	249	299	349	399	449	549
Height of moving end bracket ( $H_{MA}$ )	126	150	200	250	300	350	400	500
Safety margin with bias ( $S_V$ )	20	20	20	20	20	20	20	20
Installation height with bias ( $H_{SV}$ ) without damper	245	269	319	369	419	469	519	619
Installation height with bias ( $H_{SV}$ ) with damper	265	289	339	389	439	489	539	639
Safety margin without bias ( $S_K$ )	20	20	20	20	20	20	20	20
Installation height without bias ( $H_{SK}$ ) without damper	195	219	269	319	369	419	469	569
Installation height without bias ( $H_{SK}$ ) with damper	215	239	289	339	389	439	489	589
Arc projection ( $M_L$ )	144	156	181	206	231	256	281	331

**DAMPING ELEMENT FOR THE CHAIN LINKS**

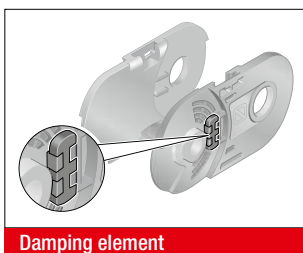

Damping element

The damping elements in the stops facilitate a significantly quieter unrolling of the chain links. The dampers can be chosen optionally.

A reduction of the noise emission by up to 10 dB(A) comparing to the variants without the use of damping elements is possible.

**KA 35 CHAIN BRACKET FLEXIBLE**

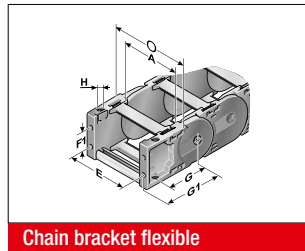
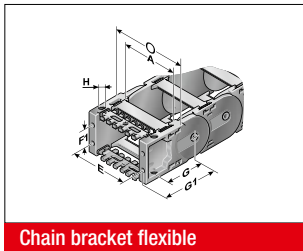

This chain bracket offers universal connection options (top, bottom and front) and is attached to the ends of the energy chain like a side link. This allows the chain to move right up to the bracket. Each energy chain requires one male and one female bracket. M5 screws are used to secure the brackets in place. Press-in metal bushes with a through-hole ensure the permanent, high-strength transmission of even extreme forces onto the energy chain.

By default, the chain bracket is supplied with frame bridges. The chain bracket can then be optionally fitted with frame bridge strain relief plates (RS-ZL) or with strain relief using C-rails and type STF bow clamps.

Type	Order No.	Material	Inside width							Outside width	
			A mm	E mm	F1 mm	G mm	G1 mm	H mm	H0 mm	of KA 0 mm	
KA 35-FB Female end, 050, complete	0350005050	Plastic	50.0	A+8.0	19.0	49.1	77.6	M5	5.5	A+19.0	
KA 35-FB Female end, 050, pendular, complete	0350005052	Plastic	50.0	A+8.0	19.0	49.1	77.6	M5	5.5	A+19.0	
KA 35-FB Male end, 050, complete	0350005051	Plastic	50.0	A+8.0	19.0	49.1	77.6	M5	5.5	A+19.0	
KA 35-FB Male end, 050, pendular, complete	0350005053	Plastic	50.0	A+8.0	19.0	49.1	77.6	M5	5.5	A+19.0	
KA 35-FB Female end, 065, complete	0350006550	Plastic	65.0	A+8.0	19.0	49.1	77.6	M5	5.5	A+19.0	
KA 35-FB Female end, 065, pendular, complete	0350006552	Plastic	65.0	A+8.0	19.0	49.1	77.6	M5	5.5	A+19.0	
KA 35-FB Male end, 065, complete	0350006551	Plastic	65.0	A+8.0	19.0	49.1	77.6	M5	5.5	A+19.0	
KA 35-FB Male end, 065, pendular, complete	0350006553	Plastic	65.0	A+8.0	19.0	49.1	77.6	M5	5.5	A+19.0	
KA 35-FB Female end, 075, complete	0350007550	Plastic	75.0	A+8.0	19.0	49.1	77.6	M5	5.5	A+19.0	
KA 35-FB Female end, 075, pendular, complete	0350007552	Plastic	75.0	A+8.0	19.0	49.1	77.6	M5	5.5	A+19.0	
KA 35-FB Male end, 075, complete	0350007551	Plastic	75.0	A+8.0	19.0	49.1	77.6	M5	5.5	A+19.0	
KA 35-FB Male end, 075, pendular, complete	0350007553	Plastic	75.0	A+8.0	19.0	49.1	77.6	M5	5.5	A+19.0	
KA 35-FB Female end, 090, complete	0350009050	Plastic	90.0	A+8.0	19.0	49.1	77.6	M5	5.5	A+19.0	
KA 35-FB Female end, 090, pendular, complete	0350009052	Plastic	90.0	A+8.0	19.0	49.1	77.6	M5	5.5	A+19.0	
KA 35-FB Male end, 090, complete	0350009051	Plastic	90.0	A+8.0	19.0	49.1	77.6	M5	5.5	A+19.0	
KA 35-FB Male end, 090, pendular, complete	0350009053	Plastic	90.0	A+8.0	19.0	49.1	77.6	M5	5.5	A+19.0	
KA 35-FB Female end, 100, complete	0350010050	Plastic	100.0	A+8.0	19.0	49.1	77.6	M5	5.5	A+19.0	
KA 35-FB Female end, 100, pendular, complete	0350010052	Plastic	100.0	A+8.0	19.0	49.1	77.6	M5	5.5	A+19.0	
KA 35-FB Male end, 100, complete	0350010051	Plastic	100.0	A+8.0	19.0	49.1	77.6	M5	5.5	A+19.0	
KA 35-FB Male end, 100, pendular, complete	0350010053	Plastic	100.0	A+8.0	19.0	49.1	77.6	M5	5.5	A+19.0	
KA 35-FB Female end, 125, complete	0350012550	Plastic	125.0	A+8.0	19.0	49.1	77.6	M5	5.5	A+19.0	
KA 35-FB Female end, 125, pendular, complete	0350012552	Plastic	125.0	A+8.0	19.0	49.1	77.6	M5	5.5	A+19.0	
KA 35-FB Male end, 125, complete	0350012551	Plastic	125.0	A+8.0	19.0	49.1	77.6	M5	5.5	A+19.0	
KA 35-FB Male end, 125, pendular, complete	0350012553	Plastic	125.0	A+8.0	19.0	49.1	77.6	M5	5.5	A+19.0	
KA 35-FB Female end, 150, complete	0350015050	Plastic	150.0	A+8.0	19.0	49.1	77.6	M5	5.5	A+19.0	
KA 35-FB Female end, 150, pendular, complete	0350015052	Plastic	150.0	A+8.0	19.0	49.1	77.6	M5	5.5	A+19.0	
KA 35-FB Male end, 150, complete	0350015051	Plastic	150.0	A+8.0	19.0	49.1	77.6	M5	5.5	A+19.0	
KA 35-FB Male end, 150, pendular, complete	0350015053	Plastic	150.0	A+8.0	19.0	49.1	77.6	M5	5.5	A+19.0	
KA 35-FB Female end, 175, complete	0350017550	Plastic	175.0	A+8.0	19.0	49.1	77.6	M5	5.5	A+19.0	
KA 35-FB Female end, 175, pendular, complete	0350017552	Plastic	175.0	A+8.0	19.0	49.1	77.6	M5	5.5	A+19.0	
KA 35-FB Male end, 175, complete	0350017551	Plastic	175.0	A+8.0	19.0	49.1	77.6	M5	5.5	A+19.0	
KA 35-FB Male end, 175, pendular, complete	0350017553	Plastic	175.0	A+8.0	19.0	49.1	77.6	M5	5.5	A+19.0	

**TRT 35 DIVISIBLE SEPARATOR**

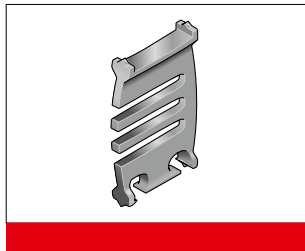
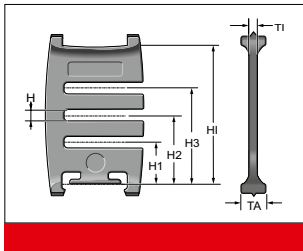

We recommend that separators be used if multiple round cables or conduits with differing diameters are to be installed.

Type	Order No.	Description	Version	TI mm	TA mm	H mm	H1 mm	H2 mm	H3 mm	Hl mm
TRT 35	035000009400	TRT 35, separator, divisible	lockable	3.0	8.0	3.2	10.5	17.5	24.5	35.0

**TR 35-V SEPARATOR**

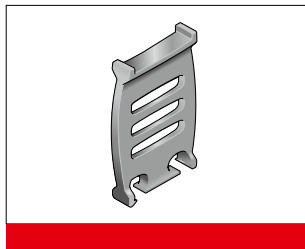
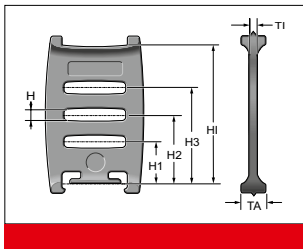

We recommend that separators be used if multiple round cables or conduits with differing diameters are to be installed.

Type	Order No.	Description	Version	TI mm	TA mm	H mm	H1 mm	H2 mm	H3 mm	Hl mm
TR 35-V	035000009300	TR 35-V Separator	moveable	3.0	8.0	3.2	10.5	17.5	24.5	35.0

**RTT 35 SHELF SUPPORT, DIVISIBLE**

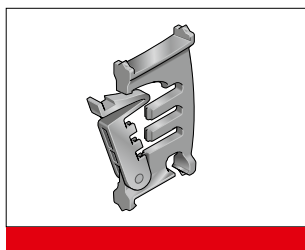
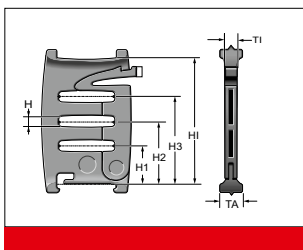

In connection with two separable shelf supports (RTT) with at least one end-to-end shelf (RB) the shelf becomes an easy to fill shelving system. The additional levels prevent cables from criss-crossing and minimise the friction between them.

Type	Order No.	Description	Version	TI mm	TA mm	H mm	H1 mm	H2 mm	H3 mm	Hl mm
RTT 35	100090350000	Shelf support, divisible	lockable	5.0	8.0	3.2	10.5	17.5	24.5	35.0

**RB-3 SHELF**

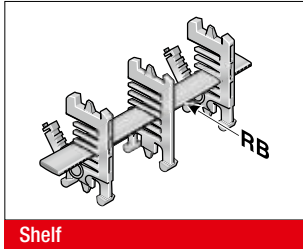

In connection with at least two separable shelf supports (RTT), the shelf becomes a shelving system. The additional levels prevent cables from criss-crossing and minimise the friction between them.

Type	Order No.	Description	Width mm	Inside width mm
RB 039-3	030100003900	Shelf	38.6	40.0
RB 041-3	1000004103	Shelf	41.1	50.0
RB 044-3	1000004403	Shelf	43.6	50.0
RB 046-3	1000004603	Shelf	46.1	50.0
RB 049-3	030100004900	Shelf	48.6	50.0
RB 051-3	1000005103	Shelf	51.1	60.0
RB 054-3	1000005403	Shelf	53.6	60.0
RB 056-3	1000005603	Shelf	56.1	60.0
RB 059-3	030100005900	Shelf	58.6	60.0
RB 061-3	1000006103	Shelf	61.1	75.0
RB 064-3	1000006403	Shelf	63.6	75.0
RB 066-3	1000006603	Shelf	66.1	75.0
RB 069-3	1000006903	Shelf	68.6	75.0
RB 071-3	1000007103	Shelf	71.1	75.0
RB 074-3	030100007400	Shelf	73.6	75.0
RB 076-3	1000007603	Shelf	76.1	85.0
RB 079-3	1000007903	Shelf	78.6	85.0
RB 081-3	1000008103	Shelf	81.1	85.0
RB 084-3	030100008400	Shelf	83.6	85.0
RB 086-3	1000008603	Shelf	86.1	100.0
RB 089-3	1000008903	Shelf	88.6	100.0
RB 091-3	1000009103	Shelf	91.1	100.0
RB 094-3	1000009403	Shelf	93.6	100.0
RB 096-3	1000009603	Shelf	96.1	100.0
RB 099-3	030100009900	Shelf	98.6	100.0
RB 101-3	1000010103	Shelf	101.1	115.0
RB 104-3	1000010403	Shelf	103.6	115.0
RB 106-3	1000010603	Shelf	106.1	115.0
RB 109-3	1000010903	Shelf	108.6	115.0
RB 111-3	1000011103	Shelf	111.1	115.0
RB 114-3	030100011400	Shelf	113.6	115.0
RB 116-3	1000011603	Shelf	116.1	125.0
RB 119-3	1000011903	Shelf	118.6	125.0
RB 121-3	1000012103	Shelf	121.1	125.0
RB 124-3	030100012400	Shelf	123.6	125.0
RB 126-3	1000012603	Shelf	126.1	150.0

**RB-3 SHELF**

Type	Order No.	Description	Width mm	Inside width mm
RB 129-3	1000012903	Shelf	128.6	150.0
RB 131-3	1000013103	Shelf	131.1	150.0
RB 134-3	1000013403	Shelf	133.6	150.0
RB 136-3	1000013603	Shelf	136.1	150.0
RB 139-3	1000013903	Shelf	138.6	150.0
RB 141-3	1000014103	Shelf	141.1	150.0
RB 144-3	1000014403	Shelf	143.6	150.0
RB 146-3	1000014603	Shelf	146.1	150.0
RB 149-3	030100014900	Shelf	148.6	150.0
RB 151-3	1000015103	Shelf	151.1	175.0
RB 154-3	1000015403	Shelf	153.6	175.0
RB 156-3	1000015603	Shelf	156.1	175.0
RB 159-3	1000015903	Shelf	158.6	175.0
RB 161-3	1000016103	Shelf	161.1	175.0
RB 164-3	1000016403	Shelf	163.6	175.0
RB 166-3	1000016603	Shelf	166.1	175.0
RB 169-3	1000016903	Shelf	168.6	175.0
RB 174-3	030100017400	Shelf	173.6	175.0

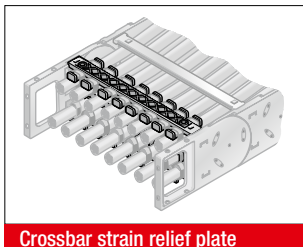
**RS-ZL-3 ZLA MP 35 CROSSBAR STRAIN RELIEF PLATE**

Fixed integrated frame bridge strain relief plates in the chain brackets. Tailored to all crossbar widths up to 175 mm. May be assembled on the inside and outside bends at both chain endings.

Type	Order No.	Description	Inside width mm
RS-ZL 050-3 ZLA MP 35	0351050010	Crossbar strain relief plate	50.0
RS-ZL 075-3 ZLA MP 35	0351075010	Crossbar strain relief plate	75.0
RS-ZL 100-3 ZLA MP 35	0351100010	Crossbar strain relief plate	100.0
RS-ZL 125-3 ZLA MP 35	0351125010	Crossbar strain relief plate	125.0
RS-ZL 150-3 ZLA MP 35	0351150010	Crossbar strain relief plate	150.0
RS-ZL 175-3 ZLA MP 35	0351175010	Crossbar strain relief plate	175.0

**STRAIN RELIEF WITH STEEL FIX**

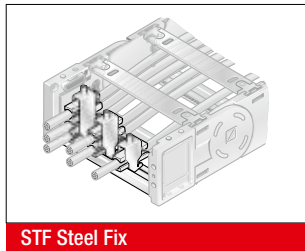
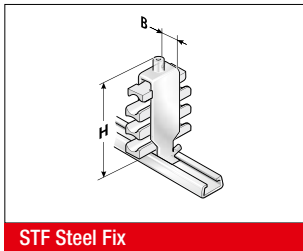

C-rails (galvanised) for permanent integration, for accommodating the Steel Fix bow clamps in the chain brackets. The bow clamps can take up to 3 cables and are suitable for C-rails with a groove width of 11 mm. Due to the design of the trough elements, a cable preserving cable guidance is ensured. May be assembled on the inside and outside bends at both chain endings. The overall height stated is a guide only. The actual height is, amongst other things, dependent on the diameter and the quality of the cable. A safety distance of 10 mm at the fixed point above the strain relief must be kept during gliding applications.

Type	Order No.	Description	Seats qty.	Cable Ø mm	Width mm	Total height (H) mm
<b>Single clamp (for one cable)</b>						
STF 12-1 Steel Fix	81661801	Hooped clamp	1	6.0 – 12.0	16.0	55.0
STF 14-1 Steel Fix	81661802	Hooped clamp	1	12.0 – 14.0	18.0	52.0
STF 16-1 Steel Fix	81661803	Hooped clamp	1	14.0 – 16.0	20.0	54.0
STF 18-1 Steel Fix	81661804	Hooped clamp	1	16.0 – 18.0	22.0	56.0
STF 20-1 Steel Fix	81661805	Hooped clamp	1	18.0 – 20.0	24.0	59.0
STF 22-1 Steel Fix	81661806	Hooped clamp	1	20.0 – 22.0	26.0	61.0
STF 26-1 Steel Fix	81661807	Hooped clamp	1	22.0 – 26.0	30.0	70.0
STF 30-1 Steel Fix	81661808	Hooped clamp	1	26.0 – 30.0	34.0	74.0
STF 34-1 Steel Fix	81661809	Hooped clamp	1	30.0 – 34.0	38.0	78.0
STF 38-1 Steel Fix	81661810	Hooped clamp	1	34.0 – 38.0	42.0	82.0
STF 42-1 Steel Fix	81661811	Hooped clamp	1	38.0 – 42.0	46.0	91.0
<b>Double clamp (for two cables)</b>						
STF 12-2 Steel Fix	81661821	Hooped clamp	2	6.0 – 12.0	16.0	73.0
STF 14-2 Steel Fix	81661822	Hooped clamp	2	12.0 – 14.0	18.0	74.0
STF 16-2 Steel Fix	81661823	Hooped clamp	2	14.0 – 16.0	20.0	82.0
STF 18-2 Steel Fix	81661824	Hooped clamp	2	16.0 – 18.0	22.0	86.0
STF 20-2 Steel Fix	81661825	Hooped clamp	2	18.0 – 20.0	24.0	91.0
STF 22-2 Steel Fix	81661826	Hooped clamp	2	20.0 – 22.0	26.0	95.0
STF 26-2 Steel Fix	81661827	Hooped clamp	2	22.0 – 26.0	30.0	108.0
STF 30-2 Steel Fix	81661828	Hooped clamp	2	26.0 – 30.0	34.0	121.0
STF 34-2 Steel Fix	81661829	Hooped clamp	2	30.0 – 34.0	38.0	129.0
<b>Triple clamp (for three cables)</b>						
STF 12-3 Steel Fix	81661841	Hooped clamp	3	6.0 – 12.0	16.0	98.0
STF 14-3 Steel Fix	81661842	Hooped clamp	3	12.0 – 14.0	18.0	98.0
STF 16-3 Steel Fix	81661843	Hooped clamp	3	14.0 – 16.0	20.0	105.0
STF 18-3 Steel Fix	81661844	Hooped clamp	3	16.0 – 18.0	22.0	111.0
STF 20-3 Steel Fix	81661845	Hooped clamp	3	18.0 – 20.0	24.0	118.0
STF 22-3 Steel Fix	81661846	Hooped clamp	3	20.0 – 22.0	26.0	130.0

**MP 35 LOWERED FIXING POINT**

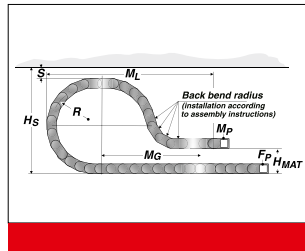
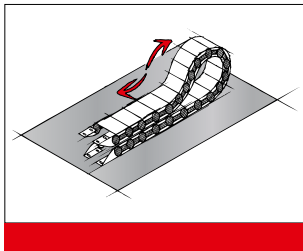

It is sometimes necessary to lower the height of the moving attachment point.

In such cases, modifications to the chain layout should be noted (e.g. extension of chain).

Please contact our application engineers.

Radius R mm	Height of moving end bracket ( $H_{MA}$ ) mm	Safety margin (S) mm	Installation height incl. safety ( $H_S$ ) mm	Projection ( $M_L$ ) mm	Additional links qty.	of which additional back chain links qty.
150.0	180.0	50.0	399.0	590.0	12	4
175.0	180.0	50.0	449.0	680.0	15	4
200.0	180.0	50.0	499.0	780.0	18	5
250.0	180.0	50.0	599.0	980.0	24	5

**GUIDE CHANNEL VAW (ALUMINIUM / STAINLESS STEEL)**



VAW steel galvanised / stainless steel

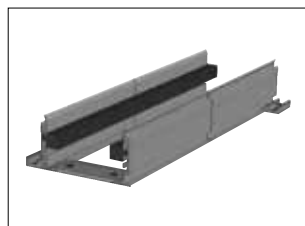

VAW aluminium

A range of variable guide channel systems, constructed from aluminium or stainless steel sections, are available for this energy chain.

The variable guide channel ensures that the energy chain is supported and guided securely.



**ASSEMBLY**

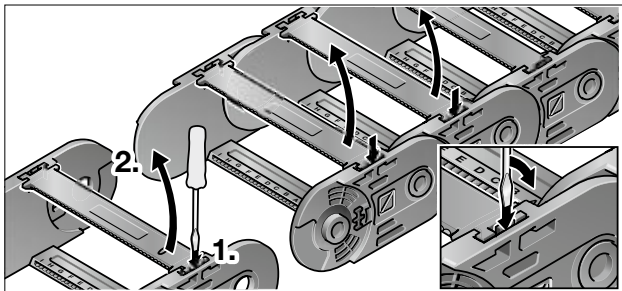

Step 1

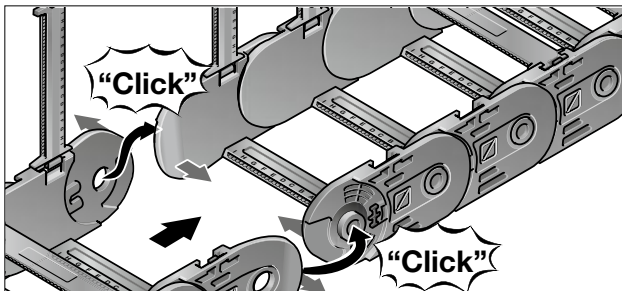

Step 2

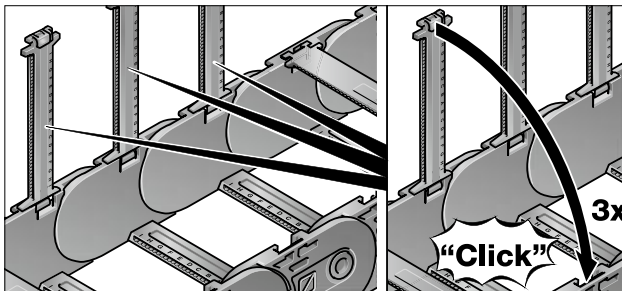

Step 3

**DISASSEMBLY**

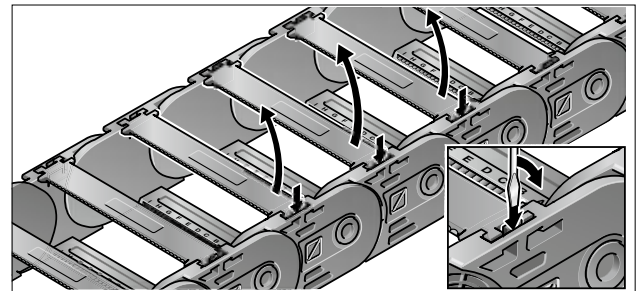

Step 1

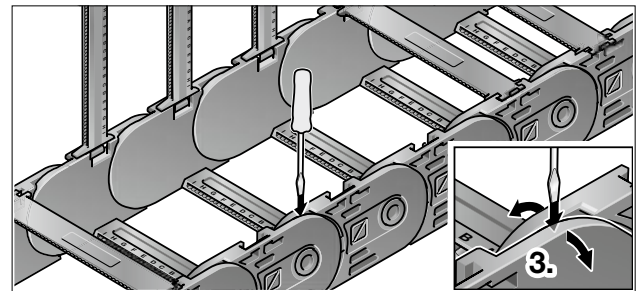

Step 2

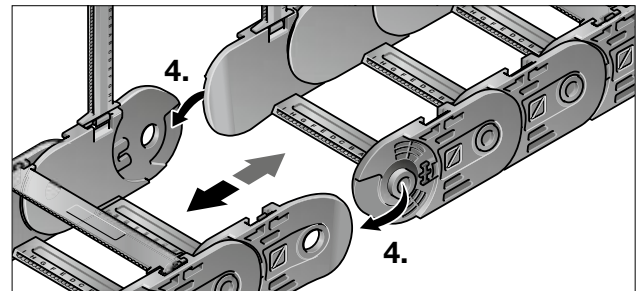

Step 3

## MP 36G

CLOSED



- CLOSED VARIANTS, STARTING WITH R80
- METAL CHAIN BRACKET

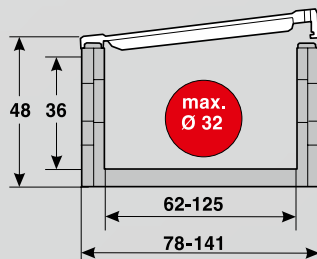

### TECHNICAL DATA

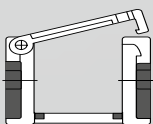

**Loading side**  
Inside bend

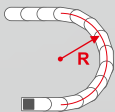

**Available radii**  
80.0 – 200.0 mm

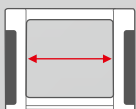

**Available interior widths**  
With plastic crossbar  
62.0 – 125.0 mm

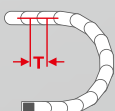

**Pitch**  
T = 40.0 mm



## TECHNICAL SPECIFICATIONS

Travel distance gliding $L_g$ max.	60.0 m
Travel distance self-supporting $L_s$ max.	see diagram on page 129
Travel distance vertical, hanging $L_{vh}$ max.	30.0 m
Travel distance vertical, upright $L_{vs}$ max.	3.0 m
Rotated 90°, unsupported $L_{90f}$ max.	1.0 m
Speed, gliding $V_g$ max.	3.0 m/s
Speed, self-supporting $V_s$ max.	10.0 m/s
Acceleration, gliding $a_g$ max.	15.0 m/s <sup>2</sup>
Acceleration, self-supporting $a_s$ max.	20.0 m/s <sup>2</sup>

Contact our engineering department to meet any higher requirements: [efk@murrplastik.de](mailto:efk@murrplastik.de)



## MATERIAL PROPERTIES

Standard material	Polyamide (PA) black
Service temperature	-30.0 – 120.0 °C
Gliding friction factor	0.3
Static friction factor	0.45
Fire classification	Based on UL 94 HB

Other material properties on request.

### CHAIN BRACKET

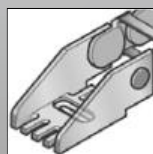

Chain bracket U-part

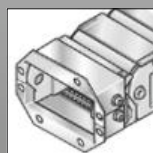

End brackets flange

### SHELVING SYSTEM

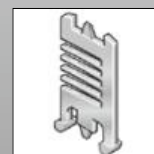

Separator TR



RS shelving system

### GUIDE CHANNELS



VAW steel galvanised / stainless steel



VAW aluminium

**ORDERING KEY**

Dimensions in mm [US inch]

Type code	Variation	Inside width	Outside width	Inside width	Outside width	Radius	Crossbar variant	Material	Chain length
<b>0360 04</b>	Cover on outside bend Cover on inside bend Opens on inside bend	<b>062</b> [2.44]	<b>078</b> [3.07]			<b>080</b> [3.15]	<b>0</b> Plastic, full-ridged with bias	<b>0</b> Polyamide standard (PA/black)	
		<b>086</b> [3.39]	<b>102</b> [4.02]						
		<b>102</b> [4.02]	<b>118</b> [4.65]			<b>100</b> [3.94]		<b>9</b> Special version (on request)	
		<b>125</b> [4.92]	<b>141</b> [5.55]			<b>125</b> [4.92]			
						<b>150</b> [5.91]			
						<b>200</b> [7.87]			

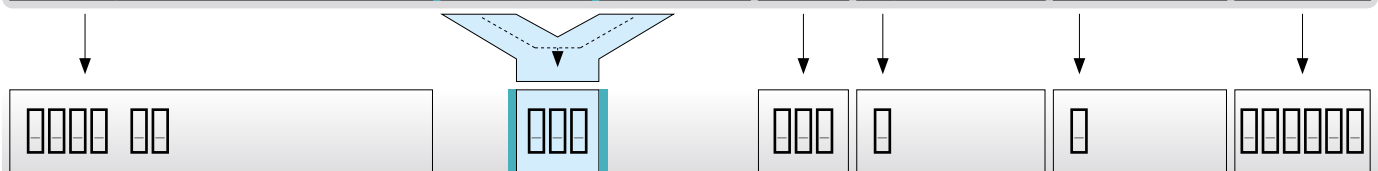

**ORDERING EXAMPLE: 0360 04 062 080 0 0 1280**

Cover on outside bend, cover on inside bend, openable from inside bend  
 Inside width 62 mm; radius 80 mm  
 Plastic crossbar, full-ridged with bias, material black-coloured polyamide  
 Chain length 1280 mm (32 links)

**SELF-SUPPORTING LENGTH**

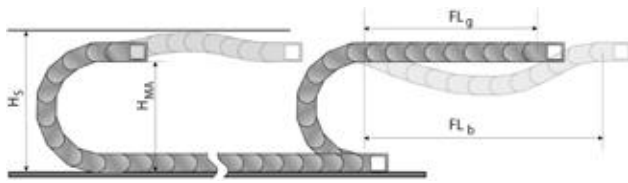

The self-supporting length is the distance between the chain bracket on the moving end and the start of the chain arch.  
 The installation variant  $FL_g$  offers the lowest load and wear for the energy chain.  
 The maximum travel parameters (speed and acceleration) can be applied for this variant.

- $H_s$  = Installation height plus safety
- $H_{MA}$  = Height of moving end connection
- $FL_g$  = Self-supporting length, upper run straight
- $FL_b$  = Self-supporting length, upper run bent

**LOAD DIAGRAM FOR SELF-SUPPORTING APPLICATIONS**

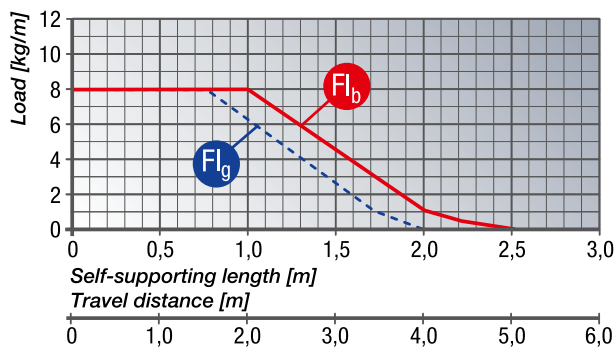

**$FL_g$  Self-supporting length, upper run straight**  
 In the  $FL_g$  range, the chain upper run still has a bias, is straight or has a maximum sag of 60.0 mm.

**$FL_b$  Self-supporting length, upper run bent**  
 In the  $FL_b$  range, the chain upper run has a sag of more than 60.0 mm, but this is still less than the maximum sag. Where the sag is greater than that permitted in the  $FL_b$  range, the application is critical and should be avoided. The self-supporting length can be optimised by using a support for the upper run or a more stable energy chain.

**DETERMINING THE CHAIN LENGTH**

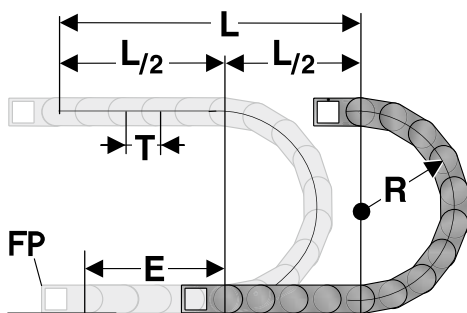

The fixed point of the energy chain should be connected in the middle of the travel distance.  
 This arrangement gives the shortest connection between the fixed point and the moving consumer and thus the most efficient chain length.

Chain length calculation =  $L/2 + \pi * R + 2 * T + E$   
 $\approx 1 \text{ m chain} = 25 \text{ qty. } \times 40.0 \text{ mm.}$

- E = Distance between entry point and middle of travel distance
- L = Travel distance
- R = Radius
- P = Pitch 40.0 mm

**INSTALLATION DIMENSIONS**

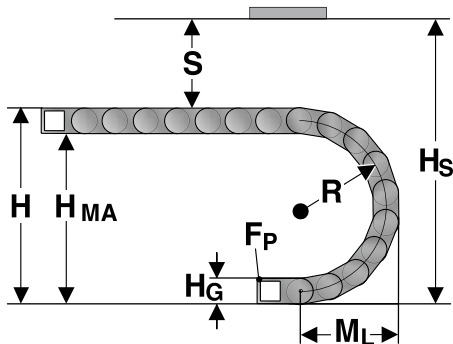

The moving end chain connection is to be screw fixed at height  $H_{MA}$  for the respective radius.  
For the installed dimension the “Installed height  $H_S$ ” value has to be taken into account.

Radius R	80	100	125	150	200
Outside height of chain link ( $H_G$ )	48	48	48	48	48
Height of bend (H)	208	248	298	348	448
Height of moving end bracket ( $H_{MA}$ )	160	200	250	300	400
Safety margin (S)	32	32	32	32	32
Installation height ( $H_S$ )	240	280	330	380	480
Arc projection ( $M_L$ )	144	164	189	214	264

**KA 36 G CHAIN BRACKET U-PART**

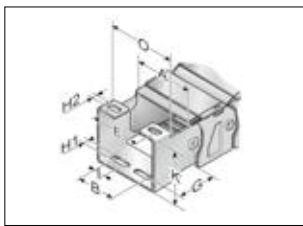

KA 36062 – 36125

The chain bracket can be supplied either in galvanised sheet steel or stainless steel. To secure one energy chain, you will need a bracket with a drilled hole and a bracket with a bolt.

Type	Order No.	Material	Inside width							Outside width of KA 0 mm
			A mm	E mm	G mm	H1 mm	H2 mm	I mm	K mm	
KA 36062 C Female end	036000001000	Sheet steel	62.0	A-7.5	42.0	6.6	6.6	6.0	48.8	A+12.0
KA 36062 C Male end	036000001100	Sheet steel	62.0	A-7.5	42.0	6.6	6.6	6.0	48.8	A+8.0
KA 36086 C Female end	036000001200	Sheet steel	86.0	A-7.5	42.0	6.6	6.6	15.5	48.8	A+12.0
KA 36086 C Male end	036000001300	Sheet steel	86.0	A-7.5	42.0	6.6	6.6	15.5	48.8	A+8.0
KA 36102 C Female end	036000001400	Sheet steel	102.0	A-7.5	42.0	6.6	6.6	15.5	48.8	A+12.0
KA 36102 C Male end	036000001500	Sheet steel	102.0	A-7.5	42.0	6.6	6.6	15.5	48.8	A+8.0
KA 36125 C Female end	036000001600	Sheet steel	125.0	A-7.5	42.0	6.6	6.6	15.5	48.8	A+12.0
KA 36125 C Male end	036000001700	Sheet steel	125.0	A-7.5	42.0	6.6	6.6	15.5	48.8	A+8.0
KA 36062 C Female end	036000002000	Stainless steel 1.4301	62.0	A-7.5	42.0	6.6	6.6	6.0	48.8	A+12.0
KA 36062 C Male end	036000002100	Stainless steel 1.4301	62.0	A-7.5	42.0	6.6	6.6	6.0	48.8	A+8.0
KA 36086 C Female end	036000002200	Stainless steel 1.4301	86.0	A-7.5	42.0	6.6	6.6	15.5	48.8	A+12.0
KA 36086 C Male end	036000002300	Stainless steel 1.4301	86.0	A-7.5	42.0	6.6	6.6	15.5	48.8	A+8.0
KA 36102 C Female end	036000002400	Stainless steel 1.4301	102.0	A-7.5	42.0	6.6	6.6	15.5	48.8	A+12.0
KA 36102 C Male end	036000002500	Stainless steel 1.4301	102.0	A-7.5	42.0	6.6	6.6	15.5	48.8	A+8.0
KA 36125 C Female end	036000002600	Stainless steel 1.4301	125.0	A-7.5	42.0	6.6	6.6	15.5	48.8	A+12.0
KA 36125 C Male end	036000002700	Stainless steel 1.4301	125.0	A-7.5	42.0	6.6	6.6	15.5	48.8	A+8.0

**KA 36 G END BRACKETS FLANGE**

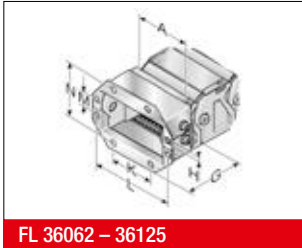

FL 36062 – 36125

An energy chain requires two chain brackets. The divisible flange connection has been specifically designed for commissioning and re-installation. This keeps the chain in the installed position.

Type	Order No.	Material	Inside width					
			A mm	HØ mm	K mm	L mm	M mm	N mm
FL 36062	0360062054	Sheet steel	62.0	7.0	40.0	97.9	18.0	68.5
FL 36086	0360086054	Sheet steel	86.0	7.0	64.0	121.9	18.0	68.5
FL 36102	0360102054	Sheet steel	102.0	7.0	80.0	137.9	18.0	68.5
FL 36125	0360125054	Sheet steel	125.0	7.0	103.0	160.9	18.0	68.5
FL 36062	0360062056	Stainless steel 1.4301	62.0	7.0	40.0	97.9	18.0	68.5
FL 36086	0360086056	Stainless steel 1.4301	86.0	7.0	64.0	121.9	18.0	68.5
FL 36102	0360102056	Stainless steel 1.4301	102.0	7.0	80.0	137.9	18.0	68.5
FL 36125	0360125056	Stainless steel 1.4301	125.0	7.0	103.0	160.9	18.0	68.5

**TR 36G SEPARATOR**

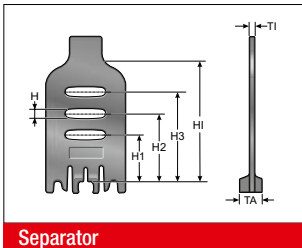

Separator

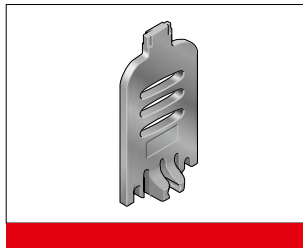

We recommend that separators be used if multiple round cables or conduits with differing diameters are to be installed.

Type	Order No.	Description	Version	TI mm	TA mm	H mm	H1 mm	H2 mm	H3 mm	H4 mm
TR 36G	036000009200	Separator	lockable	2.5	10.5	2.5	13.5	19.5	25.5	36.5

**MP 36G SHELVING SYSTEM**

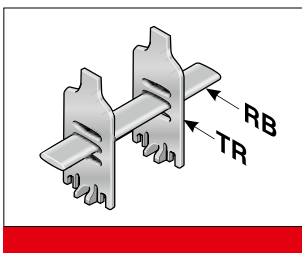

The shelf must be used with a minimum of two separators to create a shelving system. The additional levels prevent cables from criss-crossing and minimise the friction between them. The shelves are matched to the available chain widths.

Type	Order No.	Description	Width mm	Pitch mm
RBT 062	100000006200	Shelf	62.0	2.5
RBT 086	100000008600	Shelf	86.0	2.5
RBT 101	100000010100	Shelf	101.0	2.5
RBT 125	100000012500	Shelf	125.0	2.5

**GUIDE CHANNEL VAW (ALUMINIUM / STAINLESS STEEL)**



A range of variable guide channel systems, constructed from aluminium or stainless steel sections, are available for this energy chain. The variable guide channel ensures that the energy chain is supported and guided securely.

**ASSEMBLY**

**DISASSEMBLY**

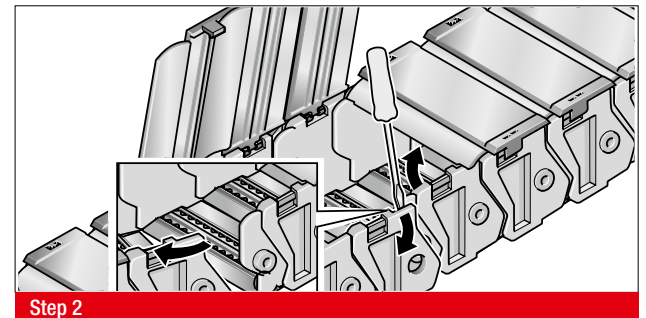
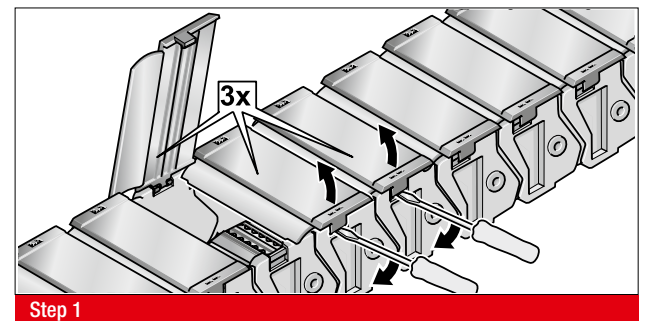
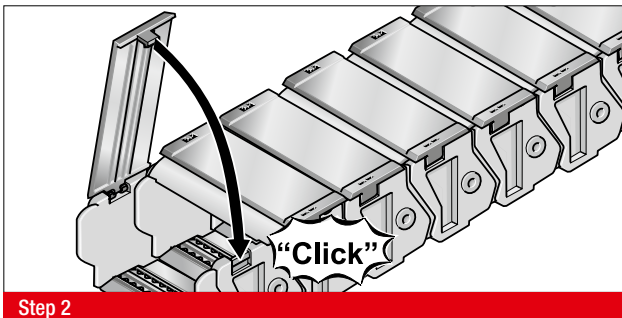
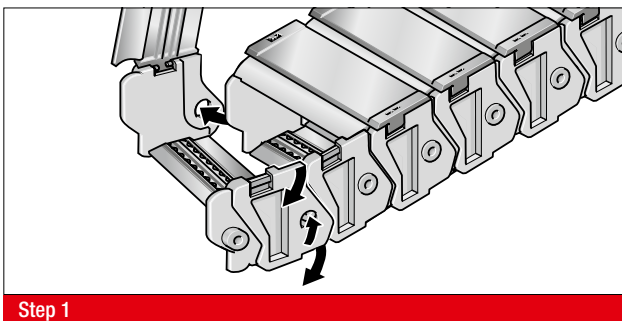





## MP 43G

CLOSED



- METAL CHAIN BRACKET
- OPENS ON INSIDE AND OUTSIDE BEND

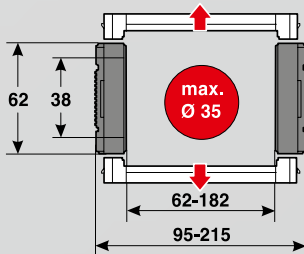

### TECHNICAL DATA

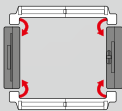

**Loading side**  
Inside and outside bend

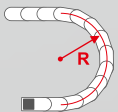

**Available radii**  
125.0 – 400.0 mm

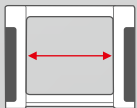

**Available interior widths**  
With plastic crossbar  
62.0 – 182.0 mm

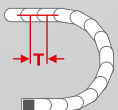

**Pitch**  
T = 75.5 mm

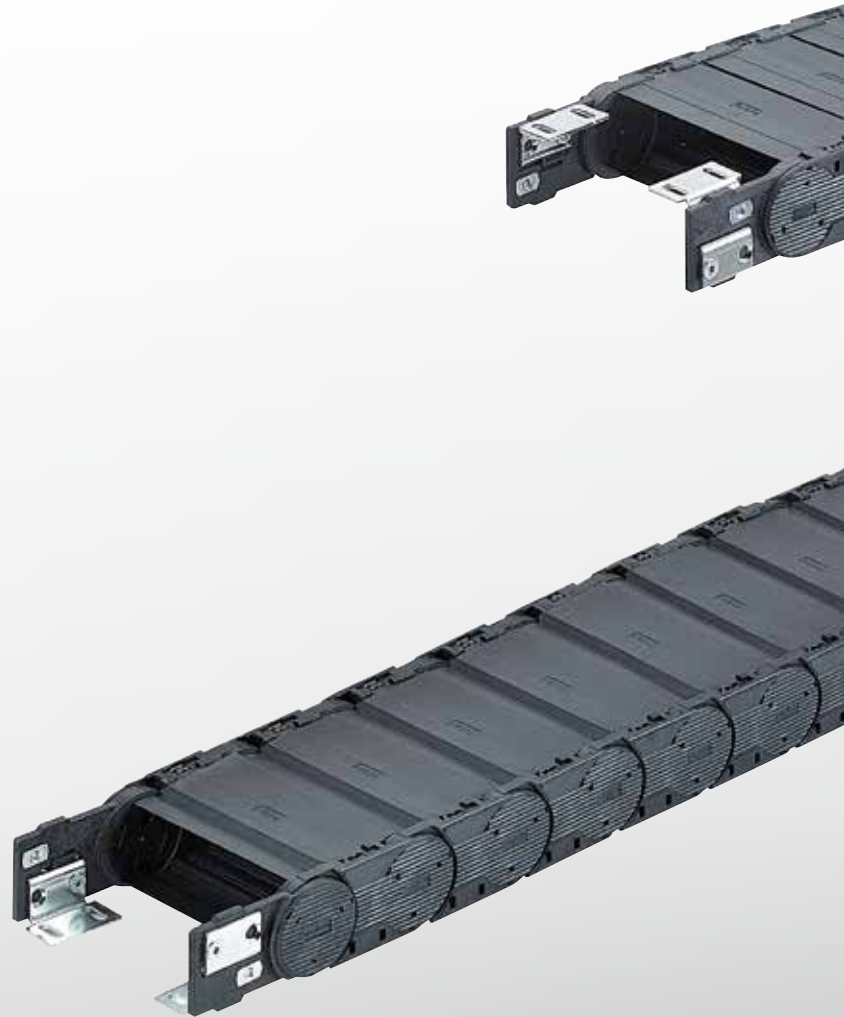

## TECHNICAL SPECIFICATIONS

Travel distance gliding $L_g$ max.	50.0 m
Travel distance self-supporting $L_s$ max.	see diagram on page 137
Travel distance vertical, hanging $L_{vh}$ max.	40.0 m
Travel distance vertical, upright $L_{vs}$ max.	3.0 m
Rotated 90°, unsupported $L_{90f}$ max.	1.0 m
Speed, gliding $V_g$ max.	5.0 m/s
Speed, self-supporting $V_s$ max.	15.0 m/s
Acceleration, gliding $a_g$ max.	15.0 m/s <sup>2</sup>
Acceleration, self-supporting $a_s$ max.	20.0 m/s <sup>2</sup>

Contact our engineering department to meet any higher requirements: [efk@murrplastik.de](mailto:efk@murrplastik.de)



## MATERIAL PROPERTIES

Standard material	Polyamide (PA) black
Service temperature	-30.0 – 120.0 °C
Gliding friction factor	0.3
Static friction factor	0.45
Fire classification	Based on UL 94 HB

Other material properties on request.

## SHELVING SYSTEM

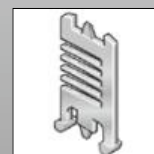

Separator TR

## CHAIN BRACKET

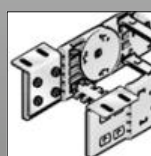

Chain bracket angle



RS shelving system

## GUIDE CHANNELS



VAW aluminium

**ORDERING KEY**

Dimensions in mm [US inch]

Type code	Variation	Inside width	Outside width	Inside width	Outside width	Radius	Crossbar variant	Material	Chain length
<b>0430 44</b>	Cover on outside bend Cover on inside bend Opens on inside and outside bend	<b>062</b> [2.44]	<b>095</b> [3.74]			<b>125</b> [4.92]	<b>0</b> Plastic, full-ridged with bias	<b>0</b> Polyamide standard (PA/black)	
		<b>084</b> [3.31]	<b>117</b> [4.61]						
		<b>105</b> [4.13]	<b>138</b> [5.43]			<b>150</b> [5.91]	<b>1</b> Plastic, full-ridged without bias	<b>9</b> Special version (on request)	
		<b>144</b> [5.67]	<b>177</b> [6.97]						
		<b>182</b> [7.17]	<b>215</b> [8.46]			<b>200</b> [7.87]	<b>9</b> Special version (on request)		
						<b>250</b> [9.84]			
						<b>300</b> [11.81]			
						<b>400</b> [15.75]			

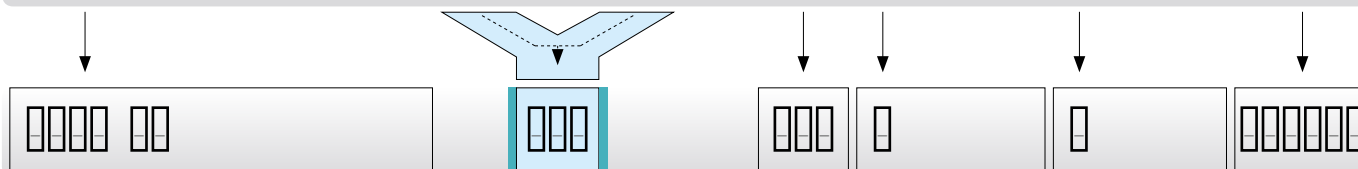

**ORDERING EXAMPLE: 0430 44 062 125 0 0 1435**

Cover on outside bend, cover on inside bend, openable from inside and outside bend  
 Inside width 62 mm; radius 125 mm  
 Plastic crossbar, full-ridged with bias, material black-coloured polyamide  
 Chain length 1435 mm (19 links)

**SELF-SUPPORTING LENGTH**

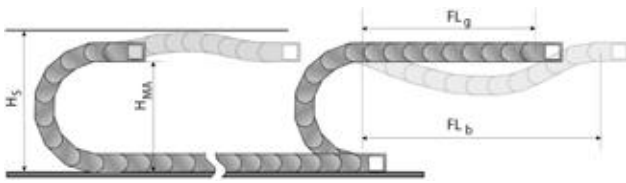

The self-supporting length is the distance between the chain bracket on the moving end and the start of the chain arch.  
 The installation variant  $FL_g$  offers the lowest load and wear for the energy chain.  
 The maximum travel parameters (speed and acceleration) can be applied for this variant.

- $H_s$  = Installation height plus safety
- $H_{MA}$  = Height of moving end connection
- $FL_g$  = Self-supporting length, upper run straight
- $FL_b$  = Self-supporting length, upper run bent

**LOAD DIAGRAM FOR SELF-SUPPORTING APPLICATIONS**

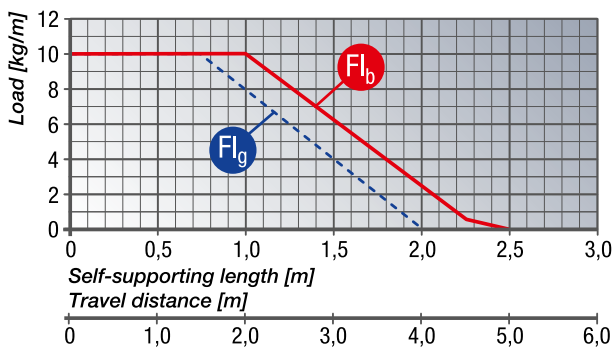

**$FL_g$  Self-supporting length, upper run straight**  
 In the  $FL_g$  range, the chain upper run still has a bias, is straight or has a maximum sag of 60.0 mm.

**$FL_b$  Self-supporting length, upper run bent**  
 In the  $FL_b$  range, the chain upper run has a sag of more than 60.0 mm, but this is still less than the maximum sag. Where the sag is greater than that permitted in the  $FL_b$  range, the application is critical and should be avoided. The self-supporting length can be optimised by using a support for the upper run or a more stable energy chain.

**DETERMINING THE CHAIN LENGTH**

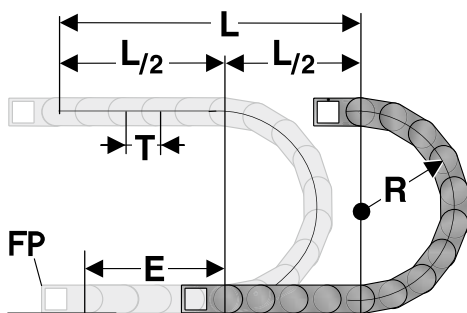

The fixed point of the energy chain should be connected in the middle of the travel distance.  
 This arrangement gives the shortest connection between the fixed point (FP) and the moving consumer and thus the most efficient chain length.

Chain length calculation =  $L/2 + \pi * R + E$   
 $\approx 1 \text{ m chain} = 13 \text{ qty. } \times 75.5 \text{ mm.}$

- E = Distance between entry point and middle of travel distance
- L = Travel distance
- R = Radius
- P = Pitch 75.5 mm

**INSTALLATION DIMENSIONS**

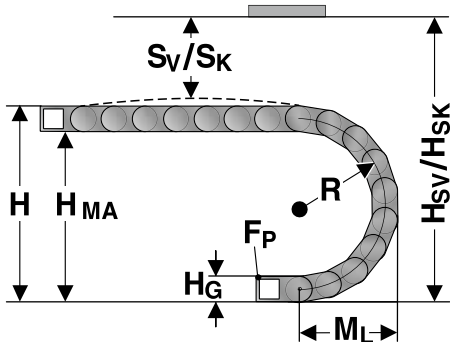

The moving end chain connection is to be screw fixed at height  $H_{MA}$  for the respective radius.

Concerning the installed dimensions, you must take into account whether the chain links are equipped with or without bias.

For chain links without bias, the “Installed height without bias  $H_{sk}$ ” value has to be taken into account.

If the chain links are equipped with a bias, the value “Installed height with bias  $H_{sv}$ ” has to be taken into account.

Radius R	125	150	200	250	300	400
Outside height of chain link ( $H_g$ )	62	62	62	62	62	62
Height of bend (H)	312	362	462	562	662	862
Height of moving end bracket ( $H_{MA}$ )	250	300	400	500	600	800
Safety margin with bias ( $S_v$ )	38	38	38	38	38	38
Installation height with bias ( $H_{sv}$ )	350	400	500	600	700	900
Safety margin without bias ( $S_k$ )	13	13	13	13	13	13
Installation height without bias ( $H_{sk}$ )	325	375	475	575	675	875
Arc projection ( $M_L$ )	232	257	307	357	407	507

**KA 44 CHAIN BRACKET ANGLE**

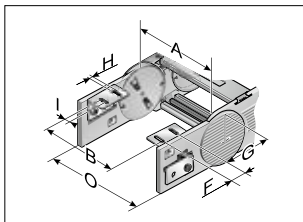

KA 44 (inside up / down)

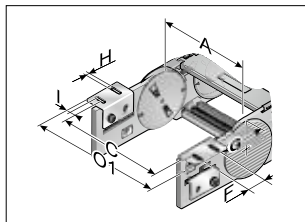

KA 44 (outside up / down)

There are several options regarding the chain bracket. The fixed-point bracket (inside/bottom) and the moving end bracket (inside/top) are supplied as standard. However, any other combination can be supplied upon request. The chain bracket is fastened at the end like a side link. This enables the chain to move right up to the bracket. Each chain requires two chain brackets. The brackets should be fastened with M6 screws.

Type	Order No.	Material	Inside width								Outside width of KA 0	Outside width of KA 01	
			A mm	B mm	C mm	E mm	F mm	G mm	G1 mm	H0 mm			I mm
KA 44	0440000050	Sheet steel	62.0 – 182.0	A-14.5	A+38.5	A+32.0	32.0	43.2	86.0	6.5	12.5	A+33.0	A+64.0
KA 44	0440000052	Stainless steel 1.4301	62.0 – 182.0	A-14.5	A+38.5	A+32.0	32.0	43.2	86.0	6.5	12.5	A+33.0	A+64.0

**TR 43G SEPARATOR**

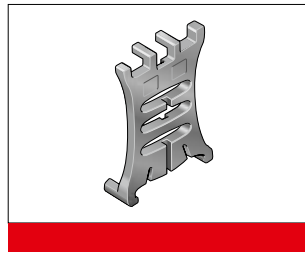
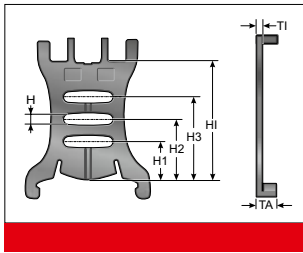

We recommend that separators be used if multiple round cables or conduits with differing diameters are to be installed.

Type	Order No.	Description	Version	TI mm	TA mm	H mm	H1 mm	H2 mm	H3 mm	HI mm
TF 43	0430000090	Separator	moveable	4.0	9.0	4.3	12.3	19.5	26.5	38.0

**MP 43G SHELVING SYSTEM**

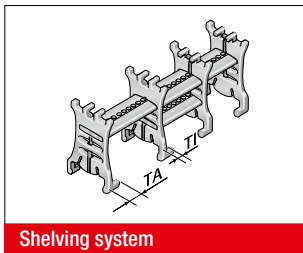

Shelving system

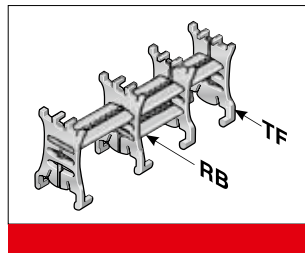

The shelf must be used with a minimum of two separators to create a shelving system. The additional levels prevent cables from criss-crossing and minimise the friction between them. The shelves are matched to the available chain widths.

Type	Order No.	Description	Width mm	Clearance width mm	Pitch mm
RB 031	100000003100	Shelf	42.0	31.0	1.6
RB 048	100000004800	Shelf	59.0	48.0	1.6
RB 070	100000007000	Shelf	81.0	70.0	1.6
RB 092	100000009200	Shelf	103.0	92.0	1.6
RB 128	100000012800	Shelf	139.0	128.0	1.6
RB 167	100000016700	Shelf	178.0	167.0	1.6

**GUIDE CHANNEL VAW (ALUMINIUM)**



VAW aluminium

A variable guide channel system, constructed from aluminium sections, is available for this energy chain. The variable guide channel ensures that the energy chain is supported and guided securely.

ASSEMBLY

DISASSEMBLY

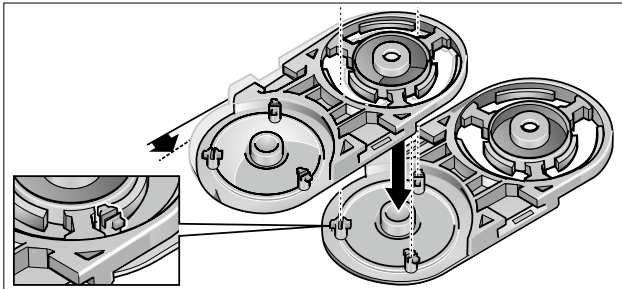

Step 1

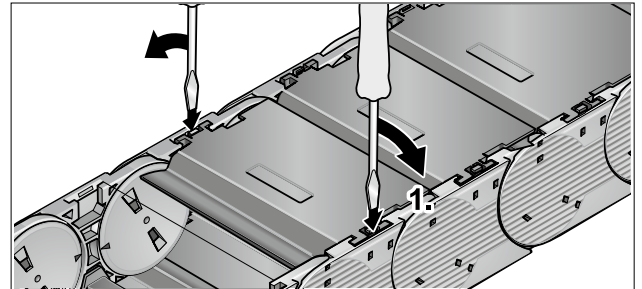

Step 1

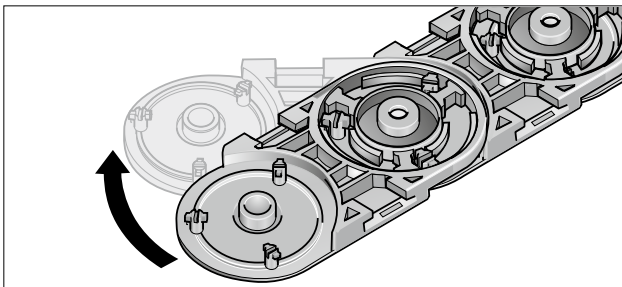

Step 2

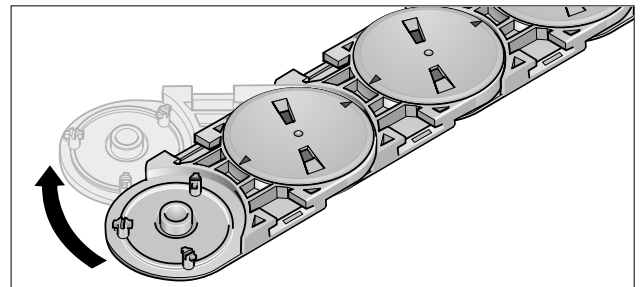

Step 2

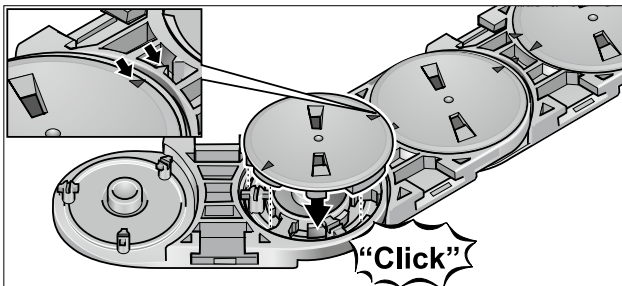

Step 3

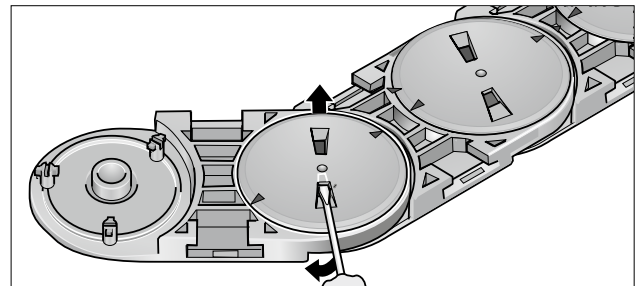

Step 3

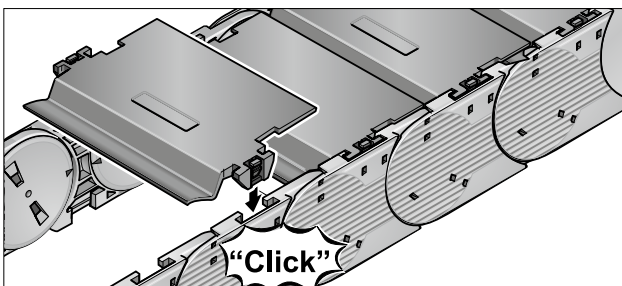

Step 4

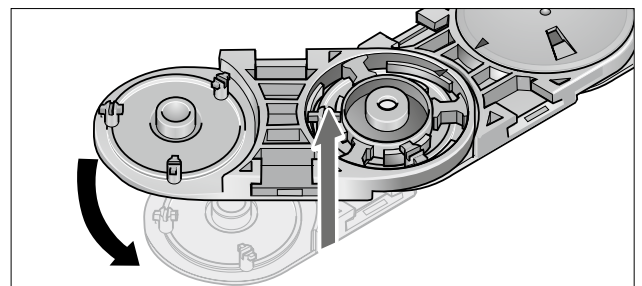

Step 4

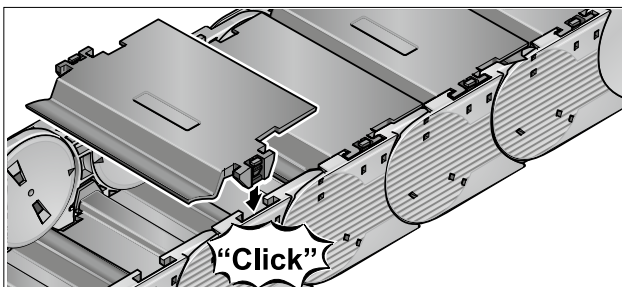

Step 5





**MP 45.1**  
OPEN



**MP 45.2**  
OPEN



- LOW-COST VARIANT
- SOFT-STOP SYSTEM
- SUITABLE FOR UNIVERSAL USE
- CHAIN BRACKET WITH INTEGRATED STRAIN RELIEF
- BROAD INTERIOR LAYOUT

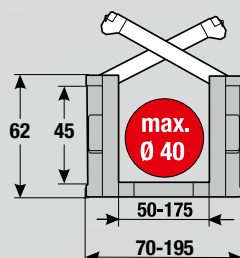

## TECHNICAL DATA

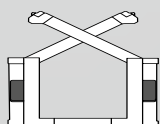

**Loading side**  
Inside or outside bend

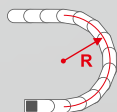

**Available radii**  
75.0 – 300.0

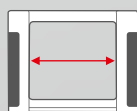

**Available interior widths**  
With plastic crossbar  
50.0 – 175.0

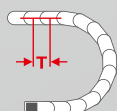

**Pitch**  
T = 67.0 mm



**Noise attenuator**  
Reduction of the noise emission by up to 10 dB(A) by the use of damping elements in the chain links.





## TECHNICAL SPECIFICATIONS

Travel distance gliding $L_g$ max.	80.0 m
Travel distance self-supporting $L_s$ max.	see diagram on page 145
Travel distance vertical, hanging $L_{vh}$ max.	60.0 m
Travel distance vertical, upright $L_{vs}$ max.	4.0 m
Rotated 90°, unsupported $L_{90f}$ max.	1.0 m
Speed, gliding $V_g$ max.	5.0 m/s
Speed, self-supporting $V_f$ max.	20.0 m/s
Acceleration, gliding $a_g$ max.	15.0 m/s <sup>2</sup>
Acceleration, self-supporting $a_s$ max.	50.0 m/s <sup>2</sup>

Contact our engineering department to meet any higher requirements: [efk@murrplastik.de](mailto:efk@murrplastik.de)

## MATERIAL PROPERTIES

Standard material	Polyamide (PA) black
Service temperature	-30.0 – 120.0 °C
Gliding friction factor	0.3
Static friction factor	0.45
Fire classification	UL 94 HB

Other material properties on request.

### CHAIN BRACKET

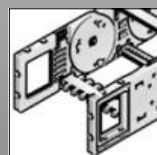

Chain bracket flexible

### SHELVING SYSTEM

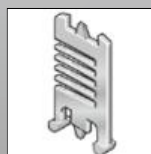

Separator TR

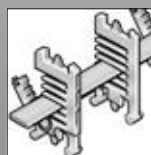

RS shelving system

### GUIDE CHANNELS



VAW steel galvanised / stainless steel

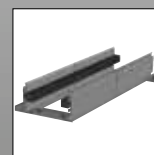

VAW aluminium

### STRAIN RELIEF

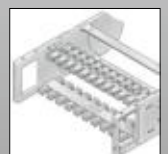

RS-ZL crossbar strain relief



STF Steel Fix

**ORDERING KEY**

Dimensions in mm [US inch]

Type code	Variation	Inside width	Outside width	Inside width	Outside width	Radius	Crossbar variant	Material	Chain length																																																																				
0451 01	MP 45.1 open Crossbar on outside bend Crossbar on inside bend Opens on outside bend	050 [1.97]	070 [2.76]			075 [2.95]	0 Plastic, full-ridged with bias	2 Polyamide without attenuator (PA/black)																																																																					
		075 [2.95]	095 [3.74]							0452 02	MP 45.2 open Crossbar on outside bend Crossbar on inside bend Opens on inside bend	100 [3.94]	120 [4.72]			100 [3.94]	1 Plastic, full-ridged without bias	3 Polyamide with attenuator (PA/black)		115 [4.53]	135 [5.31]					125 [4.92]	145 [5.71]			125 [4.92]		9 Special version (on request)				150 [5.91]	170 [6.69]			150 [5.91]						175 [6.89]	195 [7.68]			150 [5.91]										200 [7.87]										250 [9.84]							
0452 02	MP 45.2 open Crossbar on outside bend Crossbar on inside bend Opens on inside bend	100 [3.94]	120 [4.72]			100 [3.94]	1 Plastic, full-ridged without bias	3 Polyamide with attenuator (PA/black)																																																																					
		115 [4.53]	135 [5.31]									125 [4.92]	145 [5.71]			125 [4.92]		9 Special version (on request)				150 [5.91]	170 [6.69]			150 [5.91]						175 [6.89]	195 [7.68]			150 [5.91]										200 [7.87]										250 [9.84]										300 [11.81]											
		125 [4.92]	145 [5.71]			125 [4.92]		9 Special version (on request)																																																																					
		150 [5.91]	170 [6.69]			150 [5.91]																																																																							
		175 [6.89]	195 [7.68]			150 [5.91]																																																																							
						200 [7.87]																																																																							
						250 [9.84]																																																																							
						300 [11.81]																																																																							

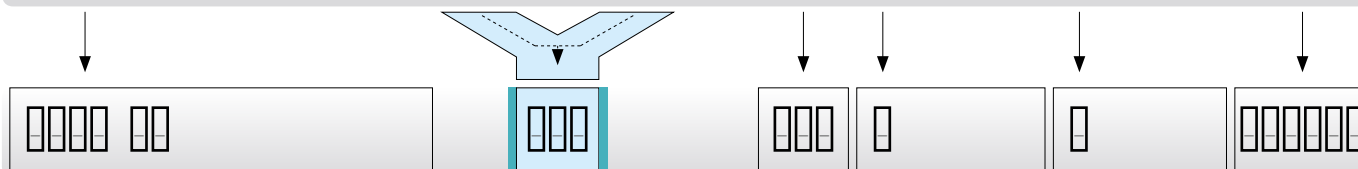

**ORDERING EXAMPLE: 0452 02 075 100 0 3 2000**

Crossbar on outside bend, crossbar on inside bend, can be opened from inside bend  
 Inside width 075 mm, radius 100 mm  
 Plastic, full-ridged with bias, material polyamide with damper (PA/black)  
 Chain length 2000 mm (30 links)

**SELF-SUPPORTING LENGTH**

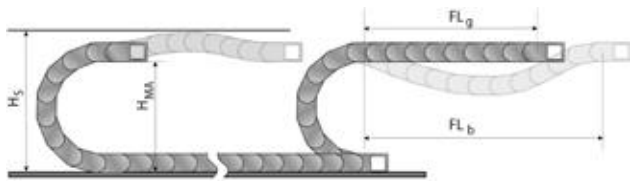

The self-supporting length is the distance between the chain bracket on the moving end and the start of the chain arch. The installation variant  $FL_g$  offers the lowest load and wear for the energy chain. The maximum travel parameters (speed and acceleration) can be applied for this variant.

- $H_s$  = Installation height plus safety
- $H_{MA}$  = Height of moving end connection
- $FL_g$  = Self-supporting length, upper run straight
- $FL_b$  = Self-supporting length, upper run bent

**LOAD DIAGRAM FOR SELF-SUPPORTING APPLICATIONS**

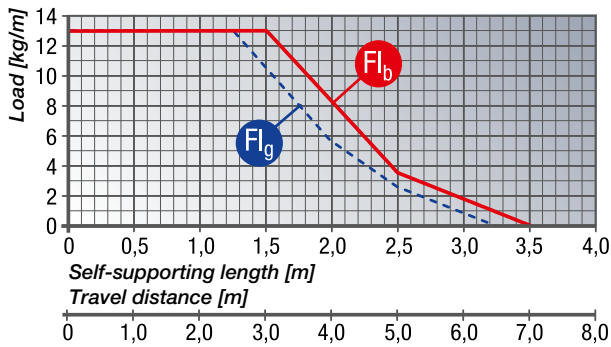

**$FL_g$  Self-supporting length, upper run straight**  
 In the  $FL_g$  range, the chain upper run still has a bias, is straight or has a maximum sag of 50.0 mm.

**$FL_b$  Self-supporting length, upper run bent**  
 In the  $FL_b$  range, the chain upper run has a sag of more than 50.0 mm, but this is still less than the maximum sag. Where the sag is greater than that permitted in the  $FL_b$  range, the application is critical and should be avoided. The self-supporting length can be optimised by using a support for the upper run or a more stable energy chain.

**DETERMINING THE CHAIN LENGTH**

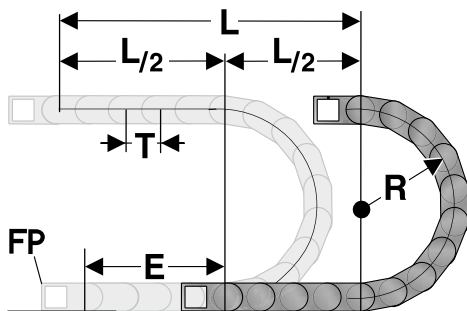

The fixed point of the energy chain should be connected in the middle of the travel distance. This arrangement gives the shortest connection between the fixed point (FP) and the moving consumer and thus the most efficient chain length.

Chain length calculation =  $L/2 + \pi * R + E$   
 $\approx 1 \text{ m chain} = 15 \text{ qty. } \times 67.0 \text{ mm.}$

- E = Distance between entry point and middle of travel distance
- L = Travel distance
- R = Radius
- P = Pitch 67.0 mm

**INSTALLATION DIMENSIONS**

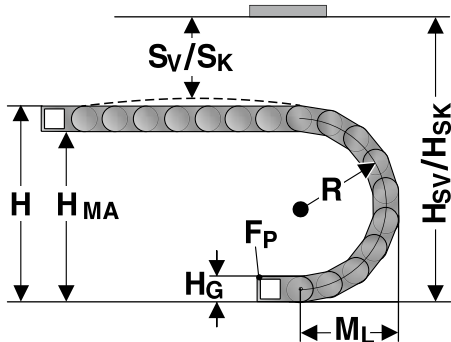

The moving end chain connection is to be screw fixed at height  $H_{MA}$  for the respective radius.  
 Concerning the installed dimensions, you must take into consideration whether the chain links are equipped with damping elements or not.  
 For chain links without damping elements, the value “Installed height with bias  $H_{SV}$  without damper” or “Installed height without bias  $H_{SK}$  without damper” must be taken into account.  
 If the chain links are equipped with a damping element, the value “Installed height with bias  $H_{SV}$  with damper” or “Installed height without bias  $H_{SK}$  with damper” is to be taken into account.

Radius R	75	100	125	150	200	250	300
Outside height of chain link ( $H_G$ )	62	62	62	62	62	62	62
Height of bend (H)	212	262	312	362	462	562	662
Height of moving end bracket ( $H_{MA}$ )	150	200	250	300	400	500	600
Safety margin with bias ( $S_V$ )	20	20	20	20	20	20	20
Installation height with bias ( $H_{SV}$ ) without damper	322	372	422	472	572	672	772
Installation height with bias ( $H_{SV}$ ) with damper	342	392	442	492	592	692	792
Safety margin without bias ( $S_K$ )	20	20	20	20	20	20	20
Installation height without bias ( $H_{SK}$ ) without damper	232	282	332	382	482	582	682
Installation height without bias ( $H_{SK}$ ) with damper	252	302	352	402	502	602	702
Arc projection ( $M_L$ )	173	198	223	248	298	348	398

**DAMPING ELEMENT FOR THE CHAIN LINKS**

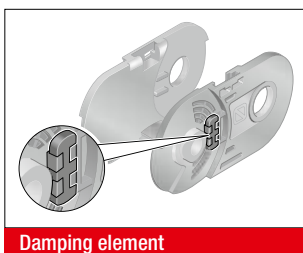

Damping element

The damping elements in the stops facilitate a significantly quieter unrolling of the chain links. The dampers can be chosen optionally.  
 A reduction of the noise emission by up to 10 dB(A) comparing to the variants without the use of damping elements is possible.

**KA 45 CHAIN BRACKET FLEXIBLE**

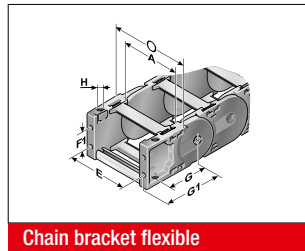
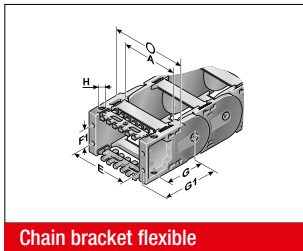

This chain bracket offers universal connection options (top, bottom and front) and is attached to the ends of the energy chain like a side link. This allows the chain to move right up to the bracket. Each energy chain requires one male and one female bracket. M5 screws are used to secure the brackets in place. Press-in metal bushes with a through-hole ensure the permanent, high-strength transmission of even extreme forces onto the energy chain.

By default, the chain bracket is supplied with frame bridges. The chain bracket can then be optionally fitted with frame bridge strain relief plates (RS-ZL) or with strain relief using C-rails and type STF bow clamps.

Type	Order No.	Material	Inside width							Outside width of KA O mm
			A mm	E mm	F1 mm	G mm	G1 mm	H0 mm		
KA 45-FB Female end, 050, complete	0450005050	Plastic	50.0	A+13.0	22.0	60.0	82.0	5.5	A+24.0	
KA 45-FB Female end, 050, pendular, complete	0450005052	Plastic	50.0	A+13.0	22.0	60.0	82.0	5.5	A+24.0	
KA 45-FB Male end, 050, complete	0450005051	Plastic	50.0	A+13.0	22.0	60.0	82.0	5.5	A+24.0	
KA 45-FB Male end, 050, pendular, complete	0450005053	Plastic	50.0	A+13.0	22.0	60.0	82.0	5.5	A+24.0	
KA 45-FB Female end, 075, complete	0450007550	Plastic	75.0	A+13.0	22.0	60.0	82.0	5.5	A+24.0	
KA 45-FB Female end, 075, pendular, complete	0450007552	Plastic	75.0	A+13.0	22.0	60.0	82.0	5.5	A+24.0	
KA 45-FB Male end, 075, complete	0450007551	Plastic	75.0	A+13.0	22.0	60.0	82.0	5.5	A+24.0	
KA 45-FB Male end, 075, pendular, complete	0450007553	Plastic	75.0	A+13.0	22.0	60.0	82.0	5.5	A+24.0	
KA 45-FB Female end, 100, complete	0450010050	Plastic	100.0	A+13.0	22.0	60.0	82.0	5.5	A+24.0	
KA 45-FB Female end, 100, pendular, complete	0450010052	Plastic	100.0	A+13.0	22.0	60.0	82.0	5.5	A+24.0	
KA 45-FB Male end, 100, complete	0450010051	Plastic	100.0	A+13.0	22.0	60.0	82.0	5.5	A+24.0	
KA 45-FB Male end, 100, pendular, complete	0450010053	Plastic	100.0	A+13.0	22.0	60.0	82.0	5.5	A+24.0	
KA 45-FB Female end, 115, complete	0450011550	Plastic	115.0	A+13.0	22.0	60.0	82.0	5.5	A+24.0	
KA 45-FB Female end, 115, pendular, complete	0450011552	Plastic	115.0	A+13.0	22.0	60.0	82.0	5.5	A+24.0	
KA 45-FB Male end, 115, complete	0450011551	Plastic	115.0	A+13.0	22.0	60.0	82.0	5.5	A+24.0	
KA 45-FB Male end, 115, pendular, complete	0450011553	Plastic	115.0	A+13.0	22.0	60.0	82.0	5.5	A+24.0	
KA 45-FB Female end, 125, complete	0450012550	Plastic	125.0	A+13.0	22.0	60.0	82.0	5.5	A+24.0	
KA 45-FB Female end, 125, pendular, complete	0450012552	Plastic	125.0	A+13.0	22.0	60.0	82.0	5.5	A+24.0	
KA 45-FB Male end, 125, complete	0450012551	Plastic	125.0	A+13.0	22.0	60.0	82.0	5.5	A+24.0	
KA 45-FB Male end, 125, pendular, complete	0450012553	Plastic	125.0	A+13.0	22.0	60.0	82.0	5.5	A+24.0	
KA 45-FB Female end, 150, complete	0450015050	Plastic	150.0	A+13.0	22.0	60.0	82.0	5.5	A+24.0	
KA 45-FB Female end, 150, pendular, complete	0450015052	Plastic	150.0	A+13.0	22.0	60.0	82.0	5.5	A+24.0	
KA 45-FB Male end, 150, complete	0450015051	Plastic	150.0	A+13.0	22.0	60.0	82.0	5.5	A+24.0	
KA 45-FB Male end, 150, pendular, complete	0450015053	Plastic	150.0	A+13.0	22.0	60.0	82.0	5.5	A+24.0	
KA 45-FB Female end, 175, complete	0450017550	Plastic	175.0	A+13.0	22.0	60.0	82.0	5.5	A+24.0	
KA 45-FB Female end, 175, pendular, complete	0450017552	Plastic	175.0	A+13.0	22.0	60.0	82.0	5.5	A+24.0	
KA 45-FB Male end, 175, complete	0450017551	Plastic	175.0	A+13.0	22.0	60.0	82.0	5.5	A+24.0	
KA 45-FB Male end, 175, pendular, complete	0450017553	Plastic	175.0	A+13.0	22.0	60.0	82.0	5.5	A+24.0	
KA 45-FG Female end, 050, complete	0450005054	Plastic	50.0	A+13.0	22.0	60.0	82.0	5.5	A+24.0	
KA 45-FG Female end, 050, pendular, complete	0450005056	Plastic	50.0	A+13.0	22.0	60.0	82.0	5.5	A+24.0	
KA 45-FG Male end, 050, complete	0450005055	Plastic	50.0	A+13.0	22.0	60.0	82.0	5.5	A+24.0	
KA 45-FG Male end, 050, pendular, complete	0450005057	Plastic	50.0	A+13.0	22.0	60.0	82.0	5.5	A+24.0	

**KA 45 CHAIN BRACKET FLEXIBLE**

Type	Order No.	Material	Inside width						Outside width of KA 0 mm
			A mm	E mm	F1 mm	G mm	G1 mm	H0 mm	
KA 45-FG Female end, 075, complete	0450007554	Plastic	75.0	A+13.0	22.0	60.0	82.0	5.5	A+24.0
KA 45-FG Female end, 075, pendular, complete	0450007556	Plastic	75.0	A+13.0	22.0	60.0	82.0	5.5	A+24.0
KA 45-FG Male end, 075, complete	0450007555	Plastic	75.0	A+13.0	22.0	60.0	82.0	5.5	A+24.0
KA 45-FG Male end, 075, pendular, complete	0450007557	Plastic	75.0	A+13.0	22.0	60.0	82.0	5.5	A+24.0
KA 45-FG Female end, 100, complete	0450010054	Plastic	100.0	A+13.0	22.0	60.0	82.0	5.5	A+24.0
KA 45-FG Female end, 100, pendular, complete	0450010056	Plastic	100.0	A+13.0	22.0	60.0	82.0	5.5	A+24.0
KA 45-FG Male end, 100, complete	0450010055	Plastic	100.0	A+13.0	22.0	60.0	82.0	5.5	A+24.0
KA 45-FG Male end, 100, pendular, complete	0450010057	Plastic	100.0	A+13.0	22.0	60.0	82.0	5.5	A+24.0
KA 45-FG Female end, 115, complete	0450011554	Plastic	115.0	A+13.0	22.0	60.0	82.0	5.5	A+24.0
KA 45-FG Female end, 115, pendular, complete	0450011556	Plastic	115.0	A+13.0	22.0	60.0	82.0	5.5	A+24.0
KA 45-FG Male end, 115, complete	0450011555	Plastic	115.0	A+13.0	22.0	60.0	82.0	5.5	A+24.0
KA 45-FG Male end, 115, pendular, complete	0450011557	Plastic	115.0	A+13.0	22.0	60.0	82.0	5.5	A+24.0
KA 45-FG Female end, 125, complete	0450012554	Plastic	125.0	A+13.0	22.0	60.0	82.0	5.5	A+24.0
KA 45-FG Female end, 125, pendular, complete	0450012556	Plastic	125.0	A+13.0	22.0	60.0	82.0	5.5	A+24.0
KA 45-FG Male end, 125, complete	0450012555	Plastic	125.0	A+13.0	22.0	60.0	82.0	5.5	A+24.0
KA 45-FG Male end, 125, pendular, complete	0450012557	Plastic	125.0	A+13.0	22.0	60.0	82.0	5.5	A+24.0
KA 45-FG Female end, 150, complete	0450015054	Plastic	150.0	A+13.0	22.0	60.0	82.0	5.5	A+24.0
KA 45-FG Female end, 150, pendular, complete	0450015056	Plastic	150.0	A+13.0	22.0	60.0	82.0	5.5	A+24.0
KA 45-FG Male end, 150, complete	0450015055	Plastic	150.0	A+13.0	22.0	60.0	82.0	5.5	A+24.0
KA 45-FG Male end, 150, pendular, complete	0450015057	Plastic	150.0	A+13.0	22.0	60.0	82.0	5.5	A+24.0
KA 45-FG Female end, 175, complete	0450017554	Plastic	175.0	A+13.0	22.0	60.0	82.0	5.5	A+24.0
KA 45-FG Female end, 175, pendular, complete	0450017556	Plastic	175.0	A+13.0	22.0	60.0	82.0	5.5	A+24.0
KA 45-FG Male end, 175, complete	0450017555	Plastic	175.0	A+13.0	22.0	60.0	82.0	5.5	A+24.0
KA 45-FG Male end, 175, pendular, complete	0450017557	Plastic	175.0	A+13.0	22.0	60.0	82.0	5.5	A+24.0

**TRT 45 DIVISIBLE SEPARATOR**

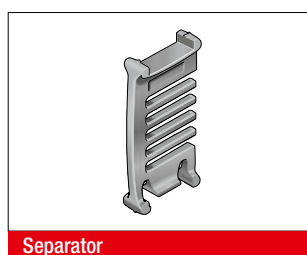
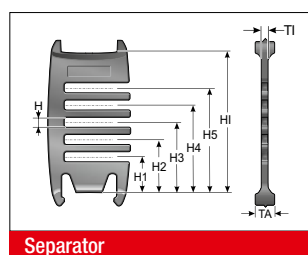

We recommend that separators be used if multiple round cables or conduits with differing diameters are to be installed.

Type	Order No.	Description	Version	Dimensions									
				T1 mm	TA mm	H mm	H1 mm	H2 mm	H3 mm	H4 mm	H5 mm	H1 mm	
TRT 45	045000009200	TRT 45, separator, divisible	lockable	3.0	8.0	3.2	11.3	16.9	22.5	28.1	33.7	45.0	



**TR 45-V SEPARATOR**

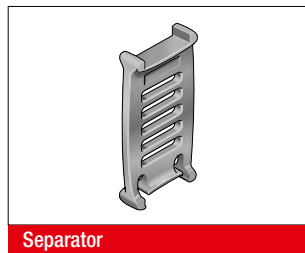
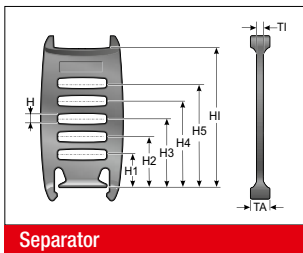

We recommend that separators be used if multiple round cables or conduits with differing diameters are to be installed.

Type	Order No.	Description	Version	TI mm	TA mm	H mm	H1 mm	H2 mm	H3 mm	H4 mm	H5 mm	HI mm
TR 45-V	045000009300	TR 45-V Separator	moveable	3.0	8.0	3.2	11.3	16.9	22.5	28.1	33.7	45.0

**RTT 45 SHELF SUPPORT, DIVISIBLE**

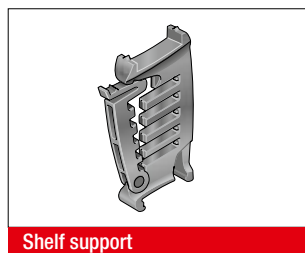
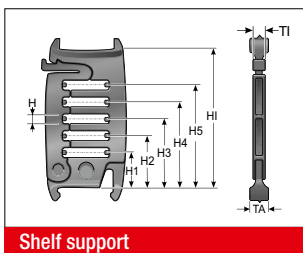

In connection with two separable shelf supports (RTT) with at least one end-to-end shelf (RB) the shelf becomes an easy to fill shelving system. The additional levels prevent cables from criss-crossing and minimise the friction between them.

Type	Order No.	Description	Version	TI mm	TA mm	H mm	H1 mm	H2 mm	H3 mm	H4 mm	H5 mm	HI mm
RTT 45	100090450000	Shelf support, divisible	lockable	5.0	8.0	3.2	11.3	16.9	22.5	28.1	33.7	45.0

**RB-3 SHELF**

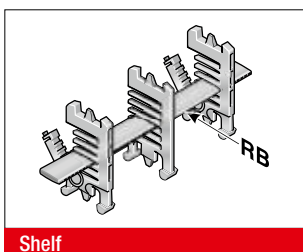

In connection with at least two separable shelf supports (RTT), the shelf becomes a shelving system. The additional levels prevent cables from criss-crossing and minimise the friction between them.

Type	Order No.	Description	Width mm	Inside width mm
RB 039-3	030100003900	Shelf	38.6	40.0
RB 041-3	1000004103	Shelf	41.1	50.0
RB 044-3	1000004403	Shelf	43.6	50.0
RB 046-3	1000004603	Shelf	46.1	50.0

**RB-3 SHELF**

Type	Order No.	Description	Width mm	Inside width mm
RB 049-3	030100004900	Shelf	48.6	50.0
RB 051-3	1000005103	Shelf	51.1	60.0
RB 054-3	1000005403	Shelf	53.6	60.0
RB 056-3	1000005603	Shelf	56.1	60.0
RB 059-3	030100005900	Shelf	58.6	60.0
RB 061-3	1000006103	Shelf	61.1	75.0
RB 064-3	1000006403	Shelf	63.6	75.0
RB 066-3	1000006603	Shelf	66.1	75.0
RB 069-3	1000006903	Shelf	68.6	75.0
RB 071-3	1000007103	Shelf	71.1	75.0
RB 074-3	030100007400	Shelf	73.6	75.0
RB 076-3	1000007603	Shelf	76.1	85.0
RB 079-3	1000007903	Shelf	78.6	85.0
RB 081-3	1000008103	Shelf	81.1	85.0
RB 084-3	030100008400	Shelf	83.6	85.0
RB 086-3	1000008603	Shelf	86.1	100.0
RB 089-3	1000008903	Shelf	88.6	100.0
RB 091-3	1000009103	Shelf	91.1	100.0
RB 094-3	1000009403	Shelf	93.6	100.0
RB 096-3	1000009603	Shelf	96.1	100.0
RB 099-3	030100009900	Shelf	98.6	100.0
RB 101-3	1000010103	Shelf	101.1	115.0
RB 104-3	1000010403	Shelf	103.6	115.0
RB 106-3	1000010603	Shelf	106.1	115.0
RB 109-3	1000010903	Shelf	108.6	115.0
RB 111-3	1000011103	Shelf	111.1	115.0
RB 114-3	030100011400	Shelf	113.6	115.0
RB 116-3	1000011603	Shelf	116.1	125.0
RB 119-3	1000011903	Shelf	118.6	125.0
RB 121-3	1000012103	Shelf	121.1	125.0
RB 124-3	030100012400	Shelf	123.6	125.0
RB 126-3	1000012603	Shelf	126.1	150.0
RB 129-3	1000012903	Shelf	128.6	150.0
RB 131-3	1000013103	Shelf	131.1	150.0
RB 134-3	1000013403	Shelf	133.6	150.0
RB 136-3	1000013603	Shelf	136.1	150.0
RB 139-3	1000013903	Shelf	138.6	150.0
RB 141-3	1000014103	Shelf	141.1	150.0
RB 144-3	1000014403	Shelf	143.6	150.0
RB 146-3	1000014603	Shelf	146.1	150.0
RB 149-3	030100014900	Shelf	148.6	150.0
RB 151-3	1000015103	Shelf	151.1	175.0
RB 154-3	1000015403	Shelf	153.6	175.0
RB 156-3	1000015603	Shelf	156.1	175.0
RB 159-3	1000015903	Shelf	158.6	175.0

**RB-3 SHELF**

Type	Order No.	Description	Width mm	Inside width mm
RB 161-3	1000016103	Shelf	161.1	175.0
RB 164-3	1000016403	Shelf	163.6	175.0
RB 166-3	1000016603	Shelf	166.1	175.0
RB 169-3	1000016903	Shelf	168.6	175.0
RB 174-3	030100017400	Shelf	173.6	175.0
RB 176-3	1000017603	Shelf	176.1	200.0
RB 179-3	1000017903	Shelf	178.6	200.0
RB 181-3	1000018103	Shelf	181.1	200.0
RB 184-3	1000018403	Shelf	183.6	200.0
RB 186-3	1000018603	Shelf	186.1	200.0
RB 189-3	1000018903	Shelf	188.6	200.0
RB 191-3	1000019103	Shelf	191.1	200.0
RB 194-3	1000019403	Shelf	193.6	200.0
RB 196-3	1000019603	Shelf	196.1	200.0
RB 199-3	030100019900	Shelf	198.6	200.0

**RS-ZL-3 ZLA MP 45 CROSSBAR STRAIN RELIEF PLATE**

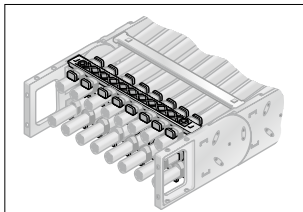

Crossbar strain relief plate

Fixed integrated frame bridge strain relief plates in the chain brackets. Tailored to all crossbar widths up to 175 mm. May be assembled on the inside and outside bends at both chain endings.

Type	Order No.	Description	Inside width mm
RS-ZL 050-3 ZLA MP 45	0451050010	Crossbar strain relief plate	50.0
RS-ZL 075-3 ZLA MP 45	0451075010	Crossbar strain relief plate	75.0
RS-ZL 100-3 ZLA MP 45	0451100010	Crossbar strain relief plate	100.0
RS-ZL 115-3 ZLA MP 45	0451115010	Crossbar strain relief plate	115.0
RS-ZL 125-3 ZLA MP 45	0451125010	Crossbar strain relief plate	125.0
RS-ZL 150-3 ZLA MP 45	0451150010	Crossbar strain relief plate	150.0
RS-ZL 175-3 ZLA MP 45	0451175010	Crossbar strain relief plate	175.0

**STRAIN RELIEF WITH STEEL FIX**

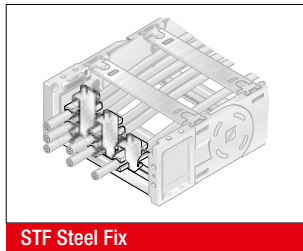
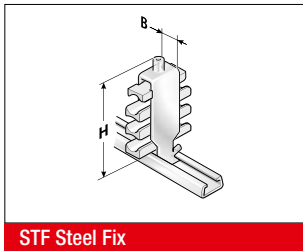

C-rails (galvanised) for permanent integration, for accommodating the Steel Fix bow clamps in the chain brackets. The bow clamps can take up to 3 cables and are suitable for C-rails with a groove width of 11 mm. Due to the design of the trough elements, a cable preserving cable guidance is ensured. May be assembled on the inside and outside bends at both chain endings. The overall height stated is a guide only. The actual height is, amongst other things, dependent on the diameter and the quality of the cable. A safety distance of 10 mm at the fixed point above the strain relief must be kept during gliding applications.

Type	Order No.	Description	Seats qty.	Cable Ø mm	Width mm	Total height (H) mm
<b>Single clamp (for one cable)</b>						
STF 12-1 Steel Fix	81661801	Hooped clamp	1	6.0 – 12.0	16.0	55.0
STF 14-1 Steel Fix	81661802	Hooped clamp	1	12.0 – 14.0	18.0	52.0
STF 16-1 Steel Fix	81661803	Hooped clamp	1	14.0 – 16.0	20.0	54.0
STF 18-1 Steel Fix	81661804	Hooped clamp	1	16.0 – 18.0	22.0	56.0
STF 20-1 Steel Fix	81661805	Hooped clamp	1	18.0 – 20.0	24.0	59.0
STF 22-1 Steel Fix	81661806	Hooped clamp	1	20.0 – 22.0	26.0	61.0
STF 26-1 Steel Fix	81661807	Hooped clamp	1	22.0 – 26.0	30.0	70.0
STF 30-1 Steel Fix	81661808	Hooped clamp	1	26.0 – 30.0	34.0	74.0
STF 34-1 Steel Fix	81661809	Hooped clamp	1	30.0 – 34.0	38.0	78.0
STF 38-1 Steel Fix	81661810	Hooped clamp	1	34.0 – 38.0	42.0	82.0
STF 42-1 Steel Fix	81661811	Hooped clamp	1	38.0 – 42.0	46.0	91.0
<b>Double clamp (for two cables)</b>						
STF 12-2 Steel Fix	81661821	Hooped clamp	2	6.0 – 12.0	16.0	73.0
STF 14-2 Steel Fix	81661822	Hooped clamp	2	12.0 – 14.0	18.0	74.0
STF 16-2 Steel Fix	81661823	Hooped clamp	2	14.0 – 16.0	20.0	82.0
STF 18-2 Steel Fix	81661824	Hooped clamp	2	16.0 – 18.0	22.0	86.0
STF 20-2 Steel Fix	81661825	Hooped clamp	2	18.0 – 20.0	24.0	91.0
STF 22-2 Steel Fix	81661826	Hooped clamp	2	20.0 – 22.0	26.0	95.0
STF 26-2 Steel Fix	81661827	Hooped clamp	2	22.0 – 26.0	30.0	108.0
STF 30-2 Steel Fix	81661828	Hooped clamp	2	26.0 – 30.0	34.0	121.0
STF 34-2 Steel Fix	81661829	Hooped clamp	2	30.0 – 34.0	38.0	129.0
<b>Triple clamp (for three cables)</b>						
STF 12-3 Steel Fix	81661841	Hooped clamp	3	6.0 – 12.0	16.0	98.0
STF 14-3 Steel Fix	81661842	Hooped clamp	3	12.0 – 14.0	18.0	98.0
STF 16-3 Steel Fix	81661843	Hooped clamp	3	14.0 – 16.0	20.0	105.0
STF 18-3 Steel Fix	81661844	Hooped clamp	3	16.0 – 18.0	22.0	111.0
STF 20-3 Steel Fix	81661845	Hooped clamp	3	18.0 – 20.0	24.0	118.0
STF 22-3 Steel Fix	81661846	Hooped clamp	3	20.0 – 22.0	26.0	130.0

**GUIDE CHANNEL VAW (ALUMINIUM / STAINLESS STEEL)**



A range of variable guide channel systems, constructed from aluminium or stainless steel sections, are available for this energy chain.

The variable guide channel ensures that the energy chain is supported and guided securely.

**MP 45 LOWERED FIXING POINT**

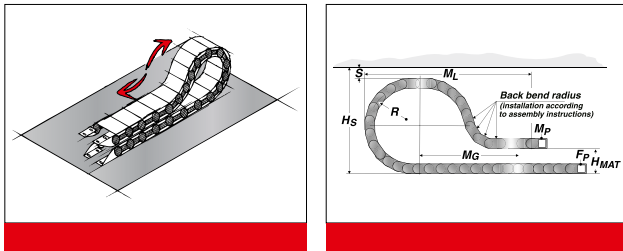

It is sometimes necessary to lower the height of the moving attachment point.

In such cases, modifications to the chain layout should be noted (e.g. extension of chain).

Please contact our application engineers.

Radius R mm	Height of moving end bracket (H <sub>MA</sub> ) mm	Safety margin (S) mm	Installation height incl. safety (H <sub>S</sub> ) mm	Projection (M <sub>L</sub> ) mm	Additional links qty.	of which additional back chain links qty.
150.0	200.0	50.0	412.0	630.0	12	3
200.0	200.0	50.0	512.0	760.0	13	3
250.0	200.0	50.0	612.0	930.0	18	4
300.0	200.0	50.0	712.0	1080.0	20	4

**ASSEMBLY**

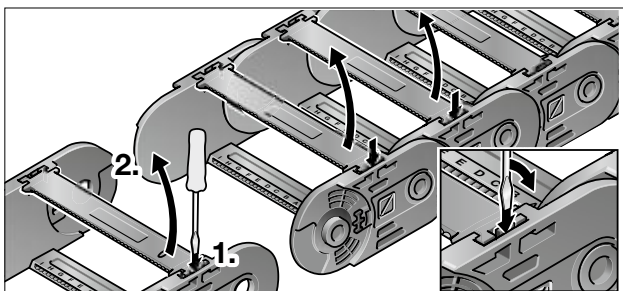

Step 1

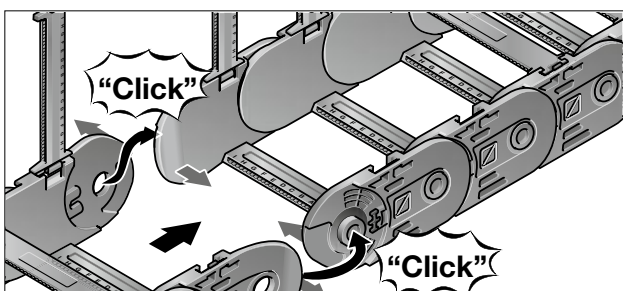

Step 2

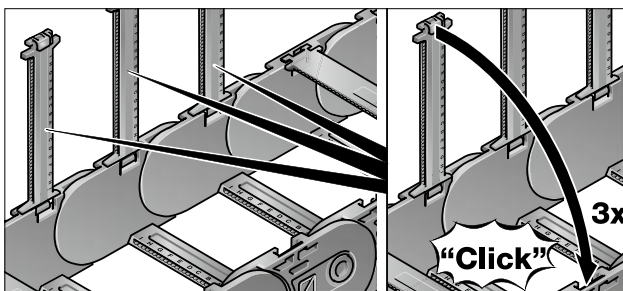

Step 3

**DISASSEMBLY**

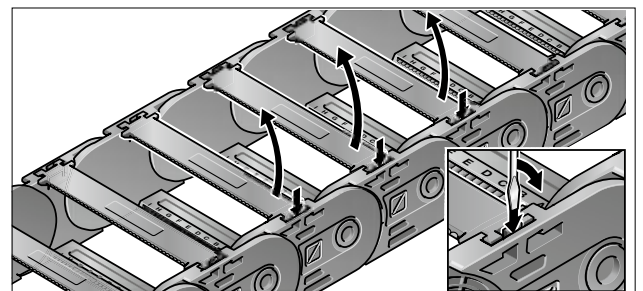

Step 1

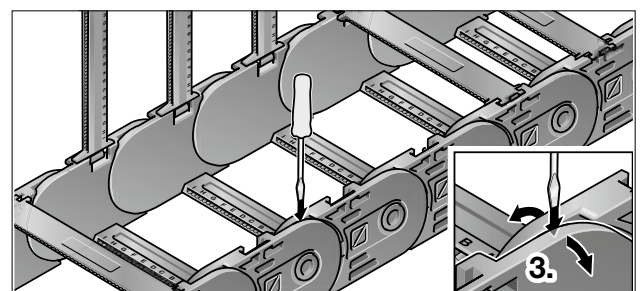

Step 2

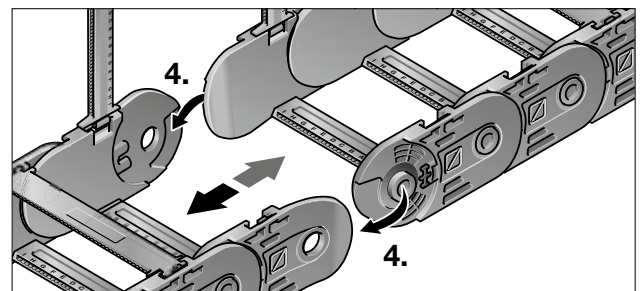

Step 3

## MP 65G

CLOSED



- PLASTIC VARIANT
- METAL CHAIN BRACKET
- OPENS ON INSIDE AND OUTSIDE BEND

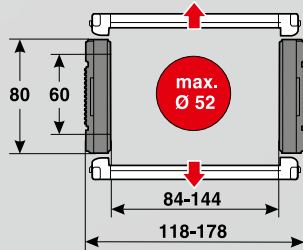

### TECHNICAL DATA

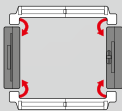

**Loading side**  
Inside and outside bend

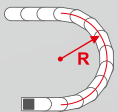

**Available radii**  
200.0 – 400.0 mm

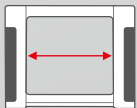

**Available interior widths**  
with plastic cover  
84.0 – 144.0 mm

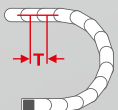

**Pitch**  
T = 91.5 mm

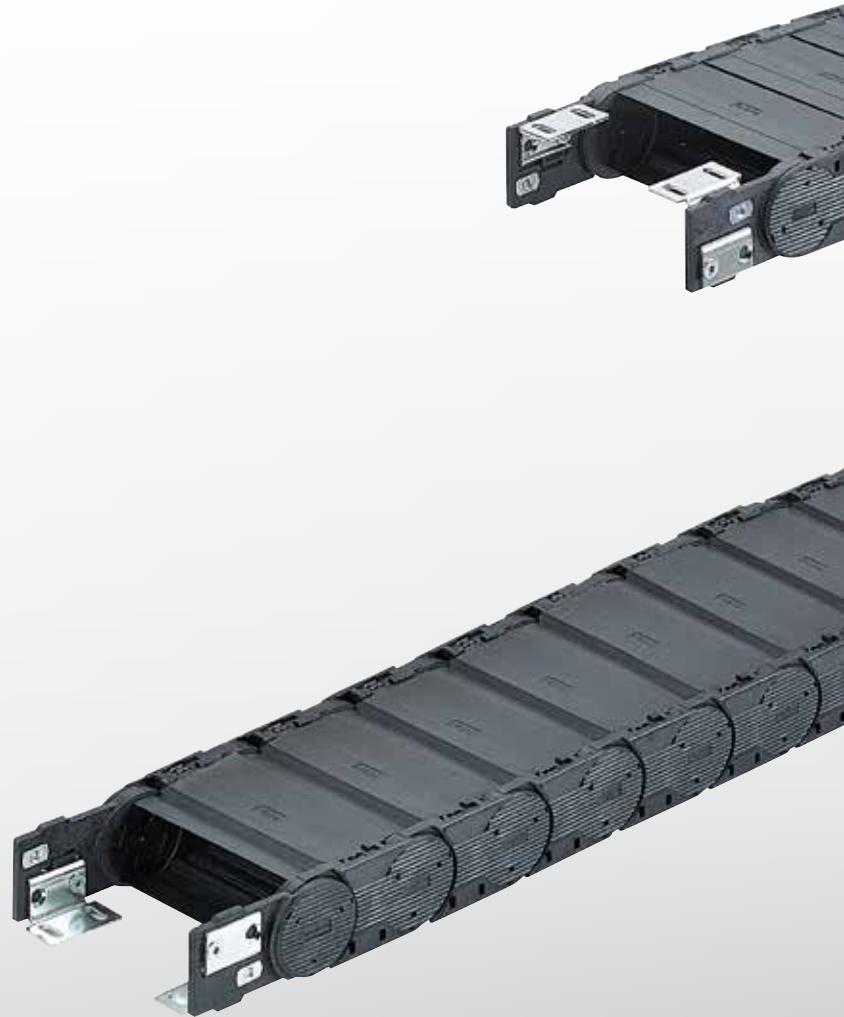



## TECHNICAL SPECIFICATIONS

Travel distance gliding $L_g$ max.	60.0 m
Travel distance self-supporting $L_s$ max.	see diagram on page 157
Travel distance vertical, hanging $L_{vh}$ max.	50.0 m
Travel distance vertical, upright $L_{vs}$ max.	5.0 m
Rotated 90°, unsupported $L_{90f}$ max.	2.0 m
Speed, gliding $V_g$ max.	5.0 m/s
Speed, self-supporting $V_s$ max.	15.0 m/s
Acceleration, gliding $a_g$ max.	15.0 m/s <sup>2</sup>
Acceleration, self-supporting $a_s$ max.	20.0 m/s <sup>2</sup>

Contact our engineering department to meet any higher requirements: [efk@murrplastik.de](mailto:efk@murrplastik.de)

## MATERIAL PROPERTIES

Standard material	Polyamide (PA) black
Service temperature	-30.0 – 120.0 °C
Gliding friction factor	0.3
Static friction factor	0.45
Fire classification	Based on UL 94 HB

Other material properties on request.

## CHAIN BRACKET

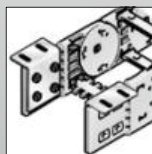

Chain bracket angle

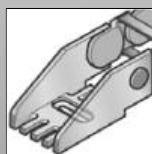

Chain bracket U-part

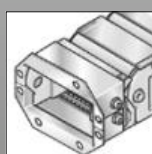

End brackets flange

## SHELVING SYSTEM

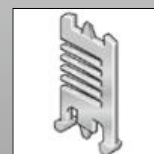

Separator TR

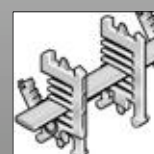

RS shelving system

## GUIDE CHANNELS

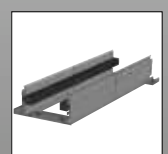

VAW aluminium

**ORDERING KEY**

Dimensions in mm [US inch]

Type code	Variation	Inside width	Outside width	Inside width	Outside width	Radius	Crossbar variant	Material	Chain length
<b>0650 44</b>	Cover on outside bend Cover on inside bend Opens on inside and outside bend	<b>084</b> [3.31]	<b>118</b> [4.65]			<b>200</b> [7.87]	<b>0</b> Plastic, full-ridged with bias	<b>0</b> Polyamide standard (PA/black)	
		<b>105</b> [4.13]	<b>139</b> [5.47]						
		<b>144</b> [5.67]	<b>178</b> [7.01]						
						<b>240</b> [9.45]	<b>1</b> Plastic, full-ridged without bias	<b>9</b> Special version (on request)	
						<b>280</b> [11.02]	<b>9</b> Special version (on request)		
						<b>350</b> [13.78]			
						<b>400</b> [15.75]			

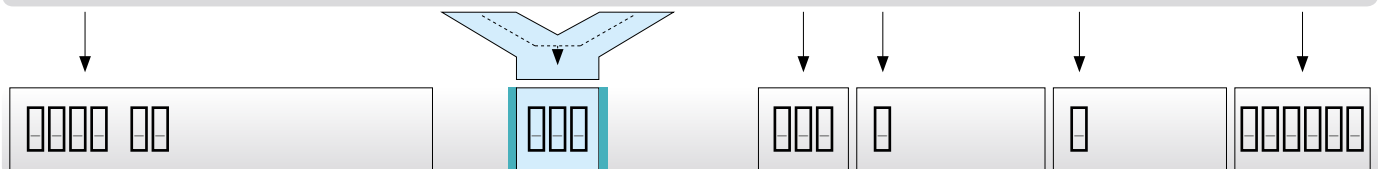

**Ordering example: 0650 44 084 200 0 0 1556**

Cover on outside bend, cover on inside bend, openable from inside and outside bend  
 Inside width 84 mm, radius 200 mm  
 Plastic crossbar, full-ridged with bias, material black-coloured polyamide  
 Chain length 1556 mm (17 links)



**SELF-SUPPORTING LENGTH**

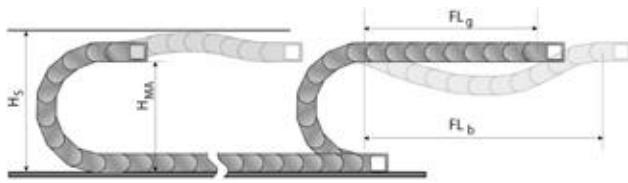

The self-supporting length is the distance between the chain bracket on the moving end and the start of the chain arch. The installation variant  $FL_g$  offers the lowest load and wear for the energy chain.

The maximum travel parameters (speed and acceleration) can be applied for this variant.

- $H_S$  = Installation height plus safety
- $H_{MA}$  = Height of moving end connection
- $FL_g$  = Self-supporting length, upper run straight
- $FL_b$  = Self-supporting length, upper run bent

**LOAD DIAGRAM FOR SELF-SUPPORTING APPLICATIONS**

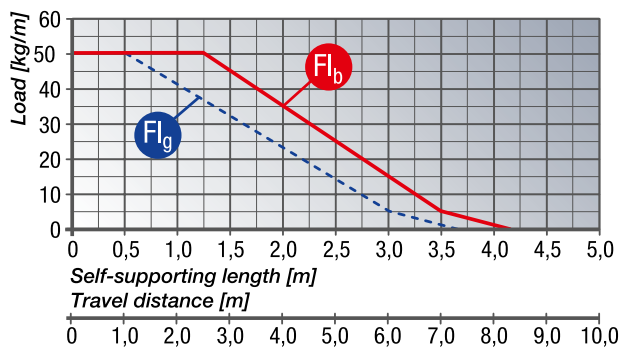

**$FL_g$  Self-supporting length, upper run straight**

In the  $FL_g$  range, the chain upper run still has a bias, is straight or has a maximum sag of 60.0 mm.

**$FL_b$  Self-supporting length, upper run bent**

In the  $FL_b$  range, the chain upper run has a sag of more than 60.0 mm, but this is still less than the maximum sag. Where the sag is greater than that permitted in the  $FL_b$  range, the application is critical and should be avoided. The self-supporting length can be optimised by using a support for the upper run or a more stable energy chain.

**DETERMINING THE CHAIN LENGTH**

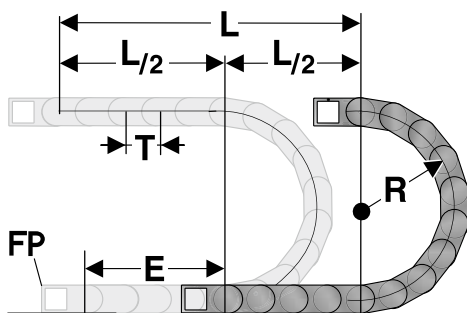

The fixed point of the energy chain should be connected in the middle of the travel distance.

This arrangement gives the shortest connection between the fixed point (FP) and the moving consumer and thus the most efficient chain length.

Chain length calculation =  $L/2 + \pi * R + E$   
 $\approx 1 \text{ m chain} = 11 \text{ qty. } \times 91.5 \text{ mm.}$

- E = Distance between entry point and middle of travel distance
- L = Travel distance
- R = Radius
- P = Pitch 91.5 mm

**INSTALLATION DIMENSIONS**

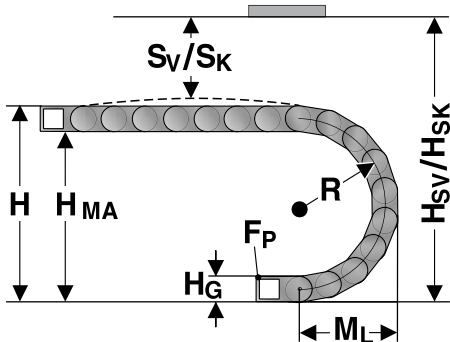

The moving end chain connection is to be screw fixed at height  $H_{MA}$  for the respective radius.

Concerning the installed dimensions, you must take into account whether the chain links are equipped with or without bias.

For chain links without bias, the “Installed height without bias  $H_{SK}$ ” value has to be taken into account.

If the chain links are equipped with a bias, the value “Installed height with bias  $H_{SV}$ ” has to be taken into account.

Radius R	200	240	280	350	400
Outside height of chain link ( $H_G$ )	80	80	80	80	80
Height of bend (H)	480	560	640	780	880
Height of moving end bracket ( $H_{MA}$ )	400	480	560	700	800
Safety margin with bias ( $S_v$ )	50	50	50	50	50
Installation height with bias ( $H_{sv}$ )	530	610	690	830	930
Safety margin without bias ( $S_k$ )	15	15	15	15	15
Installation height without bias ( $H_{sk}$ )	495	575	655	795	895
Arc projection ( $M_L$ )	332	372	412	482	532

**KA 66 CHAIN BRACKET ANGLE**

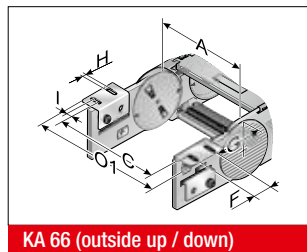
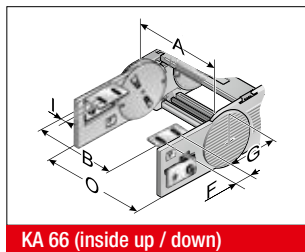

There are several options regarding the chain bracket. The fixed-point bracket (inside/bottom) and the moving end bracket (inside/top) are supplied as standard. However, any other combination can be supplied upon request. The chain bracket is fastened at the end like a side link. This enables the chain to move right up to the bracket. Each chain requires two chain brackets. The brackets should be fastened with M8 screws.

Type	Order No.	Material	Inside width							Outside width of KA 0	Outside width of KA 01	
			A mm	B mm	C mm	F mm	G mm	G1 mm	HØ mm			I mm
KA 66	0660000050	Sheet steel	62.0 – 182.0	A-17.0	A+51.0	45.0	50.5	86.0	9.0	10.0	A+34.0	A+64.0
KA 66	0660000060	Stainless steel 1.4301	62.0 – 182.0	A-17.0	A+51.0	45.0	50.5	86.0	9.0	10.0	A+34.0	A+64.0

**KA 66 CHAIN BRACKET U-PART**

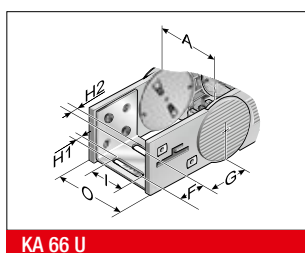

The chain bracket is an all-plastic part. The bracket is precisely adjusted to the respective chain width and only needs to be snapped in at the chain link. Please order one male and one female end bracket for each chain. The brackets should be fastened with M5 screws. The cables or conduits may be fastened with cable ties on the integrated strain relief of the chain bracket.

Type	Order No.	Material	Inside width					Outside width of KA 0	
			A mm	F mm	G mm	H1 mm	H2 mm		I mm
KA 66 U	0660000054	Sheet steel	45.0	28.0	58.5	6.5	8.5	33.0	A+34.0

**KA 65 G END BRACKETS FLANGE**

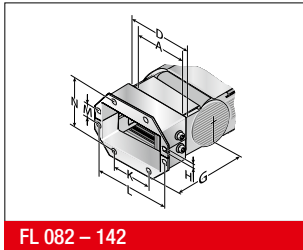

An energy chain requires two chain brackets. The divisible flange connection has been specifically designed for commissioning and re-installation. This keeps the chain in the installed position.

FL 082 – 142

Type	Order No.	Material	Inside width						
			A mm	G mm	HØ mm	K mm	L mm	M mm	N mm
FL 082	0650000070	Sheet steel	86.0	136.0	7.0	78.0	141.5	40.0	105.0
FL 107	0650000072	Sheet steel	102.0	136.0	7.0	100.0	163.5	40.0	105.0
FL 142	0650000074	Sheet steel	125.0	136.0	7.0	138.0	201.5	40.0	105.0
FL 082	0650000080	Stainless steel 1.4301	86.0	136.0	7.0	78.0	141.5	40.0	105.0
FL 107	0650000082	Stainless steel 1.4301	102.0	136.0	7.0	100.0	163.5	40.0	105.0
FL 142	0650000084	Stainless steel 1.4301	125.0	136.0	7.0	138.0	201.5	40.0	105.0

**TR 66 SEPARATOR**

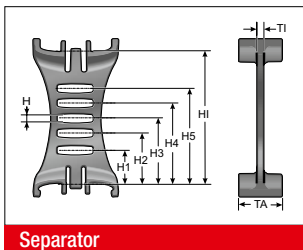

Separator

We recommend that separators be used if multiple round cables or conduits with differing diameters are to be installed.

Type	Order No.	Description	Version	TI mm	TA mm	H mm	H1 mm	H2 mm	H3 mm	H4 mm	H5 mm	H6 mm
TV 66	066000009000	Separator	lockable	3.5	20.0	4.4	15.8	22.9	30.0	37.1	44.2	60.0

**MP 66 SHELVING SYSTEM**

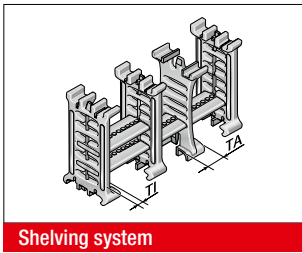

Shelving system

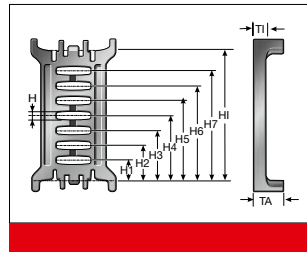

The shelf must be used with a minimum of two shelf supports to create a shelving system. The additional levels prevent cables from criss-crossing and minimise the friction between them. The shelving system may be preassembled on request.

Type	Order No.	Description	Width mm	Clearance width mm	Pitch mm	TI mm	H1 mm	H2 mm	H3 mm	H4 mm	H5 mm	H6 mm	H7 mm
RB 031	100000003100	Shelf	42.0	31.0	1.6								
RB 048	100000004800	Shelf	59.0	48.0	1.6								
RB 070	100000007000	Shelf	81.0	70.0	1.6								
RB 092	100000009200	Shelf	103.0	92.0	1.6								
RB 100	100000010000	Shelf	111.0	100.0	1.6								
RB 128	100000012800	Shelf	139.0	128.0	1.6								
RB 167	100000016700	Shelf	178.0	167.0	1.6								
RT 66	1000900100	Shelf support	4.3		1.6	6.5	8.7	15.8	22.9	30.0	37.1	44.2	51.3

**MP 66 REARWARD RADII**

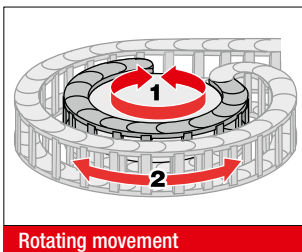

Rotating movement

Side links with rearward radius allow movements in both directions. This is intended for rotating movements and lowered chain brackets. Rotation movements are only possible with open variants.

Type	Order No.	Rearward radius mm	Version
SR 66 (RÜ240)	066000000060	240.0	Available for radii 150, 200, 240, 280 and 350 mm

**GUIDE CHANNEL VAW (ALUMINIUM)**



VAW aluminium

A variable guide channel system, constructed from aluminium sections, is available for this energy chain. The variable guide channel ensures that the energy chain is supported and guided securely.

ASSEMBLY

DISASSEMBLY

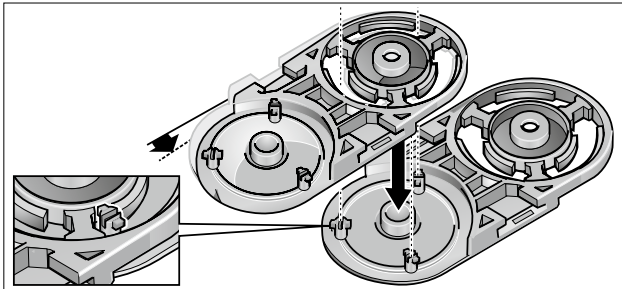

Step 1

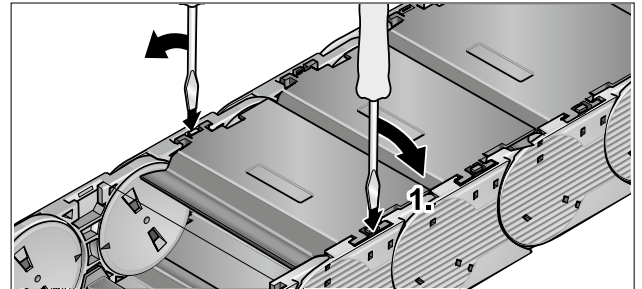

Step 1

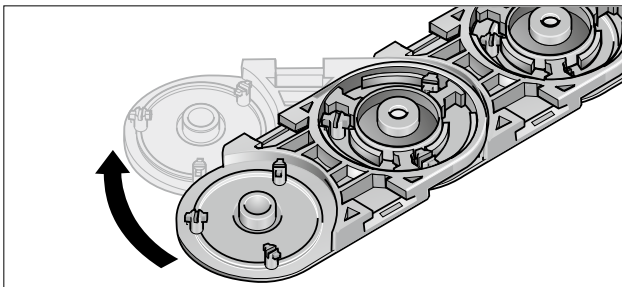

Step 2

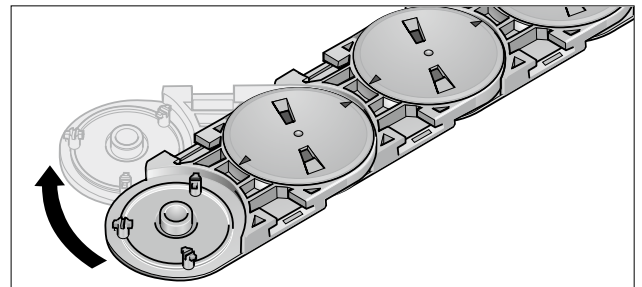

Step 2

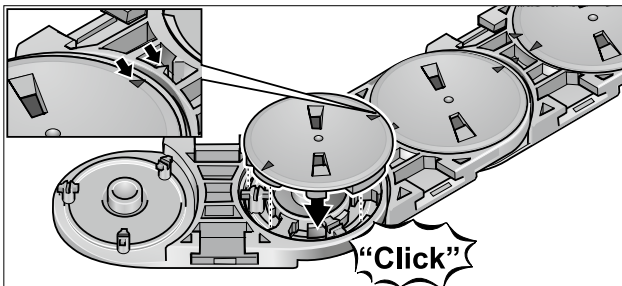

Step 3

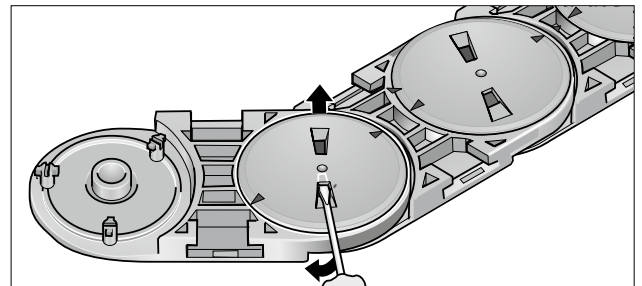

Step 3

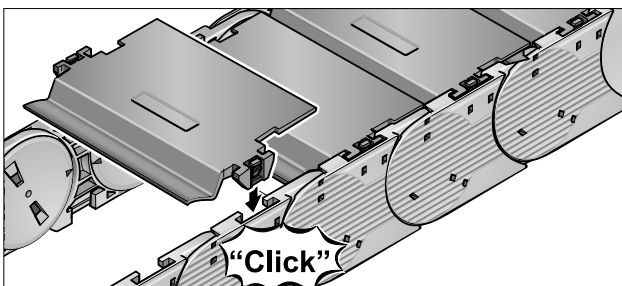

Step 4

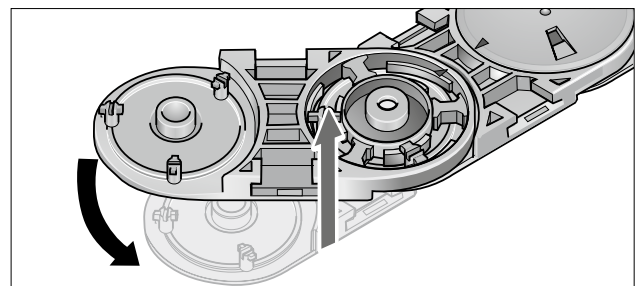

Step 4

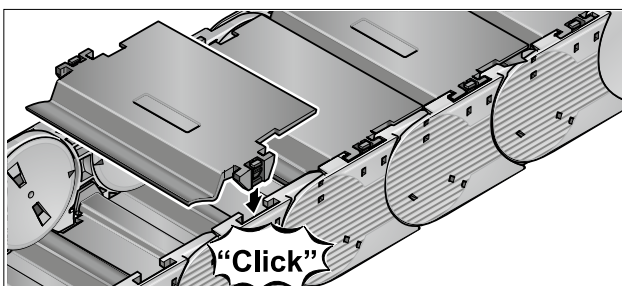

Step 5

**MP 25.1/.2**  
OPEN



**MP 25.3/.4**  
CLOSED



- BROAD INTERIOR LAYOUT
- BRUSH SUPPORT
- CHAIN BRACKET WITH INTEGRATED STRAIN RELIEF
- SUITABLE FOR UNIVERSAL USE

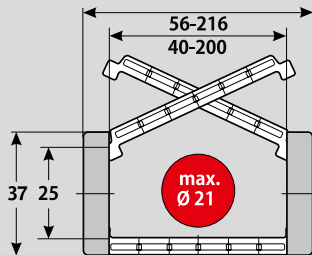

## TECHNICAL DATA

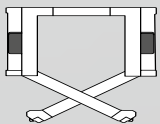

**Loading side**  
Inside or outside bend

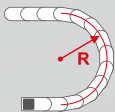

**Available radii**  
50.0 – 300.0 mm

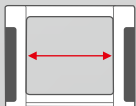

**Available interior widths**  
With plastic crossbar  
40.0 – 200.0 mm

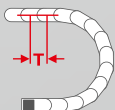

**Pitch**  
T = 45.0 mm

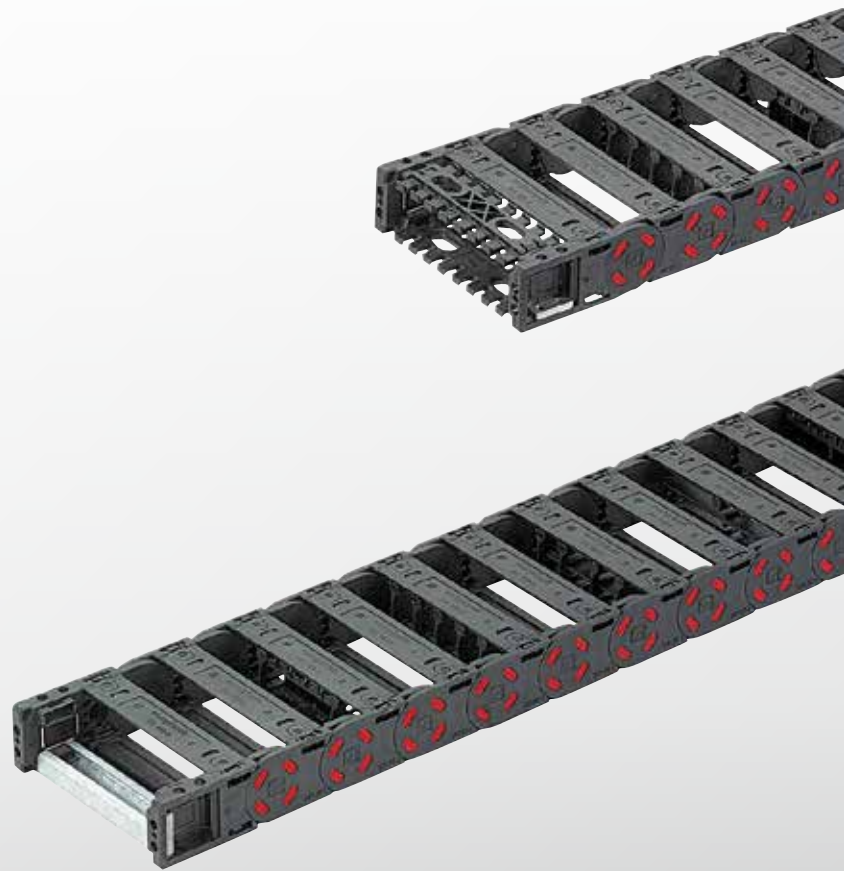

## TECHNICAL SPECIFICATIONS

Travel distance gliding $L_g$ max.	35.0 m
Travel distance self-supporting $L_s$ max.	see diagram on page 165
Travel distance vertical, hanging $L_{vh}$ max.	25.0 m
Travel distance vertical, upright $L_{vs}$ max.	3.0 m
Rotated 90°, unsupported $L_{90f}$ max.	0.7 m
Speed, gliding $V_g$ max.	3.0 m/s
Speed, self-supporting $V_f$ max.	10.0 m/s
Acceleration, gliding $a_g$ max.	10.0 m/s <sup>2</sup>
Acceleration, self-supporting $a_s$ max.	15.0 m/s <sup>2</sup>

Contact our engineering department to meet any higher requirements: [efk@murrplastik.de](mailto:efk@murrplastik.de)



## MATERIAL PROPERTIES

Standard material	Polyamide (PA) black
Service temperature	-30.0 – 120.0 °C
Gliding friction factor	0.3
Static friction factor	0.45
Fire classification	UL 94 HB

Other material properties on request.

### CHAIN BRACKET

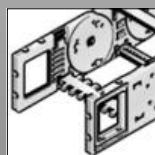

Chain bracket flexible

### SHELVING SYSTEM



Separator TR

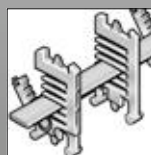

RS shelving system

### GUIDE CHANNELS



VAW steel galvanised / stainless steel

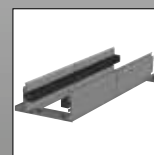

VAW aluminium

### STRAIN RELIEF

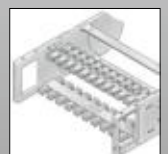

RS-ZL crossbar strain relief



STF Steel Fix

**ORDERING KEY**

Dimensions in mm [US inch]

Type code	Variation	Inside width	Outside width	Inside width	Outside width	Radius	Crossbar variant	Material	Chain length																																																																																												
0025 01	Crossbar on outside bend Crossbar on inside bend Opens on outside bend	040 [1.57]	056 [2.20]			050 <sup>1)</sup> [1.97]	0 Plastic, full-ridged with bias	0 Polyamide standard (PA/black)																																																																																													
		050 [1.97]	066 [2.60]							0025 02	Crossbar on outside bend Crossbar on inside bend Opens on inside bend	060 [2.36]	076 [2.99]			075 <sup>1)</sup> [2.95]	1 Plastic, full-ridged without bias	7 EMC (PA/light grey)		075 [2.95]	091 [3.58]			0025 03	Cover on outside bend Cover on inside bend Opens on outside bend	085 [3.35]	101 [3.98]			100 [3.94]		9 Special version (on request)		100 [3.94]	116 [4.57]			0025 04	Cover on outside bend Cover on inside bend Opens on inside bend	125 [4.92]	141 [5.55]			125 [4.92]				150 [5.91]	166 [6.54]			0025 05	Cover on outside bend Crossbar on inside bend Opens on outside bend	200 [7.87]	216 [8.50]			150 [5.91]								0025 06	Cover on outside bend Crossbar on inside bend Opens on inside bend					200 [7.87]								0025 07	Crossbar on outside bend Cover on inside bend Opens on outside bend					250 [9.84]								0025 08	Crossbar on outside bend Cover on inside bend Opens on inside bend					300 [11.81]	
0025 02	Crossbar on outside bend Crossbar on inside bend Opens on inside bend	060 [2.36]	076 [2.99]			075 <sup>1)</sup> [2.95]	1 Plastic, full-ridged without bias	7 EMC (PA/light grey)																																																																																													
		075 [2.95]	091 [3.58]							0025 03	Cover on outside bend Cover on inside bend Opens on outside bend	085 [3.35]	101 [3.98]			100 [3.94]		9 Special version (on request)		100 [3.94]	116 [4.57]			0025 04	Cover on outside bend Cover on inside bend Opens on inside bend	125 [4.92]	141 [5.55]			125 [4.92]				150 [5.91]	166 [6.54]			0025 05	Cover on outside bend Crossbar on inside bend Opens on outside bend	200 [7.87]	216 [8.50]			150 [5.91]								0025 06	Cover on outside bend Crossbar on inside bend Opens on inside bend					200 [7.87]								0025 07	Crossbar on outside bend Cover on inside bend Opens on outside bend					250 [9.84]								0025 08	Crossbar on outside bend Cover on inside bend Opens on inside bend					300 [11.81]															
0025 03	Cover on outside bend Cover on inside bend Opens on outside bend	085 [3.35]	101 [3.98]			100 [3.94]		9 Special version (on request)																																																																																													
		100 [3.94]	116 [4.57]							0025 04	Cover on outside bend Cover on inside bend Opens on inside bend	125 [4.92]	141 [5.55]			125 [4.92]				150 [5.91]	166 [6.54]			0025 05	Cover on outside bend Crossbar on inside bend Opens on outside bend	200 [7.87]	216 [8.50]			150 [5.91]								0025 06	Cover on outside bend Crossbar on inside bend Opens on inside bend					200 [7.87]								0025 07	Crossbar on outside bend Cover on inside bend Opens on outside bend					250 [9.84]								0025 08	Crossbar on outside bend Cover on inside bend Opens on inside bend					300 [11.81]																													
0025 04	Cover on outside bend Cover on inside bend Opens on inside bend	125 [4.92]	141 [5.55]			125 [4.92]																																																																																															
		150 [5.91]	166 [6.54]							0025 05	Cover on outside bend Crossbar on inside bend Opens on outside bend	200 [7.87]	216 [8.50]			150 [5.91]								0025 06	Cover on outside bend Crossbar on inside bend Opens on inside bend					200 [7.87]								0025 07	Crossbar on outside bend Cover on inside bend Opens on outside bend					250 [9.84]								0025 08	Crossbar on outside bend Cover on inside bend Opens on inside bend					300 [11.81]																																											
0025 05	Cover on outside bend Crossbar on inside bend Opens on outside bend	200 [7.87]	216 [8.50]			150 [5.91]																																																																																															
										0025 06	Cover on outside bend Crossbar on inside bend Opens on inside bend					200 [7.87]								0025 07	Crossbar on outside bend Cover on inside bend Opens on outside bend					250 [9.84]								0025 08	Crossbar on outside bend Cover on inside bend Opens on inside bend					300 [11.81]																																																									
0025 06	Cover on outside bend Crossbar on inside bend Opens on inside bend					200 [7.87]																																																																																															
										0025 07	Crossbar on outside bend Cover on inside bend Opens on outside bend					250 [9.84]								0025 08	Crossbar on outside bend Cover on inside bend Opens on inside bend					300 [11.81]																																																																							
0025 07	Crossbar on outside bend Cover on inside bend Opens on outside bend					250 [9.84]																																																																																															
										0025 08	Crossbar on outside bend Cover on inside bend Opens on inside bend					300 [11.81]																																																																																					
0025 08	Crossbar on outside bend Cover on inside bend Opens on inside bend					300 [11.81]																																																																																															



**ORDERING EXAMPLE: 0025 01 040 050 0 0 1125**

Crossbar on outside bend, crossbar on inside bend, can be opened from outside bend  
 Inside width 40 mm; radius 50 mm  
 Plastic crossbar, full-ridged with bias, material black-coloured polyamide  
 Chain length 1125 mm (25 links)

<sup>1)</sup> only for Version 01 and 02



**SELF-SUPPORTING LENGTH**

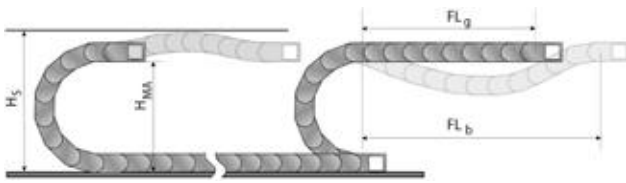

The self-supporting length is the distance between the chain bracket on the moving end and the start of the chain arch. The installation variant  $FL_g$  offers the lowest load and wear for the energy chain. The maximum travel parameters (speed and acceleration) can be applied for this variant.

- $H_s$  = Installation height plus safety
- $H_{MA}$  = Height of moving end connection
- $FL_g$  = Self-supporting length, upper run straight
- $FL_b$  = Self-supporting length, upper run bent

**LOAD DIAGRAM FOR SELF-SUPPORTING APPLICATIONS**

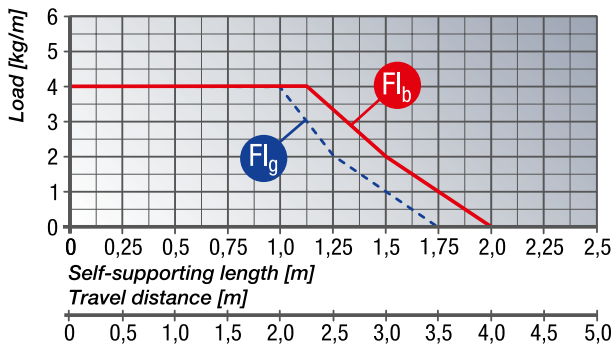

**$FL_g$  Self-supporting length, upper run straight**  
 In the  $FL_g$  range, the chain upper run still has a bias, is straight or has a maximum sag of 60.0 mm.

**$FL_b$  Self-supporting length, upper run bent**  
 In the  $FL_b$  range, the chain upper run has a sag of more than 60.0 mm, but this is still less than the maximum sag. Where the sag is greater than that permitted in the  $FL_b$  range, the application is critical and should be avoided. The self-supporting length can be optimised by using a support for the upper run or a more stable energy chain. Closed energy chains (with covers) have a higher unit weight than open chains (with crossbars). This higher weight must be taken into account when calculating the self-supporting length. To the weight of the cabling (cable load, in kg/m), you must add 0.3 kg/m, to account for the higher weight of closed-cover chains.

**DETERMINING THE CHAIN LENGTH**

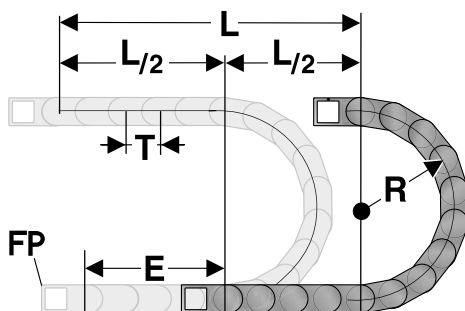

The fixed point of the energy chain should be connected in the middle of the travel distance. This arrangement gives the shortest connection between the fixed point (FP) and the moving consumer and thus the most efficient chain length.

Chain length calculation =  $L/2 + \pi * R + E$   
 $\approx 1 \text{ m chain} = 22 \text{ qty. } \times 45.0 \text{ mm.}$

- E = Distance between entry point and middle of travel distance
- L = Travel distance
- R = Radius
- P = Pitch 45.0 mm

**INSTALLATION DIMENSIONS**

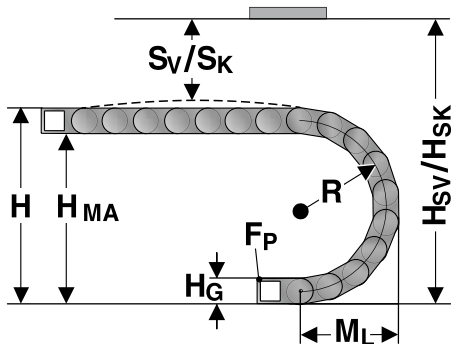

The moving end chain connection is to be screw fixed at height  $H_{MA}$  for the respective radius.

Concerning the installed dimensions, you must take into account whether the chain links are equipped with or without bias.

For chain links without bias, the “Installed height without bias  $H_{SK}$ ” value has to be taken into account.

If the chain links are equipped with a bias, the value “Installed height with bias  $H_{SV}$ ” has to be taken into account.

Radius R	50	75	100	125	150	200	250	300
Outside height of chain link ( $H_G$ )	37	37	37	37	37	37	37	37
Height of bend (H)	157	207	257	307	357	457	557	657
Height of moving end bracket ( $H_{MA}$ )	120	170	220	270	320	420	520	620
Safety margin with bias ( $S_V$ )	38	38	38	38	38	38	38	38
Installation height with bias ( $H_{SV}$ )	195	245	295	345	395	495	595	695
Safety margin without bias ( $S_K$ )	18	18	18	18	18	18	18	18
Installation height without bias ( $H_{SK}$ )	175	225	275	325	375	475	575	675
Arc projection ( $M_L$ )	124	149	174	199	224	274	324	374

**EB 25/30 INSERT PANEL**

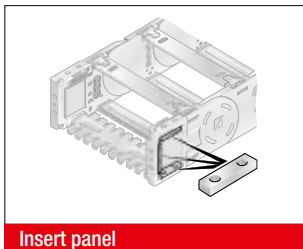

To fix the chain connection, the insert panels can be inserted above, below or on the side and are available with threads or through-holes.

Type	Order No.	Description	Holes mm	Thread
EB 25/30-FG V2A	030100005502	Insert panel with thread		M5x0,8
EB 25/30-FB V2A	030100005500	Insert panel with through-hole	5.5	

**KA 25 CHAIN BRACKET FLEXIBLE**

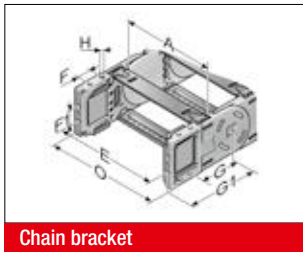

Chain bracket

This chain bracket offers universal connection options (top, bottom and front) and is attached to the ends of the chain like a side link. This allows the chain to move right up to the bracket. Each chain requires one male and one female bracket. M5 screws and insert panels are used to secure the brackets in place.

By default, the chain bracket is supplied with frame bridges.

The chain bracket can then be optionally fitted with frame bridge strain relief plates (RS-ZL) or with strain relief using C-rails and type STF bow clamps.

Type	Order No.	Material	Inside width								Outside width of KA 0 mm
			A mm	E mm	F mm	F1 mm	G mm	G1 mm	H mm	H0 mm	
KA25	KA25ML	Plastic	40.0 – 200.0	A+9.0	12.0	12.0	42.5	70.0	M5	5.5	A+18.0

**Configurator chain bracketKA25**

Configurator for chain brackets:

Type KA	Inside width mm	Radius mm	RS-ZL No. Pieces	C-profile No. Pieces	No. of EB** Pieces
KA 25*	085	250	2	0	2

**Ordering example:**

- Type = KA 25 = Chain bracket flexible for MP 25
- Internal width = 085 mm
- Radius = 250 mm
- Crossbar-strain relief (RS-ZL) = 2 pieces
- C-rail = 0 pieces
- Insert panel (EB) = 2 pieces

\* One set chain bracket is needed per chain, containing male and female end

\*\* Two insert panels (EB) are needed per connection element

**Note:**

For an exact determination of the chain bracket, the inside width and radius are absolutely essential. Optional frame bridge strain relief (RS-ZL), C-profiles and insert panels (EB) can be selected.

**MP 25 SEPARATOR / SHELVING SYSTEM**

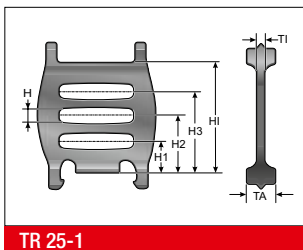

TR 25-1

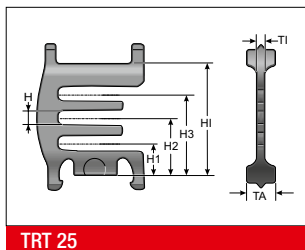

TRT 25

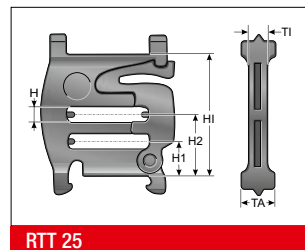

RTT 25

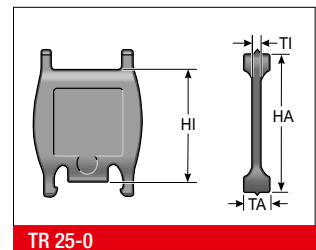

TR 25-0

We recommend that separators be used if multiple round cables

or conduits with differing diameters are to be installed.

Type	Order No.	Description	Version	T1 mm	TA mm	H mm	H1 mm	H2 mm	H3 mm	H4 mm
TR 25-0	025100009300	Separator, closed	lockable	2.2	8.0					25.0
TR 25-1	025100009400	Separator, open	lockable	2.2	8.0	3.3	7.0	12.5	18.0	25.0
TRT 25	025100009200	Separator, divisible	lockable	2.2	8.0	3.3	7.0	12.5	18.0	25.0
RTT 25	025100006500	Shelf support, divisible	lockable	4.5	8.0	3.3	7.0	12.5		25.0

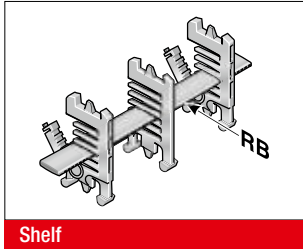
**RB-3 SHELF**

In connection with at least two separable shelf supports (RTT), the shelf becomes a shelving system. The additional levels prevent cables from criss-crossing and minimise the friction between them.

Type	Order No.	Description	Width mm	Inside width mm
RB 039-3	030100003900	Shelf	38.6	40.0
RB 041-3	1000004103	Shelf	41.1	50.0
RB 044-3	1000004403	Shelf	43.6	50.0
RB 046-3	1000004603	Shelf	46.1	50.0
RB 049-3	030100004900	Shelf	48.6	50.0
RB 051-3	1000005103	Shelf	51.1	60.0
RB 054-3	1000005403	Shelf	53.6	60.0
RB 056-3	1000005603	Shelf	56.1	60.0
RB 059-3	030100005900	Shelf	58.6	60.0
RB 061-3	1000006103	Shelf	61.1	75.0
RB 064-3	1000006403	Shelf	63.6	75.0
RB 066-3	1000006603	Shelf	66.1	75.0
RB 069-3	1000006903	Shelf	68.6	75.0
RB 071-3	1000007103	Shelf	71.1	75.0
RB 074-3	030100007400	Shelf	73.6	75.0
RB 076-3	1000007603	Shelf	76.1	85.0
RB 079-3	1000007903	Shelf	78.6	85.0
RB 081-3	1000008103	Shelf	81.1	85.0
RB 084-3	030100008400	Shelf	83.6	85.0
RB 086-3	1000008603	Shelf	86.1	100.0
RB 089-3	1000008903	Shelf	88.6	100.0
RB 091-3	1000009103	Shelf	91.1	100.0
RB 094-3	1000009403	Shelf	93.6	100.0
RB 096-3	1000009603	Shelf	96.1	100.0
RB 099-3	030100009900	Shelf	98.6	100.0
RB 101-3	1000010103	Shelf	101.1	115.0
RB 104-3	1000010403	Shelf	103.6	115.0
RB 106-3	1000010603	Shelf	106.1	115.0
RB 109-3	1000010903	Shelf	108.6	115.0
RB 111-3	1000011103	Shelf	111.1	115.0
RB 114-3	030100011400	Shelf	113.6	115.0
RB 116-3	1000011603	Shelf	116.1	125.0
RB 119-3	1000011903	Shelf	118.6	125.0
RB 121-3	1000012103	Shelf	121.1	125.0
RB 124-3	030100012400	Shelf	123.6	125.0
RB 126-3	1000012603	Shelf	126.1	150.0
RB 129-3	1000012903	Shelf	128.6	150.0
RB 131-3	1000013103	Shelf	131.1	150.0
RB 134-3	1000013403	Shelf	133.6	150.0

**RB-3 SHELF**

Type	Order No.	Description	Width mm	Inside width mm
RB 136-3	1000013603	Shelf	136.1	150.0
RB 139-3	1000013903	Shelf	138.6	150.0
RB 141-3	1000014103	Shelf	141.1	150.0
RB 144-3	1000014403	Shelf	143.6	150.0
RB 146-3	1000014603	Shelf	146.1	150.0
RB 149-3	030100014900	Shelf	148.6	150.0
RB 151-3	1000015103	Shelf	151.1	175.0
RB 154-3	1000015403	Shelf	153.6	175.0
RB 156-3	1000015603	Shelf	156.1	175.0
RB 159-3	1000015903	Shelf	158.6	175.0
RB 161-3	1000016103	Shelf	161.1	175.0
RB 164-3	1000016403	Shelf	163.6	175.0
RB 166-3	1000016603	Shelf	166.1	175.0
RB 169-3	1000016903	Shelf	168.6	175.0
RB 174-3	030100017400	Shelf	173.6	175.0
RB 176-3	1000017603	Shelf	176.1	200.0
RB 179-3	1000017903	Shelf	178.6	200.0
RB 181-3	1000018103	Shelf	181.1	200.0
RB 184-3	1000018403	Shelf	183.6	200.0
RB 186-3	1000018603	Shelf	186.1	200.0
RB 189-3	1000018903	Shelf	188.6	200.0
RB 191-3	1000019103	Shelf	191.1	200.0
RB 194-3	1000019403	Shelf	193.6	200.0
RB 196-3	1000019603	Shelf	196.1	200.0
RB 199-3	030100019900	Shelf	198.6	200.0

**RBD-3 SOLID SHELF FLOOR**

The shelf RBD creates a horizontal separation over the entire width of the chain link. When used together with the TRT 30 separator, an additional, vertical division can be realised.

Type	Order No.	Description	Width mm	Inside width mm
RBD 040-3	030100004001	Shelf, end-to-end	40.0	40.0
RBD 050-3	030100005001	Shelf, end-to-end	50.0	50.0
RBD 060-3	030100006001	Shelf, end-to-end	60.0	60.0
RBD 075-3	030100007501	Shelf, end-to-end	75.0	75.0
RBD 085-3	030100008501	Shelf, end-to-end	85.0	85.0
RBD 100-3	030100010001	Shelf, end-to-end	100.0	100.0

**MP 25 BRUSH SUPPORT**

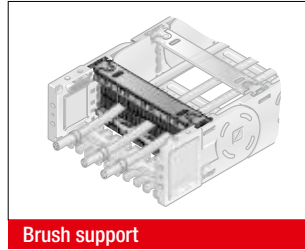
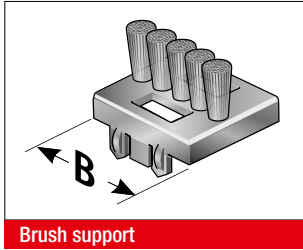

The cables in the neutral strand are routed through the brush supports. This innovative solution was developed especially for applications where cables are subjected to higher levels of wear from cyclical movement.

Type	Order No.	Description	Version	Width mm
BT 20-25, completely	025100009702	Brush support	lockable	20.0
BT 25-25, completely	025100009802	Brush support	lockable	25.0

**RS-ZL-3 CROSSBAR STRAIN RELIEF PLATE**

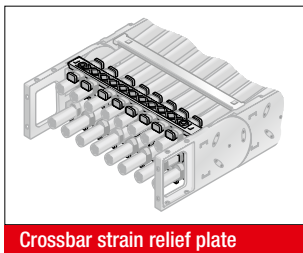

Fixed integrated frame bridge strain relief plates in the chain brackets. Tailored to all crossbar widths up to 200 mm. May be assembled on the inside and outside bends at both chain endings.

Type	Order No.	Description	Inside width mm
RS-ZL 040-3	030104000010	Crossbar strain relief plate	40.0
RS-ZL 050-3	030105000010	Crossbar strain relief plate	50.0
RS-ZL 060-3	030106000010	Crossbar strain relief plate	60.0
RS-ZL 075-3	030107500010	Crossbar strain relief plate	75.0
RS-ZL 085-3	030108500010	Crossbar strain relief plate	85.0
RS-ZL 100-3	030110000010	Crossbar strain relief plate	100.0
RS-ZL 125-3	030112500010	Crossbar strain relief plate	125.0
RS-ZL 150-3	030115000010	Crossbar strain relief plate	150.0
RS-ZL 200-3	030120000010	Crossbar strain relief plate	200.0

**STRAIN RELIEF WITH STEEL FIX**

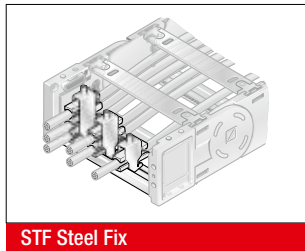
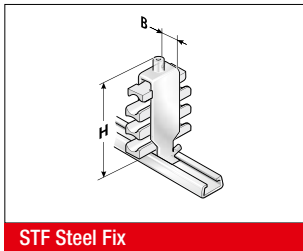

C-rails (galvanised) for permanent integration, for accommodating the Steel Fix bow clamps in the chain brackets. The bow clamps can take up to 3 cables and are suitable for C-rails with a groove width of 11 mm. Due to the design of the trough elements, a cable preserving cable guidance is ensured. May be assembled on the inside and outside bends at both chain endings. The overall height stated is a guide only. The actual height is, amongst other things, dependent on the diameter and the quality of the cable. A safety distance of 10 mm at the fixed point above the strain relief must be kept during gliding applications.

Type	Order No.	Description	Seats qty.	Cable Ø mm	Width mm	Total height (H) mm
<b>Single clamp (for one cable)</b>						
STF 12-1 Steel Fix	81661801	Hooped clamp	1	6.0 – 12.0	16.0	55.0
STF 14-1 Steel Fix	81661802	Hooped clamp	1	12.0 – 14.0	18.0	52.0
STF 16-1 Steel Fix	81661803	Hooped clamp	1	14.0 – 16.0	20.0	54.0
STF 18-1 Steel Fix	81661804	Hooped clamp	1	16.0 – 18.0	22.0	56.0
STF 20-1 Steel Fix	81661805	Hooped clamp	1	18.0 – 20.0	24.0	59.0
STF 22-1 Steel Fix	81661806	Hooped clamp	1	20.0 – 22.0	26.0	61.0
STF 26-1 Steel Fix	81661807	Hooped clamp	1	22.0 – 26.0	30.0	70.0
STF 30-1 Steel Fix	81661808	Hooped clamp	1	26.0 – 30.0	34.0	74.0
STF 34-1 Steel Fix	81661809	Hooped clamp	1	30.0 – 34.0	38.0	78.0
STF 38-1 Steel Fix	81661810	Hooped clamp	1	34.0 – 38.0	42.0	82.0
STF 42-1 Steel Fix	81661811	Hooped clamp	1	38.0 – 42.0	46.0	91.0
<b>Double clamp (for two cables)</b>						
STF 12-2 Steel Fix	81661821	Hooped clamp	2	6.0 – 12.0	16.0	73.0
STF 14-2 Steel Fix	81661822	Hooped clamp	2	12.0 – 14.0	18.0	74.0
STF 16-2 Steel Fix	81661823	Hooped clamp	2	14.0 – 16.0	20.0	82.0
STF 18-2 Steel Fix	81661824	Hooped clamp	2	16.0 – 18.0	22.0	86.0
STF 20-2 Steel Fix	81661825	Hooped clamp	2	18.0 – 20.0	24.0	91.0
STF 22-2 Steel Fix	81661826	Hooped clamp	2	20.0 – 22.0	26.0	95.0
STF 26-2 Steel Fix	81661827	Hooped clamp	2	22.0 – 26.0	30.0	108.0
STF 30-2 Steel Fix	81661828	Hooped clamp	2	26.0 – 30.0	34.0	121.0
STF 34-2 Steel Fix	81661829	Hooped clamp	2	30.0 – 34.0	38.0	129.0
<b>Triple clamp (for three cables)</b>						
STF 12-3 Steel Fix	81661841	Hooped clamp	3	6.0 – 12.0	16.0	98.0
STF 14-3 Steel Fix	81661842	Hooped clamp	3	12.0 – 14.0	18.0	98.0
STF 16-3 Steel Fix	81661843	Hooped clamp	3	14.0 – 16.0	20.0	105.0
STF 18-3 Steel Fix	81661844	Hooped clamp	3	16.0 – 18.0	22.0	111.0
STF 20-3 Steel Fix	81661845	Hooped clamp	3	18.0 – 20.0	24.0	118.0
STF 22-3 Steel Fix	81661846	Hooped clamp	3	20.0 – 22.0	26.0	130.0

**MP 25 LOWERED FIXING POINT**

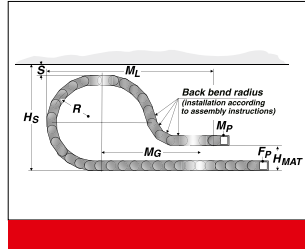
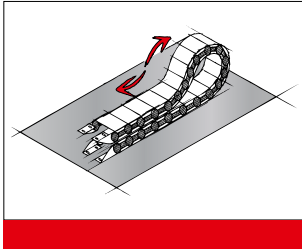

It is sometimes necessary to lower the height of the moving attachment point.

In such cases, modifications to the chain layout should be noted (e.g. extension of chain).

Please contact our application engineers.

Radius R mm	Height of moving end bracket (H <sub>MA</sub> ) mm	Safety margin (S) mm	Installation height incl. safety (H <sub>S</sub> ) mm	Projection (M <sub>L</sub> ) mm	Additional links qty.	of which additional back chain links qty.
100.0	100.0	50.0	287.0	290.0	5	3
125.0	100.0	50.0	337.0	340.0	6	3
150.0	100.0	50.0	387.0	450.0	8	5
200.0	100.0	50.0	487.0	590.0	11	6
250.0	100.0	50.0	587.0	710.0	14	7
300.0	100.0	50.0	687.0	810.0	17	8

**MP 25.1/2 REARWARD RADII**

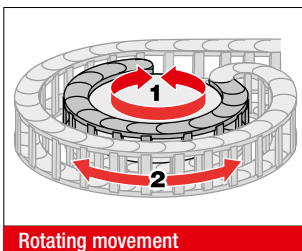

Side links with rearward radius allow movements in both directions. This is intended for rotating movements and lowered chain brackets. The appropriate number of washer discs have to be placed into the side links to achieve the rearward radius.

Type	Order No.
AS 25 (RÜ075/R075) left	025100007560
AS 25 (RÜ075/R075) right	025100007562
AS 25 (RÜ100/R100) left	025100010060
AS 25 (RÜ100/R100) right	025100010062

**GUIDE CHANNEL VAW (ALUMINIUM / STAINLESS STEEL)**



VAW steel galvanised / stainless steel



VAW aluminium

A range of variable guide channel systems, constructed from aluminium or stainless steel sections, are available for this energy chain.

The variable guide channel ensures that the energy chain is supported and guided securely.



**ASSEMBLY**

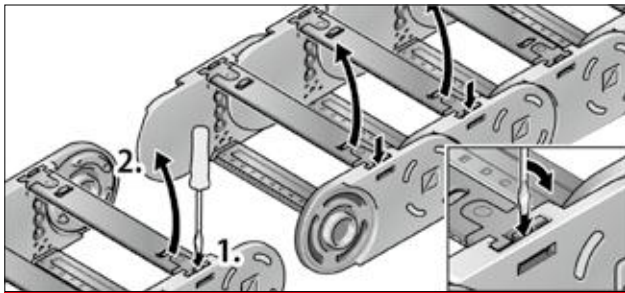

Step 1

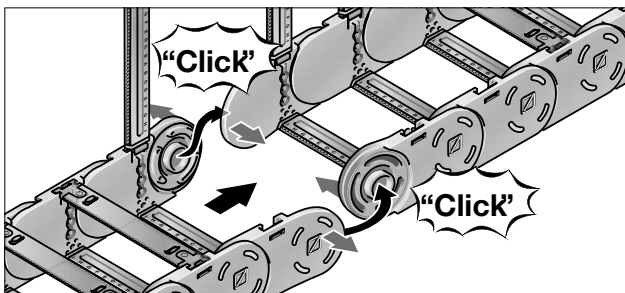

Step 2

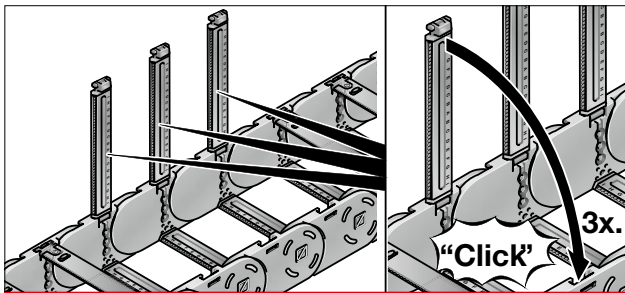

Step 3

**DISASSEMBLY**

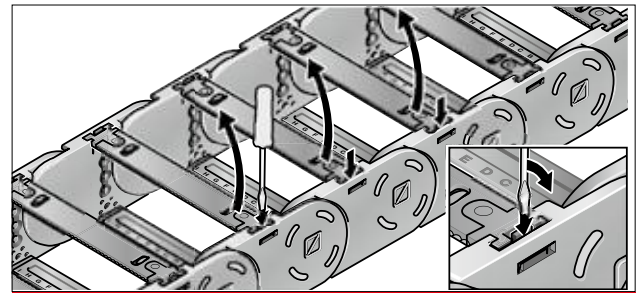

Step 1

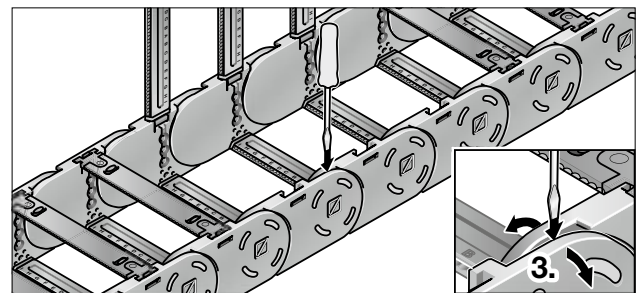

Step 2

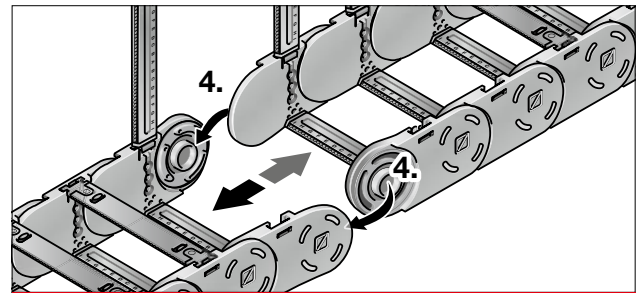

Step 3

**MP 30.1/.2**  
OPEN



**MP 30.3/.4**  
CLOSED

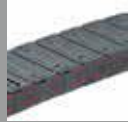

- BROAD INTERIOR LAYOUT
- BRUSH SUPPORT
- CHAIN BRACKET WITH INTEGRATED STRAIN RELIEF
- SUITABLE FOR UNIVERSAL USE

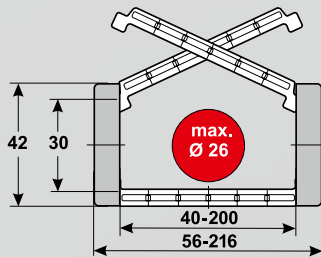

## TECHNICAL DATA

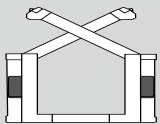

**Loading side**  
Inside or outside bend

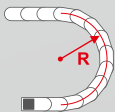

**Available radii**  
60.0 – 300.0 mm

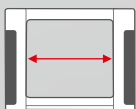

**Available interior widths**  
With plastic crossbar  
40.0 – 200.0 mm

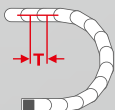

**Pitch**  
T = 50.0 mm

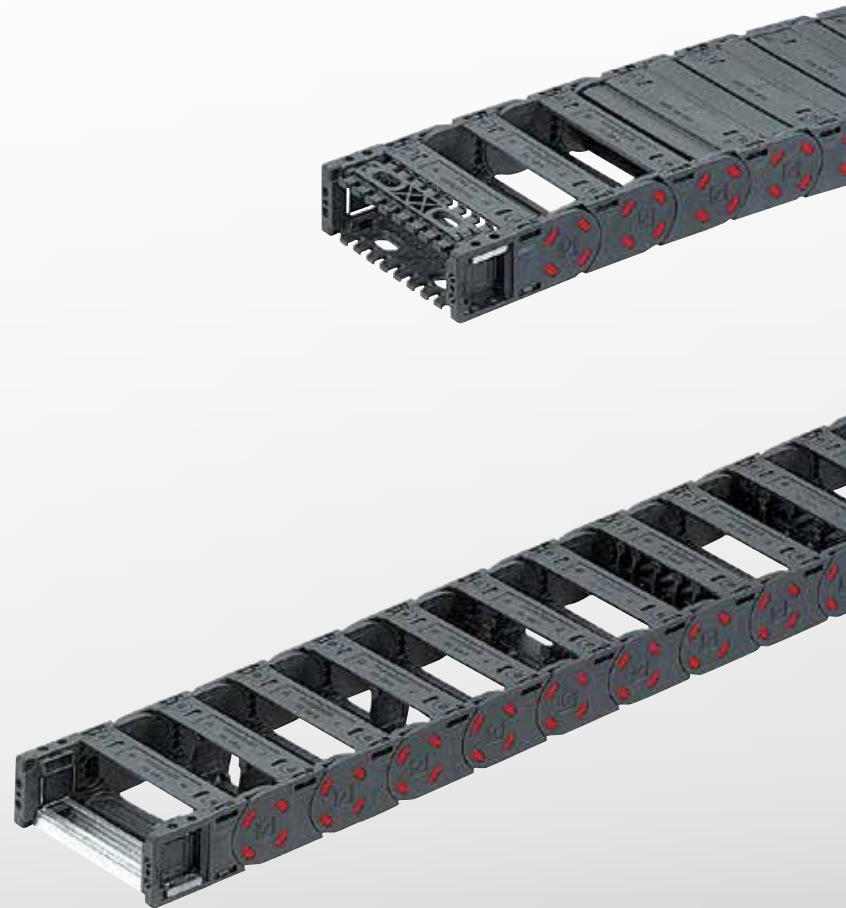

## TECHNICAL SPECIFICATIONS

Travel distance gliding $L_g$ max.	40.0 m
Travel distance self-supporting $L_s$ max.	see diagram on page 177
Travel distance vertical, hanging $L_{vh}$ max.	30.0 m
Travel distance vertical, upright $L_{vs}$ max.	3.0 m
Rotated 90°, unsupported $L_{90f}$ max.	0.7 m
Speed, gliding $V_g$ max.	3.0 m/s
Speed, self-supporting $V_f$ max.	10.0 m/s
Acceleration, gliding $a_g$ max.	10.0 m/s <sup>2</sup>
Acceleration, self-supporting $a_s$ max.	15.0 m/s <sup>2</sup>

Contact our engineering department to meet any higher requirements: [efk@murrplastik.de](mailto:efk@murrplastik.de)



## MATERIAL PROPERTIES

Standard material	Polyamide (PA) black
Service temperature	-30.0 – 120.0 °C
Gliding friction factor	0.3
Static friction factor	0.45
Fire classification	UL 94 HB

Other material properties on request.

## SHELVING SYSTEM



Separator TR

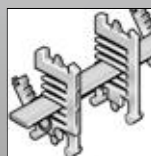

RS shelving system

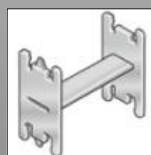

H-shaped shelf unit RE

## GUIDE CHANNELS



VAW steel galvanised / stainless steel

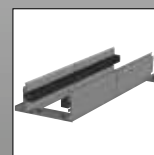

VAW aluminium

## STRAIN RELIEF



RS-ZL crossbar strain relief



STF Steel Fix

## CHAIN BRACKET

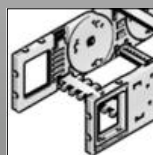

Chain bracket flexible

**ORDERING KEY**

Dimensions in mm [US inch]

Type code	Variation	Inside width	Outside width	Inside width	Outside width	Radius	Crossbar variant	Material	Chain length																																																																																												
0030 01	Crossbar on outside bend Crossbar on inside bend Opens on outside bend	040 [1.57]	056 [2.20]			060 <sup>1)</sup> [2.36]	0 Plastic, full-ridged with bias	0 Polyamide standard (PA/black)																																																																																													
		050 [1.97]	066 [2.60]							0030 02	Crossbar on outside bend Crossbar on inside bend Opens on inside bend	060 [2.36]	076 [2.99]			075 <sup>1)</sup> [2.95]	1 Plastic, full-ridged without bias	7 EMC (PA/light grey)		075 [2.95]	091 [3.58]			0030 03	Cover on outside bend Cover on inside bend Opens on outside bend	085 [3.35]	101 [3.98]			100 [3.94]		9 Special version (on request)		100 [3.94]	116 [4.57]			0030 04	Cover on outside bend Cover on inside bend Opens on inside bend	125 [4.92]	141 [5.55]			125 [4.92]				150 [5.91]	166 [6.54]			0030 05	Cover on outside bend Crossbar on inside bend Opens on outside bend	200 [7.87]	216 [8.50]			150 [5.91]								0030 06	Cover on outside bend Crossbar on inside bend Opens on inside bend					200 [7.87]								0030 07	Crossbar on outside bend Cover on inside bend Opens on outside bend					250 [9.84]								0030 08	Crossbar on outside bend Cover on inside bend Opens on inside bend					300 [11.81]	
0030 02	Crossbar on outside bend Crossbar on inside bend Opens on inside bend	060 [2.36]	076 [2.99]			075 <sup>1)</sup> [2.95]	1 Plastic, full-ridged without bias	7 EMC (PA/light grey)																																																																																													
		075 [2.95]	091 [3.58]							0030 03	Cover on outside bend Cover on inside bend Opens on outside bend	085 [3.35]	101 [3.98]			100 [3.94]		9 Special version (on request)		100 [3.94]	116 [4.57]			0030 04	Cover on outside bend Cover on inside bend Opens on inside bend	125 [4.92]	141 [5.55]			125 [4.92]				150 [5.91]	166 [6.54]			0030 05	Cover on outside bend Crossbar on inside bend Opens on outside bend	200 [7.87]	216 [8.50]			150 [5.91]								0030 06	Cover on outside bend Crossbar on inside bend Opens on inside bend					200 [7.87]								0030 07	Crossbar on outside bend Cover on inside bend Opens on outside bend					250 [9.84]								0030 08	Crossbar on outside bend Cover on inside bend Opens on inside bend					300 [11.81]															
0030 03	Cover on outside bend Cover on inside bend Opens on outside bend	085 [3.35]	101 [3.98]			100 [3.94]		9 Special version (on request)																																																																																													
		100 [3.94]	116 [4.57]							0030 04	Cover on outside bend Cover on inside bend Opens on inside bend	125 [4.92]	141 [5.55]			125 [4.92]				150 [5.91]	166 [6.54]			0030 05	Cover on outside bend Crossbar on inside bend Opens on outside bend	200 [7.87]	216 [8.50]			150 [5.91]								0030 06	Cover on outside bend Crossbar on inside bend Opens on inside bend					200 [7.87]								0030 07	Crossbar on outside bend Cover on inside bend Opens on outside bend					250 [9.84]								0030 08	Crossbar on outside bend Cover on inside bend Opens on inside bend					300 [11.81]																													
0030 04	Cover on outside bend Cover on inside bend Opens on inside bend	125 [4.92]	141 [5.55]			125 [4.92]																																																																																															
		150 [5.91]	166 [6.54]							0030 05	Cover on outside bend Crossbar on inside bend Opens on outside bend	200 [7.87]	216 [8.50]			150 [5.91]								0030 06	Cover on outside bend Crossbar on inside bend Opens on inside bend					200 [7.87]								0030 07	Crossbar on outside bend Cover on inside bend Opens on outside bend					250 [9.84]								0030 08	Crossbar on outside bend Cover on inside bend Opens on inside bend					300 [11.81]																																											
0030 05	Cover on outside bend Crossbar on inside bend Opens on outside bend	200 [7.87]	216 [8.50]			150 [5.91]																																																																																															
										0030 06	Cover on outside bend Crossbar on inside bend Opens on inside bend					200 [7.87]								0030 07	Crossbar on outside bend Cover on inside bend Opens on outside bend					250 [9.84]								0030 08	Crossbar on outside bend Cover on inside bend Opens on inside bend					300 [11.81]																																																									
0030 06	Cover on outside bend Crossbar on inside bend Opens on inside bend					200 [7.87]																																																																																															
										0030 07	Crossbar on outside bend Cover on inside bend Opens on outside bend					250 [9.84]								0030 08	Crossbar on outside bend Cover on inside bend Opens on inside bend					300 [11.81]																																																																							
0030 07	Crossbar on outside bend Cover on inside bend Opens on outside bend					250 [9.84]																																																																																															
										0030 08	Crossbar on outside bend Cover on inside bend Opens on inside bend					300 [11.81]																																																																																					
0030 08	Crossbar on outside bend Cover on inside bend Opens on inside bend					300 [11.81]																																																																																															

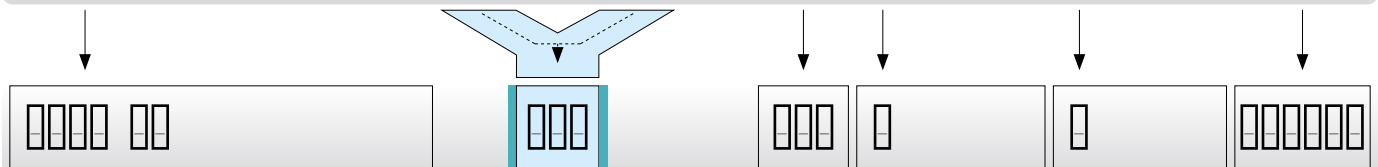

**ORDERING EXAMPLE: 0030 01 040 060 0 0 1250**

Crossbar on outside bend, crossbar on inside bend, can be opened from outside bend  
 Inside width 40 mm; radius 60 mm  
 Plastic crossbar, full-ridged with bias, material black-coloured polyamide  
 Chain length 1250 mm (25 links)

<sup>1)</sup> only for Version 01 and 02

**SELF-SUPPORTING LENGTH**

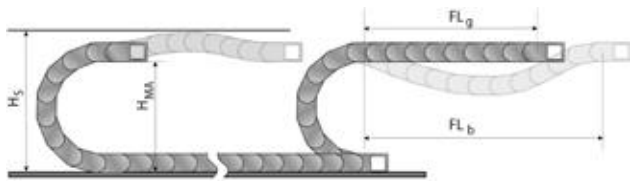

The self-supporting length is the distance between the chain bracket on the moving end and the start of the chain arch.  
 The installation variant  $FL_g$  offers the lowest load and wear for the energy chain.  
 The maximum travel parameters (speed and acceleration) can be applied for this variant.

- $H_s$  = Installation height plus safety
- $H_{MA}$  = Height of moving end connection
- $FL_g$  = Self-supporting length, upper run straight
- $FL_b$  = Self-supporting length, upper run bent

**LOAD DIAGRAM FOR SELF-SUPPORTING APPLICATIONS**

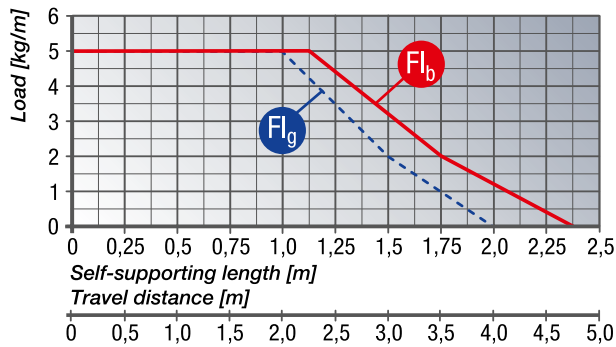

**$FL_g$  Self-supporting length, upper run straight**  
 In the  $FL_g$  range, the chain upper run still has a bias, is straight or has a maximum sag of 60.0 mm.

**$FL_b$  Self-supporting length, upper run bent**  
 In the  $FL_b$  range, the chain upper run has a sag of more than 60.0 mm, but this is still less than the maximum sag. Where the sag is greater than that permitted in the  $FL_b$  range, the application is critical and should be avoided. The self-supporting length can be optimised by using a support for the upper run or a more stable energy chain.  
 Closed energy chains (with covers) have a higher unit weight than open chains (with crossbars). This higher weight must be taken into account when calculating the self-supporting length. To the weight of the cabling (cable load, in kg/m), you must add 0.3 kg/m, to account for the higher weight of closed-cover chains.

**DETERMINING THE CHAIN LENGTH**

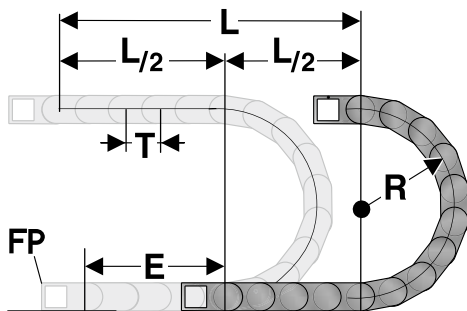

The fixed point of the energy chain should be connected in the middle of the travel distance.  
 This arrangement gives the shortest connection between the fixed point (FP) and the moving consumer and thus the most efficient chain length.

Chain length calculation =  $L/2 + \pi * R + E$   
 $\approx 1 \text{ m chain} = 20 \text{ qty. } \times 50.0 \text{ mm.}$

- E = Distance between entry point and middle of travel distance
- L = Travel distance
- R = Radius
- P = Pitch 50.0 mm

**INSTALLATION DIMENSIONS**

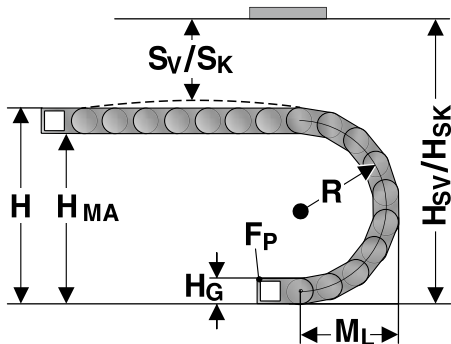

The moving end chain connection is to be screw fixed at height  $H_{MA}$  for the respective radius.

Concerning the installed dimensions, you must take into account whether the chain links are equipped with or without bias.

For chain links without bias, the “Installed height without bias  $H_{SK}$ ” value has to be taken into account.

If the chain links are equipped with a bias, the value “Installed height with bias  $H_{SV}$ ” has to be taken into account.

Radius R	60	75	100	125	150	200	250	300
Outside height of chain link ( $H_G$ )	42	42	42	42	42	42	42	42
Height of bend (H)	182	212	262	312	362	462	562	662
Height of moving end bracket ( $H_{MA}$ )	140	170	220	270	320	420	520	620
Safety margin with bias ( $S_V$ )	38	38	38	38	38	38	38	38
Installation height with bias ( $H_{SV}$ )	220	250	300	350	400	500	600	700
Safety margin without bias ( $S_K$ )	18	18	18	18	18	18	18	18
Installation height without bias ( $H_{SK}$ )	200	230	280	330	380	480	580	680
Arc projection ( $M_L$ )	141	156	181	206	231	281	331	381

**EB 25/30 INSERT PANEL**

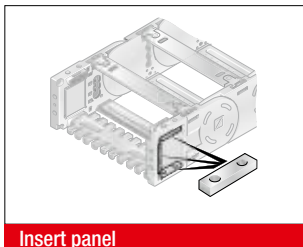

To fix the chain connection, the insert panels can be inserted above, below or on the side and are available with threads or through-holes.

Type	Order No.	Description	Holes mm	Thread
EB 25/30-FG V2A	030100005502	Insert panel with thread		M5x0,8
EB 25/30-FB V2A	030100005500	Insert panel with through-hole	5.5	

**KA 30 CHAIN BRACKET FLEXIBLE**

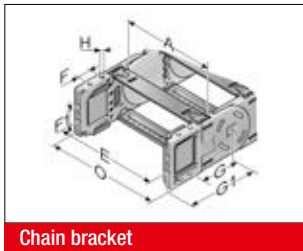

Chain bracket

This chain bracket offers universal connection options (top, bottom and front) and is attached to the ends of the chain like a side link. This allows the chain to move right up to the bracket. Each chain requires one male and one female bracket. M5 screws and insert panels are used to secure the brackets in place.

By default, the chain bracket is supplied with frame bridges.

The chain bracket can then be optionally fitted with frame bridge strain relief plates (RS-ZL) or with strain relief using C-rails and type STF bow clamps.

Type	Order No.	Material	Inside width								Outside width of KA 0 mm
			A mm	E mm	F mm	F1 mm	G mm	G1 mm	H mm	H0 mm	
KA30	KA30ML	Plastic	40.0 – 200.0	A+9.0	12.0	12.0	45.0	72.0	M5	5.5	A+18.0

**Configurator chain bracket KA 30**

Configurator for chain brackets:

Type KA	Inside width mm	Radius mm	RS-ZL number of Pieces	C-profile number of Pieces	No. of EB**
KA 30*	085	250	2	0	2

**Ordering example:**

- Type = KA 30 = Chain bracket flexible for MP 30
- Internal width = 085 mm
- Radius = 250 mm
- Crossbar-strain relief (RS-ZL) = 2 pieces
- C-rail = 0 pieces
- Insert panel (EB) = 2 pieces

\* One set chain bracket is needed per chain, containing male and female end

\*\* Two insert panels (EB) are needed per connection element

**Note:**

For an exact determination of the chain bracket, the inside width and radius are absolutely essential. Optional frame bridge strain relief (RS-ZL), C-profiles and insert panels (EB) can be selected.

**MP 30 SEPARATOR / SHELVING SYSTEM**

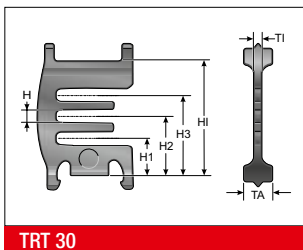

TRT 30

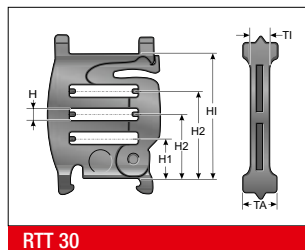

RTT 30

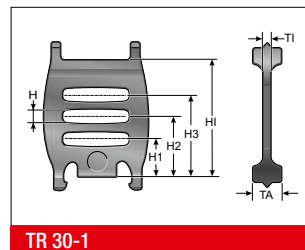

TR 30-1

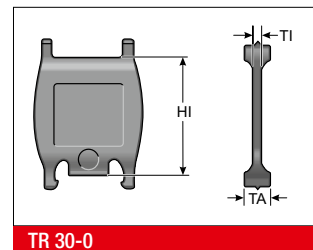

TR 30-0

We recommend that separators be used if multiple round cables

or conduits with differing diameters are to be installed.

Type	Order No.	Description	Version	T1 mm	TA mm	H mm	H1 mm	H2 mm	H3 mm	HI mm
TR 30-0	030100009300	Separator, closed	lockable	2.2	8.0					30.0
TR 30-1	030100009400	Separator, open	lockable	2.2	8.0	3.3	9.5	15.0	20.5	30.0
TRT 30	030100009200	Separator, divisible	lockable	2.2	8.0	3.3	9.5	15.0	20.5	30.0
RTT 30	030100006500	Shelf support, divisible	lockable	4.5	8.0	3.3	9.5	15.0	20.5	30.0

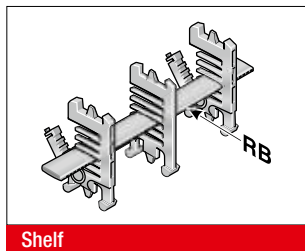
**RB-3 SHELF**

In connection with at least two separable shelf supports (RTT), the shelf becomes a shelving system. The additional levels prevent cables from criss-crossing and minimise the friction between them.

Type	Order No.	Description	Width mm	Inside width mm
RB 039-3	030100003900	Shelf	38.6	40.0
RB 041-3	1000004103	Shelf	41.1	50.0
RB 044-3	1000004403	Shelf	43.6	50.0
RB 046-3	1000004603	Shelf	46.1	50.0
RB 049-3	030100004900	Shelf	48.6	50.0
RB 051-3	1000005103	Shelf	51.1	60.0
RB 054-3	1000005403	Shelf	53.6	60.0
RB 056-3	1000005603	Shelf	56.1	60.0
RB 059-3	030100005900	Shelf	58.6	60.0
RB 061-3	1000006103	Shelf	61.1	75.0
RB 064-3	1000006403	Shelf	63.6	75.0
RB 066-3	1000006603	Shelf	66.1	75.0
RB 069-3	1000006903	Shelf	68.6	75.0
RB 071-3	1000007103	Shelf	71.1	75.0
RB 074-3	030100007400	Shelf	73.6	75.0
RB 076-3	1000007603	Shelf	76.1	85.0
RB 079-3	1000007903	Shelf	78.6	85.0
RB 081-3	1000008103	Shelf	81.1	85.0
RB 084-3	030100008400	Shelf	83.6	85.0
RB 086-3	1000008603	Shelf	86.1	100.0
RB 089-3	1000008903	Shelf	88.6	100.0
RB 091-3	1000009103	Shelf	91.1	100.0
RB 094-3	1000009403	Shelf	93.6	100.0
RB 096-3	1000009603	Shelf	96.1	100.0
RB 099-3	030100009900	Shelf	98.6	100.0
RB 101-3	1000010103	Shelf	101.1	115.0
RB 104-3	1000010403	Shelf	103.6	115.0
RB 106-3	1000010603	Shelf	106.1	115.0
RB 109-3	1000010903	Shelf	108.6	115.0
RB 111-3	1000011103	Shelf	111.1	115.0
RB 114-3	030100011400	Shelf	113.6	115.0
RB 116-3	1000011603	Shelf	116.1	125.0
RB 119-3	1000011903	Shelf	118.6	125.0
RB 121-3	1000012103	Shelf	121.1	125.0
RB 124-3	030100012400	Shelf	123.6	125.0
RB 126-3	1000012603	Shelf	126.1	150.0
RB 129-3	1000012903	Shelf	128.6	150.0



**RB-3 SHELF**

Type	Order No.	Description	Width mm	Inside width mm
RB 131-3	1000013103	Shelf	131.1	150.0
RB 134-3	1000013403	Shelf	133.6	150.0
RB 136-3	1000013603	Shelf	136.1	150.0
RB 139-3	1000013903	Shelf	138.6	150.0
RB 141-3	1000014103	Shelf	141.1	150.0
RB 144-3	1000014403	Shelf	143.6	150.0
RB 146-3	1000014603	Shelf	146.1	150.0
RB 149-3	030100014900	Shelf	148.6	150.0
RB 151-3	1000015103	Shelf	151.1	175.0
RB 154-3	1000015403	Shelf	153.6	175.0
RB 156-3	1000015603	Shelf	156.1	175.0
RB 159-3	1000015903	Shelf	158.6	175.0
RB 161-3	1000016103	Shelf	161.1	175.0
RB 164-3	1000016403	Shelf	163.6	175.0
RB 166-3	1000016603	Shelf	166.1	175.0
RB 169-3	1000016903	Shelf	168.6	175.0
RB 174-3	030100017400	Shelf	173.6	175.0
RB 176-3	1000017603	Shelf	176.1	200.0
RB 179-3	1000017903	Shelf	178.6	200.0
RB 181-3	1000018103	Shelf	181.1	200.0
RB 184-3	1000018403	Shelf	183.6	200.0
RB 186-3	1000018603	Shelf	186.1	200.0
RB 189-3	1000018903	Shelf	188.6	200.0
RB 191-3	1000019103	Shelf	191.1	200.0
RB 194-3	1000019403	Shelf	193.6	200.0
RB 196-3	1000019603	Shelf	196.1	200.0
RB 199-3	030100019900	Shelf	198.6	200.0

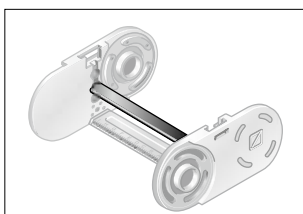
**RBD-3 SOLID SHELF FLOOR**

Shelf, end-to-end RBD

The shelf RBD creates a horizontal separation over the entire width of the chain link. When used together with the TRT 30 separator, an additional, vertical division can be realised.

Type	Order No.	Description	Width mm	Inside width mm
RBD 040-3	030100004001	Shelf, end-to-end	40.0	40.0
RBD 050-3	030100005001	Shelf, end-to-end	50.0	50.0
RBD 060-3	030100006001	Shelf, end-to-end	60.0	60.0
RBD 075-3	030100007501	Shelf, end-to-end	75.0	75.0
RBD 085-3	030100008501	Shelf, end-to-end	85.0	85.0
RBD 100-3	030100010001	Shelf, end-to-end	100.0	100.0

### RE 30 H-SHAPED SHELF UNIT

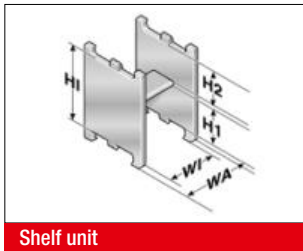

One-piece shelving system, the shelf cannot be varied in height.

Type	Order No.	Description	WA mm	WI mm	H1 mm	H2 mm	HI mm
RE 30/15	100000301510	H-shaped shelf unit	20.0	15.0	15.8	11.8	29.7
RE 30/32 K5	100000303210	H-shaped shelf unit	37.4	32.6	15.8	11.8	29.7

### MP 30 BRUSH SUPPORT

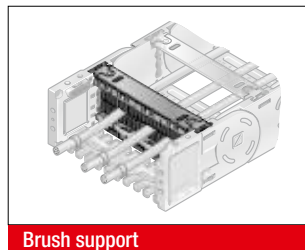
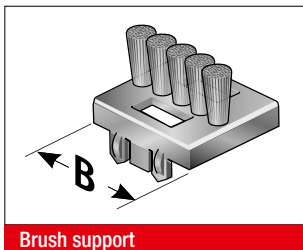

The cables in the neutral strand are routed through the brush supports. This innovative solution was developed especially for applications where cables are subjected to higher levels of wear from cyclical movement.

Type	Order No.	Description	Width mm
BT 20-30, completely	030100009702	Brush support	20.0
BT 25-30, completely	030100009802	Brush support	25.0

### RS-ZL-3 CROSSBAR STRAIN RELIEF PLATE

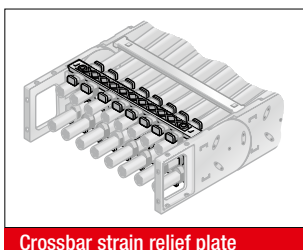

Fixed integrated frame bridge strain relief plates in the chain brackets. Tailored to all crossbar widths up to 200 mm. May be assembled on the inside and outside bends at both chain endings.

Type	Order No.	Description	Inside width mm
RS-ZL 040-3	030104000010	Crossbar strain relief plate	40.0
RS-ZL 050-3	030105000010	Crossbar strain relief plate	50.0
RS-ZL 060-3	030106000010	Crossbar strain relief plate	60.0
RS-ZL 075-3	030107500010	Crossbar strain relief plate	75.0
RS-ZL 085-3	030108500010	Crossbar strain relief plate	85.0
RS-ZL 100-3	030110000010	Crossbar strain relief plate	100.0
RS-ZL 125-3	030112500010	Crossbar strain relief plate	125.0
RS-ZL 150-3	030115000010	Crossbar strain relief plate	150.0
RS-ZL 200-3	030120000010	Crossbar strain relief plate	200.0

**STRAIN RELIEF WITH STEEL FIX**

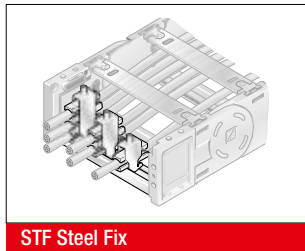
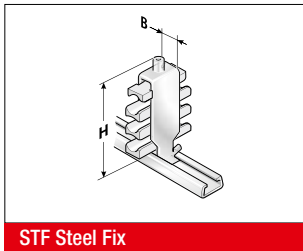

C-rails (galvanised) for permanent integration, for accommodating the Steel Fix bow clamps in the chain brackets. The bow clamps can take up to 3 cables and are suitable for C-rails with a groove width of 11 mm. Due to the design of the trough elements, a cable preserving cable guidance is ensured. May be assembled on the inside and outside bends at both chain endings. The overall height stated is a guide only. The actual height is, amongst other things, dependent on the diameter and the quality of the cable. A safety distance of 10 mm at the fixed point above the strain relief must be kept during gliding applications.

Type	Order No.	Description	Seats qty.	Cable Ø mm	Width mm	Total height (H) mm
<b>Single clamp (for one cable)</b>						
STF 12-1 Steel Fix	81661801	Hooped clamp	1	6.0 – 12.0	16.0	55.0
STF 14-1 Steel Fix	81661802	Hooped clamp	1	12.0 – 14.0	18.0	52.0
STF 16-1 Steel Fix	81661803	Hooped clamp	1	14.0 – 16.0	20.0	54.0
STF 18-1 Steel Fix	81661804	Hooped clamp	1	16.0 – 18.0	22.0	56.0
STF 20-1 Steel Fix	81661805	Hooped clamp	1	18.0 – 20.0	24.0	59.0
STF 22-1 Steel Fix	81661806	Hooped clamp	1	20.0 – 22.0	26.0	61.0
STF 26-1 Steel Fix	81661807	Hooped clamp	1	22.0 – 26.0	30.0	70.0
STF 30-1 Steel Fix	81661808	Hooped clamp	1	26.0 – 30.0	34.0	74.0
STF 34-1 Steel Fix	81661809	Hooped clamp	1	30.0 – 34.0	38.0	78.0
STF 38-1 Steel Fix	81661810	Hooped clamp	1	34.0 – 38.0	42.0	82.0
STF 42-1 Steel Fix	81661811	Hooped clamp	1	38.0 – 42.0	46.0	91.0
<b>Double clamp (for two cables)</b>						
STF 12-2 Steel Fix	81661821	Hooped clamp	2	6.0 – 12.0	16.0	73.0
STF 14-2 Steel Fix	81661822	Hooped clamp	2	12.0 – 14.0	18.0	74.0
STF 16-2 Steel Fix	81661823	Hooped clamp	2	14.0 – 16.0	20.0	82.0
STF 18-2 Steel Fix	81661824	Hooped clamp	2	16.0 – 18.0	22.0	86.0
STF 20-2 Steel Fix	81661825	Hooped clamp	2	18.0 – 20.0	24.0	91.0
STF 22-2 Steel Fix	81661826	Hooped clamp	2	20.0 – 22.0	26.0	95.0
STF 26-2 Steel Fix	81661827	Hooped clamp	2	22.0 – 26.0	30.0	108.0
STF 30-2 Steel Fix	81661828	Hooped clamp	2	26.0 – 30.0	34.0	121.0
STF 34-2 Steel Fix	81661829	Hooped clamp	2	30.0 – 34.0	38.0	129.0
<b>Triple clamp (for three cables)</b>						
STF 12-3 Steel Fix	81661841	Hooped clamp	3	6.0 – 12.0	16.0	98.0
STF 14-3 Steel Fix	81661842	Hooped clamp	3	12.0 – 14.0	18.0	98.0
STF 16-3 Steel Fix	81661843	Hooped clamp	3	14.0 – 16.0	20.0	105.0
STF 18-3 Steel Fix	81661844	Hooped clamp	3	16.0 – 18.0	22.0	111.0
STF 20-3 Steel Fix	81661845	Hooped clamp	3	18.0 – 20.0	24.0	118.0
STF 22-3 Steel Fix	81661846	Hooped clamp	3	20.0 – 22.0	26.0	130.0

**LOWERED FIXING POINT MP 30**

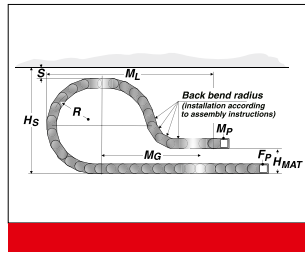
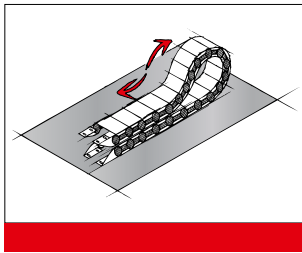

It is sometimes necessary to lower the height of the moving attachment point.

In such cases, modifications to the chain layout should be noted (e.g. extension of chain).

Please contact our application engineers.

Radius R mm	Height of moving end bracket (H <sub>MA</sub> ) mm	Safety margin (S) mm	Installation height incl. safety (H <sub>s</sub> ) mm	Projection (M <sub>1</sub> ) mm	Additional links qty.	of which additional back chain links qty.
100.0	100.0	50.0	292.0	300.0	4	3
125.0	100.0	50.0	342.0	345.0	5	3
150.0	100.0	50.0	392.0	470.0	8	5
200.0	100.0	50.0	492.0	605.0	10	6
250.0	100.0	50.0	592.0	680.0	12	7
300.0	100.0	50.0	692.0	805.0	15	7

**MP 30.1/2 REARWARD RADII**

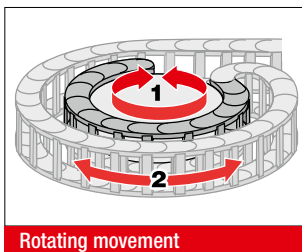

Side links with rearward radius allow movements in both directions. This is intended for rotating movements and lowered chain brackets. The appropriate number of washer discs have to be placed into the side links to achieve the rearward radius.

Type	Order No.
AS 30 (RÜ100/R100) left	030100010060
AS 30 (RÜ100/R100) right	030100010062
AS 30 (RÜ150/R150) left	030100015060
AS 30 (RÜ150/R150) right	030100015062

**GUIDE CHANNEL VAW (ALUMINIUM / STAINLESS STEEL)**



VAW steel galvanised / stainless steel



VAW aluminium

A range of variable guide channel systems, constructed from aluminium or stainless steel sections, are available for this energy chain.

The variable guide channel ensures that the energy chain is supported and guided securely.

**ASSEMBLY**

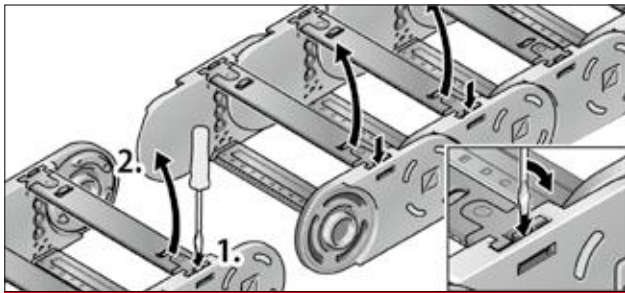

Step 1

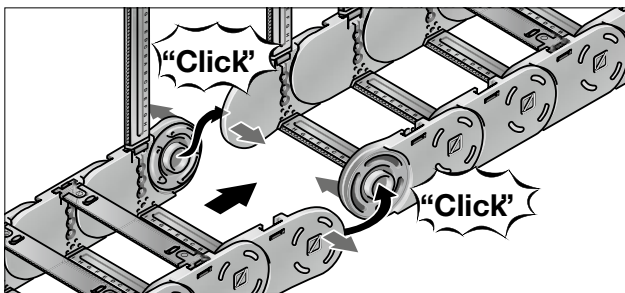

Step 2

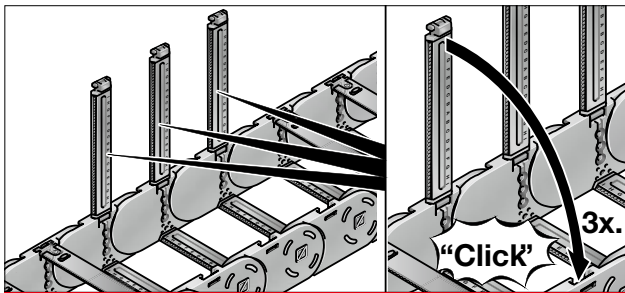

Step 3

**DISASSEMBLY**

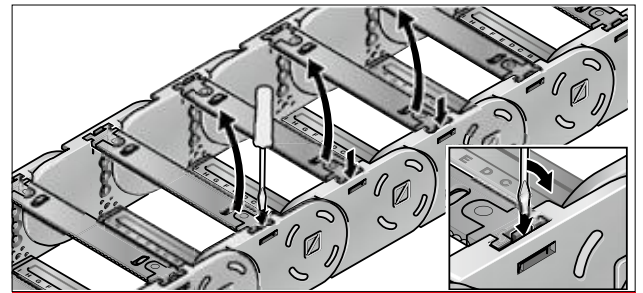

Step 1

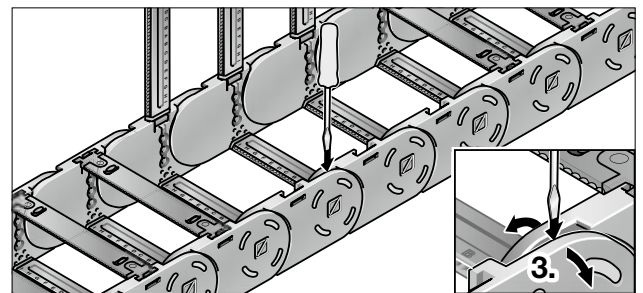

Step 2

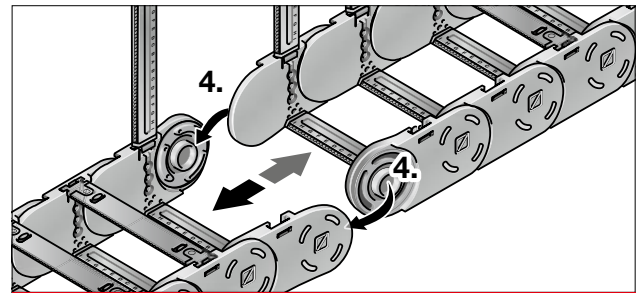

Step 3

**MP 32.2**  
OPEN



**MP 32.3**  
CLOSED



- SLIDING BLOCKS FOR LONGER SERVICE LIFE
- BROAD INTERIOR LAYOUT
- CHAIN BRACKET FLEXIBLE
- PLASTIC OR ALUMINIUM VERSION

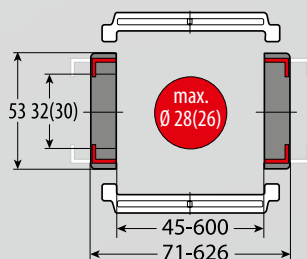

## TECHNICAL DATA

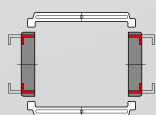

**Loading side**  
Inside and outside bend

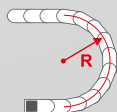

**Available radii**  
80.0 – 250.0 mm

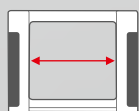

**Available interior widths**  
With plastic crossbar  
45.0 – 546.0 mm  
With alu crossbar / with alu cover  
67.0 – 600.0 mm / 43.0 – 600.0 mm

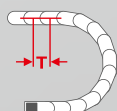

**Pitch**  
T = 64.5 mm



## TECHNICAL SPECIFICATIONS

Travel distance gliding $L_g$ max.	100.0 m
Travel distance self-supporting $L_s$ max.	see diagram on page 189
Travel distance vertical, hanging $L_{vh}$ max.	40.0 m
Travel distance vertical, upright $L_{vs}$ max.	5.0 m
Rotated 90°, unsupported $L_{90f}$ max.	1.0 m
Speed, gliding $V_g$ max.	5.0 m/s
Speed, self-supporting $V_s$ max.	20.0 m/s
Acceleration, gliding $a_g$ max.	25.0 m/s <sup>2</sup>
Acceleration, self-supporting $a_s$ max.	30.0 m/s <sup>2</sup>

Contact our engineering department to meet any higher requirements: [efk@murrplastik.de](mailto:efk@murrplastik.de)



## MATERIAL PROPERTIES

Standard material	Polyamide (PA) black
Service temperature	-30.0 – 120.0 °C
Gliding friction factor	0.3
Static friction factor	0.45
Fire classification	UL 94 HB

Other material properties on request.

### SHELVING SYSTEM



Separator TR



RS shelving system



Crossbar connector RSV

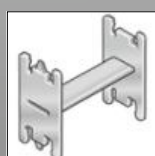

H-shaped shelf unit RE

### ACCESSORIES



Sliding block



Bracket bar



Cover

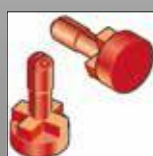

Lock button

### GUIDE CHANNELS



VAW steel galvanised / stainless steel

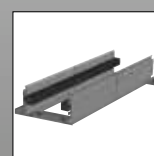

VAW aluminium

### STRAIN RELIEF



RS-ZL crossbar strain relief



STF Steel Fix

### CHAIN BRACKET

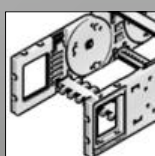

Chain bracket flexible

ORDERING KEY

Dimensions in mm [US inch]

Type code	Variation	Inside width	Outside width	Inside width	Outside width	Radius	Crossbar variant	Material	Chain length
0322 30	MP 32.2 open Crossbar on outside bend Crossbar on inside bend Opens on inside and outside bend	045 <sup>1)</sup> [1.77]	071 [2.80]	233 [9.17]	259 [10.20]	080 <sup>1)</sup> [3.15]	0 Plastic, full-ridged with bias	0 Polyamide standard (PA/black)	
		057 <sup>1)</sup> [2.24]	083 [3.27]	246 [9.69]	272 [10.71]				
0323 44 <sup>2)</sup>	MP 32.3 Closed Cover on outside bend Cover on inside bend Opens on inside and outside bend	062 [2.44]	088 [3.46]	252 [9.92]	278 [10.94]	100 <sup>1)</sup> [3.94]	2 Plastic, half-ridged with bias	5 Polypropylene (PP/blue)	
		071 [2.80]	097 [3.82]	258 [10.16]	284 [11.18]				
		084 [3.31]	110 [4.33]	296 [11.65]	322 [12.68]	120 [4.72]	4 Aluminium full-ridged with bias	7 EMC (PA/light grey)	
		093 [3.66]	119 [4.69]	346 [13.62]	372 [14.65]				
		096 [3.78]	122 [4.80]	350 [13.78]	376 [14.80]	150 [5.91]	6 Aluminium half-ridged with bias	9 Special version (on request)	
		104 [4.09]	130 [5.12]	358 [14.09]	384 [15.12]				
		107 [4.21]	133 [5.24]	371 [14.61]	397 [15.63]	200 [7.87]	9 Special version (on request)		
		121 [4.76]	147 [5.79]	396 [15.59]	422 [16.61]				
		133 [5.24]	159 [6.26]	421 [16.57]	447 [17.60]	250 [9.84]			
		144 [5.67]	170 [6.69]	446 [17.56]	472 [18.58]				
		146 [5.75]	172 [6.77]	496 [19.53]	522 [20.55]				
		158 [6.22]	184 [7.24]	546 [21.50]	572 [22.52]				
		164 [6.46]	190 [7.48]						
		171 [6.73]	197 [7.76]						
		182 [7.17]	208 [8.19]						
		196 [7.72]	222 [8.74]						
		208 [8.19]	234 [9.21]						
		220 [8.66]	246 [9.69]						



ORDERING EXAMPLE: 0322 30 045 080 0 0 1290

Crossbar on outside bend, crossbar on inside bend, can be opened from inside and outside bend  
 Inside width 045 mm; radius 80 mm  
 Plastic crossbar, full-ridged with bias, material black-coloured polyamide  
 Chain length 1290 mm (20 links)

<sup>1)</sup> for Variant 30 only  
<sup>2)</sup> reduced inner height, reduced max. cable diameter, see chain window drawing on previous page



**NOTE ON CONFIGURATION**

**Aluminium crossbars:**

Aluminium crossbars can be supplied in 1 mm width sizes for inner widths from 67.0 mm – 600.0 mm .

**Aluminium covers:**

Aluminium covers can be supplied in 1 mm width sizes for inner widths from 43.0 mm – 600.0 mm .

**Crossbar connector and crossbar strain relief plate:**

Once inside widths exceed 246 mm, we recommend the deployment of crossbar connectors (RSV).  
Crossbar connectors cannot be used in conjunction with covers made from plastic or aluminium.

If crossbar strain relief plates (RS-ZL) are to be deployed in the chain brackets, take standard inside widths into account.

For detailed information, please consult the corresponding product documentation.

**SELF-SUPPORTING LENGTH**

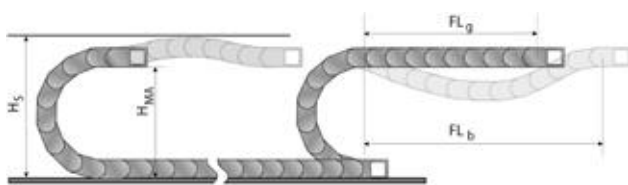

The self-supporting length is the distance between the chain bracket on the moving end and the start of the chain arch. The installation variant  $FL_g$  offers the lowest load and wear for the energy chain.  
The maximum travel parameters (speed and acceleration) can be applied for this variant.

- $H_s$  = Installation height plus safety
- $H_{MA}$  = Height of moving end connection
- $FL_g$  = Self-supporting length, upper run straight
- $FL_b$  = Self-supporting length, upper run bent

**LOAD DIAGRAM FOR SELF-SUPPORTING APPLICATIONS**

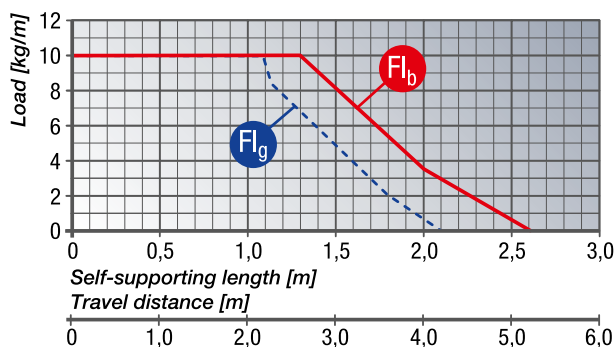

**$FL_g$  Self-supporting length, upper run straight**

In the  $FL_g$  range, the chain upper run still has a bias, is straight or has a maximum sag of 70.0 mm.

**$FL_b$  Self-supporting length, upper run bent**

In the  $FL_b$  range, the chain upper run has a sag of more than 70.0 mm, but this is still less than the maximum sag. Where the sag is greater than that permitted in the  $FL_b$  range, the application is critical and should be avoided. The self-supporting length can be optimised by using a support for the upper run or a more stable energy chain.  
Closed energy chains (with covers) have a higher unit weight than open chains (with crossbars). This higher weight must be taken into account when calculating the self-supporting length. To the weight of the cabling (cable load, in kg/m), you must add 1.5 kg/m, to account for the higher weight of closed-cover chains.

### DETERMINING THE CHAIN LENGTH

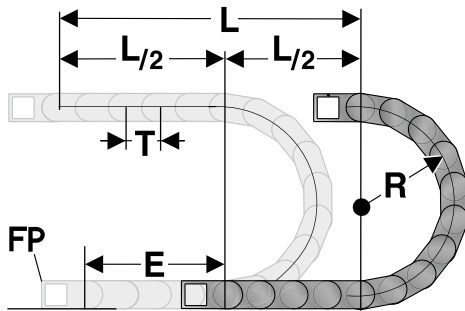

The fixed point of the energy chain should be connected in the middle of the travel distance.

This arrangement gives the shortest connection between the fixed point (FP) and the moving consumer and thus the most efficient chain length.

$$\text{Chain length calculation} = L/2 + \pi * R + E$$

$$\approx 1 \text{ m chain} = 16 \text{ qty. x64.5 mm.}$$

E = Distance between entry point and middle of travel distance

L = Travel distance

R = Radius

P = Pitch 64.5 mm

### INSTALLATION DIMENSIONS

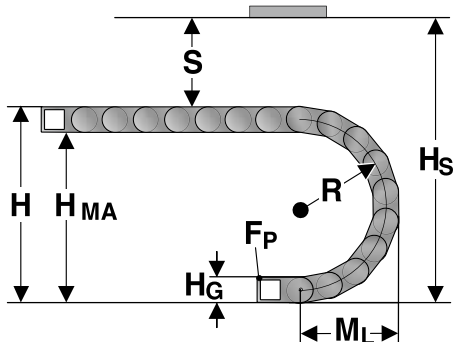

The moving end chain connection is to be screw fixed at height  $H_{MA}$  for the respective radius.

For the installed dimension the "Installed height  $H_s$ " value has to be taken into account.

Radius R	80	100	120	150	200	250
Outside height of chain link ( $H_o$ )	53	53	53	53	53	53
Height of bend (H)	233	273	313	373	473	573
Height of moving end bracket ( $H_{MA}$ )	180	220	260	320	420	520
Safety margin (S)	30	30	30	30	30	30
Installation height ( $H_s$ )	263	303	343	403	503	603
Arc projection ( $M_L$ )	181	201	221	251	301	351

## POWERLINE PLASTIC CROSSBAR



The crossbars connect the two side runs of the energy chain.  
The crossbar length is synonymous with the inside width of the energy chain.

Type	Order No.	Description	Inside width mm
RS 045-5	052004500000	Crossbar	45.0
RS 057-5	052005700000	Crossbar	57.0
RS 062-5	052006200000	Crossbar	62.0
RS 071-5	052007100000	Crossbar	71.0
RS 084-5	052008400000	Crossbar	84.0
RS 093-5	052009300000	Crossbar	93.0
RS 096-5	052009600000	Crossbar	96.0
RS 104-5	052010400000	Crossbar	104.0
RS 107-5	052010700000	Crossbar	107.0
RS 121-5	052012100000	Crossbar	121.0
RS 133-5	052013300000	Crossbar	133.0
RS 144-5	052014400000	Crossbar	144.0
RS 146-5	052014600000	Crossbar	146.0
RS 158-5	052015800000	Crossbar	158.0
RS 164-5	052016400000	Crossbar	164.0
RS 171-5	052017100000	Crossbar	171.0
RS 182-5	052018200000	Crossbar	182.0
RS 196-5	052019600000	Crossbar	196.0
RS 208-5	052020800000	Crossbar	208.0
RS 220-5	052022000000	Crossbar	220.0
RS 233-5	052023300000	Crossbar	233.0
RS 246-5	052024600000	Crossbar	246.0
RS 252-5	052025200010	Crossbar	252.0
RS 258-5	052025800000	Crossbar	258.0
RS 296-5	052029600000	Crossbar	296.0
RS 346-5	052034600000	Crossbar	346.0
RS 350-5	052035000000	Crossbar	350.0
RS 358-5	052035800000	Crossbar	358.0
RS 371-5	052037100000	Crossbar	371.0
RS 396-5	052039600000	Crossbar	396.0
RS 421-5	052042100000	Crossbar	421.0
RS 446-5	052044600000	Crossbar	446.0
RS 496-5	052049600000	Crossbar	496.0
RS 546-5	052054600000	Crossbar	546.0

**KA 32 CHAIN BRACKET FLEXIBLE**

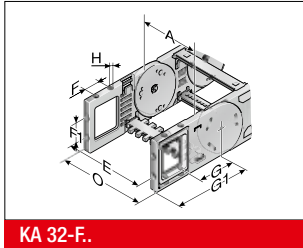

KA 32-F.

This chain bracket offers universal connection options (top, bottom and front) and is attached to the ends of the chain like a side link. This allows the chain to move right up to the bracket. Each chain requires one male and one female bracket. M5 bolts are used to secure the brackets in place. Extrusion-coated metal bushes with either a through-hole (-FB) or a threaded hole (-FG) ensure the permanent, high-strength transmission of even extreme forces onto the energy chain.

Type	Order No.	Material	Version	Inside width								Outside width of KA 0 mm
				A mm	E mm	F mm	F1 mm	G mm	G1 mm	H mm	H0 mm	
KA 32-FB	0321000054	Plastic	with bush	45.0 – 546.0	A+14.0	22.5	22.0	57.8	95.5	95.5	5.5	A+28.0
KA 32-FG	0321000055	Plastic	with thread	45.0 – 546.0	A+14.0	22.5	22.0	57.8	95.5	M5		A+28.0

**MP 32.2 SLIDING BLOCK**

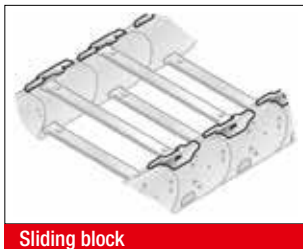

Sliding block

In the case of energy chains, sliding blocks are used in a horizontally sliding installation mode (the tight side of the chain slides on the slack side). The sliding blocks are set onto the side links on the interior bend instead of the usual crossbar interlocks; (no tools needed). This forces the chain to slide on the sliding blocks instead on the side links of the chain. Depending on the application, the service life of the energy chain may be extended five-fold, by using slide blocks. Information about the minimum bending radius of the energy chain at the sliding block insert is listed in the following table.

Type	Order No.	Min. radius mm	Sliding block height mm
GS 32.2	032290400300	120.0	4.0

**TR 32 SEPARATOR**

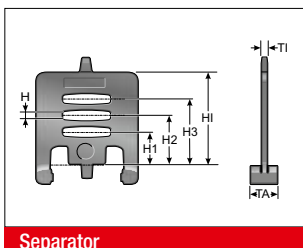

Separator

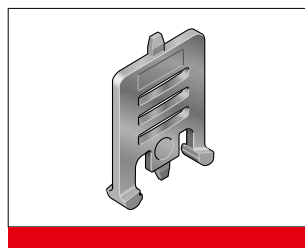

We recommend that separators be used if multiple round cables or conduits with differing diameters are to be installed.

Type	Order No.	Description	Version	T1 mm	TA mm	H mm	H1 mm	H2 mm	H3 mm	Hl mm
TR 32	032000009200	Separator	lockable	3.0	10.0	4.2	10.4	16.2	22.0	32.0

**TR 32.1 SEPARATOR**

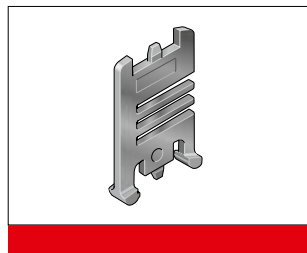
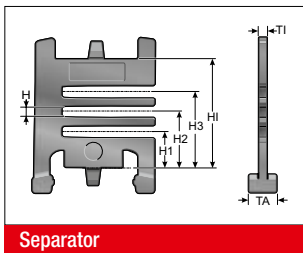

We recommend that separators be used if multiple round cables or conduits with differing diameters are to be installed.

Separator

Type	Order No.	Description	Version	TI mm	TA mm	H mm	H1 mm	H2 mm	H3 mm	H4 mm
TR 32.1	032200009200	Separator	lockable	3.5	8.0	4.0	10.5	16.5	22.5	32.0

**RTT 32 SHELF SUPPORT, DIVISIBLE**

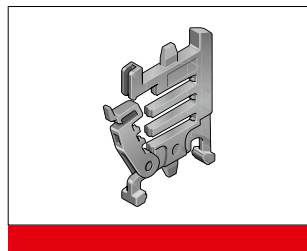
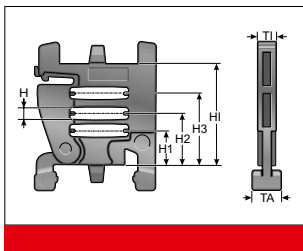

In connection with two separable shelf supports (RTT) with at least one end-to-end shelf (RB) the shelf becomes an easy to fill shelving system. The additional levels prevent cables from criss-crossing and minimise the friction between them.

Type	Order No.	Description	Version	TI mm	TA mm	H mm	H1 mm	H2 mm	H3 mm	H4 mm
RTT 32	100090322000	Shelf support, divisible	lockable	7.0	8.0	4.0	10.5	16.5	22.5	32.0

**RB-5 SHELF**

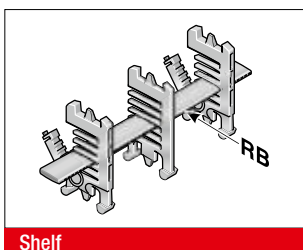

Shelf

In connection with at least two separable shelf supports (RTT), the shelf becomes a shelving system. The additional levels prevent cables from criss-crossing and minimise the friction between them.

Type	Order No.	Description	Width mm	Inside width mm
RB 028-5	100000002800	Shelf	28.0	45.0
RB 034-5	1000003405	Shelf	33.6	45.0
RB 039-5	1000003905	Shelf	39.2	45.0
RB 045-5	1000004505	Shelf	44.8	57.0
RB 050-5	1000005005	Shelf	50.4	57.0

**RB-5 SHELF**

Type	Order No.	Description	Width mm	Inside width mm
RB 056-5	10000005601	Shelf	56.0	62.0
RB 062-5	1000006205	Shelf	61.6	62.0
RB 067-5	1000006705	Shelf	67.2	84.0
RB 073-5	1000007305	Shelf	72.8	84.0
RB 078-5	1000007805	Shelf	78.4	84.0
RB 084-5	10000008400	Shelf	84.0	84.0
RB 090-5	1000009005	Shelf	89.6	96.0
RB 095-5	1000009505	Shelf	95.2	96.0
RB 101-5	1000010105	Shelf	100.8	107.0
RB 106-5	1000010605	Shelf	106.4	107.0
RB 112-5	100000011200	Shelf	112.0	121.0
RB 118-5	1000011805	Shelf	117.6	121.0
RB 123-5	1000012305	Shelf	123.2	133.0
RB 129-5	1000012905	Shelf	128.8	133.0
RB 134-5	1000013405	Shelf	134.4	144.0
RB 140-5	100000014000	Shelf	140.0	144.0
RB 146-5	1000014605	Shelf	145.6	158.0
RB 151-5	1000015105	Shelf	151.2	158.0
RB 157-5	1000015705	Shelf	156.8	164.0
RB 162-5	1000016205	Shelf	162.4	164.0
RB 168-5	100000016800	Shelf	168.0	182.0
RB 174-5	1000017405	Shelf	173.6	182.0
RB 179-5	1000017905	Shelf	179.2	196.0
RB 185-5	1000018505	Shelf	184.8	196.0
RB 190-5	1000019005	Shelf	190.4	196.0
RB 196-5	100000019600	Shelf	196.0	196.0
RB 291-5	100000029100	Shelf	291.2	346.0

**RSV 32 CROSSBAR CONNECTOR**

For crossbars wider than 246 mm, we recommend the use of crossbar connectors. These prevent deformation to the crossbar under large amounts of additional weight of the chain assembly.

Type	Order No.	Description	TI mm
RSV 32	032000009600	Crossbar connector	7.5
RSV 32 Alu	032000009800	Crossbar connector for aluminium crossbars	7.5

**RE 32 H-SHAPED SHELF UNIT**

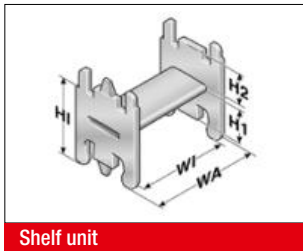

One-piece shelving system, the shelf cannot be varied in height.

Type	Order No.	Description	WA mm	WI mm	H1 mm	H2 mm	HI mm
RE 32/35	100000322010	H-shaped shelf unit	43.2	35.2	14.2	14.2	32.4
RE 32/52	100000323510	H-shaped shelf unit	60.0	52.0	14.2	14.2	32.4
RE 32/75	100000327510	H-shaped shelf unit	82.4	74.4	16.4	12.0	32.4

**BS-5 BRACKET BAR**



Large-diameter conduits are routed securely by using a bracket bar (BS). This bar is installed on the crossbars or the covers of the energy chain.

The bracket bar can be installed on both the inside and outside bend.

The bracket bar support (BSH) is used to attach the bars to PowerLine series crossbars. Two bracket bar supports are required for each bar.

Type	Order No.	Description	Conduit diameter max. mm	Installation height mm	Inner chain width min. mm
BS 120-5	052412000000	Bracket bar	115.0	140.0	164.0
BS 153-5	052415300000	Bracket bar	148.0	170.0	208.0
BS 187-5	052418700000	Bracket bar	182.0	205.0	233.0
BSH-5	052400000000	Bracket bar support			
Assembly set	052400000001	Assembly set			

**D3 CHAIN BRACKET COVER**



Self-locking covers close the side mounting window on the flexible chain bracket (KA-FB/FG).

Type	Order No.
Cover D3 KA 32.1-FB/FG	0323888002

**MP 32.3 CHAIN BRACKET CANOPY**



Constructed from aluminium, the canopies for the flexible chain bracket (KA-FB/FG) ensure a continuously closed system for chains with covers.

**Canopy for chain bracket fixed point outside bend: Type and order number configurator**



Type:	KA 32.1 FB/FG AB	Inside width	2-2
Order No.:	0321	Inside width	060

**Canopy for chain bracket fixed point inside bend: Type and order number configurator**



Type:	KA 32.1 FB/FG IB	Inside width	2-2
Order No.:	0321	Inside width	058

**Canopy for chain bracket moving end outside bend: Type and order number configurator**



Type:	KA 32.1 FB/FG AB	Inside width	1-2
Order No.:	0321	Inside width	059

**Canopy for chain bracket moving end inside bend: Type and order number configurator**

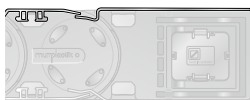

Type:	KA 32.1 FB/FG IB	Inside width	1-2
Order No.:	0321	Inside width	057

**Ordering example:**

0321096058 KA 32.1 FB/FG IB 096 2-2

Chain bracket canopy at fixing point in inside bend, for inside width of 96 mm.

**RS-ZL-5 CROSSBAR STRAIN RELIEF PLATE**

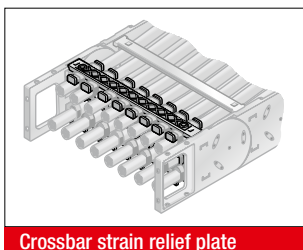

Fixed integrated frame bridge strain relief plates in the chain brackets. Tailored to all crossbar widths up to 246 mm. May be assembled on the inside and outside bends at both chain endings.

Type	Order No.	Description	Inside width mm
RS-ZL 045-5	052004500010	Crossbar strain relief plate	45.0
RS-ZL 057-5	052005700010	Crossbar strain relief plate	57.0
RS-ZL 062-5	052006200010	Crossbar strain relief plate	62.0
RS-ZL 071-5	052007100010	Crossbar strain relief plate	71.0
RS-ZL 084-5	052008400010	Crossbar strain relief plate	84.0
RS-ZL 093-5	052009300010	Crossbar strain relief plate	93.0
RS-ZL 096-5	052009600010	Crossbar strain relief plate	96.0



**RS-ZL-5 CROSSBAR STRAIN RELIEF PLATE**

Type	Order No.	Description	Inside width mm
RS-ZL 104-5	052010400010	Crossbar strain relief plate	104.0
RS-ZL 107-5	052010700010	Crossbar strain relief plate	107.0
RS-ZL 121-5	052012100010	Crossbar strain relief plate	121.0
RS-ZL 133-5	052013300010	Crossbar strain relief plate	133.0
RS-ZL 144-5	052014400010	Crossbar strain relief plate	144.0
RS-ZL 146-5	052014600010	Crossbar strain relief plate	146.0
RS-ZL 158-5	052015800010	Crossbar strain relief plate	158.0
RS-ZL 164-5	052016400010	Crossbar strain relief plate	164.0
RS-ZL 171-5	052017100010	Crossbar strain relief plate	171.0
RS-ZL 182-5	052018200010	Crossbar strain relief plate	182.0
RS-ZL 196-5	052019600010	Crossbar strain relief plate	196.0
RS-ZL 208-5	052020800010	Crossbar strain relief plate	208.0
RS-ZL 220-5	052022000010	Crossbar strain relief plate	220.0
RS-ZL 233-5	052023300010	Crossbar strain relief plate	233.0
RS-ZL 246-5	052024600010	Crossbar strain relief plate	246.0

**STRAIN RELIEF WITH STEEL FIX**

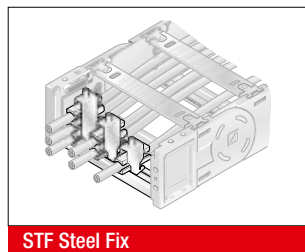
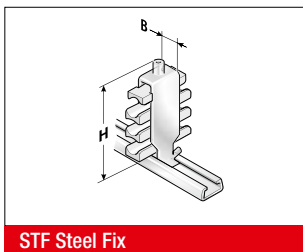

C-rails (galvanised) for permanent integration, for accommodating the Steel Fix bow clamps in the chain brackets. The bow clamps can take up to 3 cables and are suitable for C-rails with a groove width of 11 mm. Due to the design of the trough elements, a cable preserving cable guidance is ensured. May be assembled on the inside and outside bends at both chain endings. The overall height stated is a guide only. The actual height is, amongst other things, dependent on the diameter and the quality of the cable. A safety distance of 10 mm at the fixed point above the strain relief must be kept during gliding applications.

Type	Order No.	Description	Seats qty.	Cable Ø mm	Width mm	Total height (H) mm
<b>Single clamp (for one cable)</b>						
STF 12-1 Steel Fix	81661801	Hooped clamp	1	6.0 – 12.0	16.0	55.0
STF 14-1 Steel Fix	81661802	Hooped clamp	1	12.0 – 14.0	18.0	52.0
STF 16-1 Steel Fix	81661803	Hooped clamp	1	14.0 – 16.0	20.0	54.0
STF 18-1 Steel Fix	81661804	Hooped clamp	1	16.0 – 18.0	22.0	56.0
STF 20-1 Steel Fix	81661805	Hooped clamp	1	18.0 – 20.0	24.0	59.0
STF 22-1 Steel Fix	81661806	Hooped clamp	1	20.0 – 22.0	26.0	61.0
STF 26-1 Steel Fix	81661807	Hooped clamp	1	22.0 – 26.0	30.0	70.0
STF 30-1 Steel Fix	81661808	Hooped clamp	1	26.0 – 30.0	34.0	74.0
STF 34-1 Steel Fix	81661809	Hooped clamp	1	30.0 – 34.0	38.0	78.0
STF 38-1 Steel Fix	81661810	Hooped clamp	1	34.0 – 38.0	42.0	82.0
STF 42-1 Steel Fix	81661811	Hooped clamp	1	38.0 – 42.0	46.0	91.0

**STRAIN RELIEF WITH STEEL FIX**

Type	Order No.	Description	Seats qty.	Cable Ø mm	Width mm	Total height (H) mm
<b>Double clamp (for two cables)</b>						
STF 12-2 Steel Fix	81661821	Hooped clamp	2	6.0 – 12.0	16.0	73.0
STF 14-2 Steel Fix	81661822	Hooped clamp	2	12.0 – 14.0	18.0	74.0
STF 16-2 Steel Fix	81661823	Hooped clamp	2	14.0 – 16.0	20.0	82.0
STF 18-2 Steel Fix	81661824	Hooped clamp	2	16.0 – 18.0	22.0	86.0
STF 20-2 Steel Fix	81661825	Hooped clamp	2	18.0 – 20.0	24.0	91.0
STF 22-2 Steel Fix	81661826	Hooped clamp	2	20.0 – 22.0	26.0	95.0
STF 26-2 Steel Fix	81661827	Hooped clamp	2	22.0 – 26.0	30.0	108.0
STF 30-2 Steel Fix	81661828	Hooped clamp	2	26.0 – 30.0	34.0	121.0
STF 34-2 Steel Fix	81661829	Hooped clamp	2	30.0 – 34.0	38.0	129.0
<b>Triple clamp (for three cables)</b>						
STF 12-3 Steel Fix	81661841	Hooped clamp	3	6.0 – 12.0	16.0	98.0
STF 14-3 Steel Fix	81661842	Hooped clamp	3	12.0 – 14.0	18.0	98.0
STF 16-3 Steel Fix	81661843	Hooped clamp	3	14.0 – 16.0	20.0	105.0
STF 18-3 Steel Fix	81661844	Hooped clamp	3	16.0 – 18.0	22.0	111.0
STF 20-3 Steel Fix	81661845	Hooped clamp	3	18.0 – 20.0	24.0	118.0
STF 22-3 Steel Fix	81661846	Hooped clamp	3	20.0 – 22.0	26.0	130.0

**MP 32/41 LOCK BUTTON**

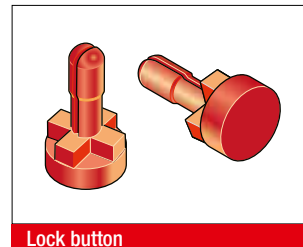
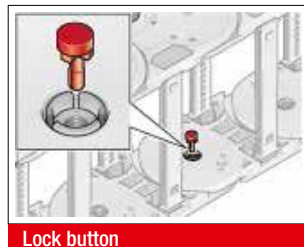
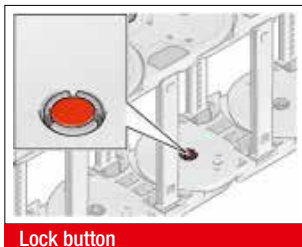

To increase the side stability, we recommend the use of lock buttons during strong lateral acceleration or when installed

“laying on the side (turned 90°) without support”.

Type	Order No.
MP32/41 lock button	041000008000

**MP 32 LOWERED FIXING POINT**

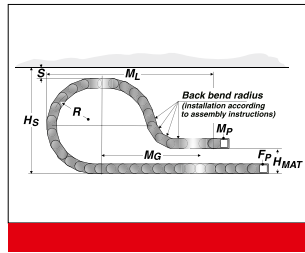
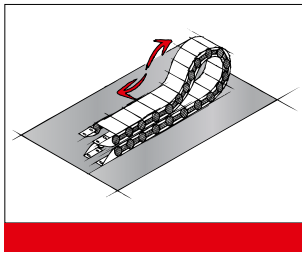

It is sometimes necessary to lower the height of the moving attachment point.

In such cases, modifications to the chain layout should be noted (e.g. extension of chain).

Please contact our application engineers.

Radius R mm	Height of moving end bracket (H <sub>MA</sub> ) mm	Safety margin (S) mm	Installation height incl. safety (H <sub>s</sub> ) mm	Projection (M <sub>1</sub> ) mm	Additional links qty.	of which additional back chain links qty.
200.0	210.0	50.0	523.0	720.0	14	3
250.0	230.0	50.0	623.0	880.0	17	3

**MP 32.2 REARWARD RADII**

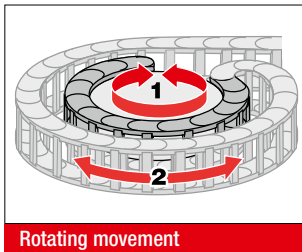

Rotating movement

Side links with rearward radius allow movements in both directions. This is intended for rotating movements and lowered chain brackets. Rotation movements are only possible with open variants.

Type	Order No.	Radius mm	Rearward radius mm
SR 32.2 RK080 (RÜ200/R120)	032200008060	120.0	200.0
SR 32.2 RK100 (RÜ200/R135)	032200010060	135.0	200.0
SR 32.2 RK120 (RÜ200/R150)	032200012060	150.0	200.0
SR 32.2 RK150 (RÜ200/R170)	032200015060	170.0	200.0
SR 32.2 RK200 (RÜ200/R200)	032200020060	200.0	200.0
SR 32.2 RK250 (RÜ200/R250)	032200025060	250.0	200.0

**GUIDE CHANNEL VAW (ALUMINIUM / STAINLESS STEEL)**



VAW steel galvanised / stainless steel

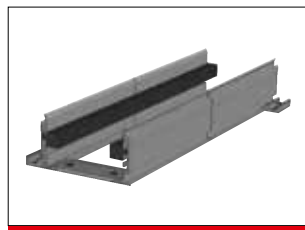

VAW aluminium

A range of variable guide channel systems, constructed from aluminium or stainless steel sections, are available for this energy chain.

The variable guide channel ensures that the energy chain is supported and guided securely.

**ASSEMBLY INSTRUCTION FLEXIBLE CHAIN BRACKET FB/FG**

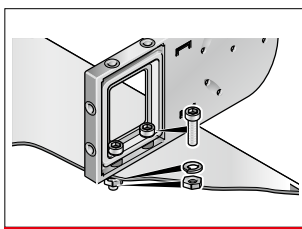

FB chain bracket

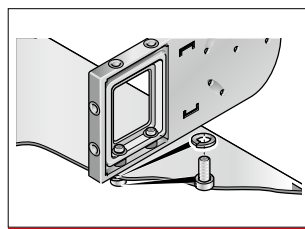

Chain bracket FG

Brass bushes guarantee long-lasting fastening without cold flow in the plastic.

**Version KA-FB:**

Integrated through-hole fastened down using screw and nut.

**Version KA-FG:**

Built-in threads allow for quick and easy on-site mounting, since a screw, including a retaining washer where necessary, is sufficient.

**ASSEMBLY**

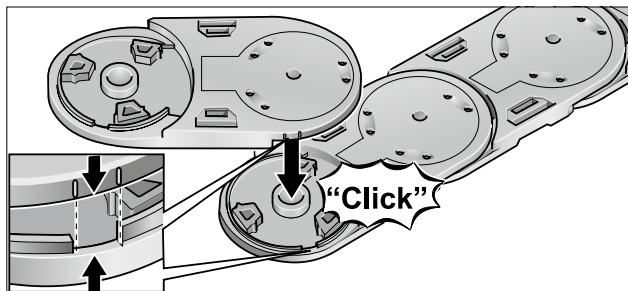

Step 1

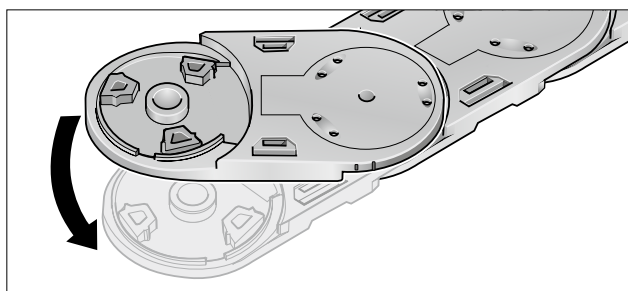

Step 2

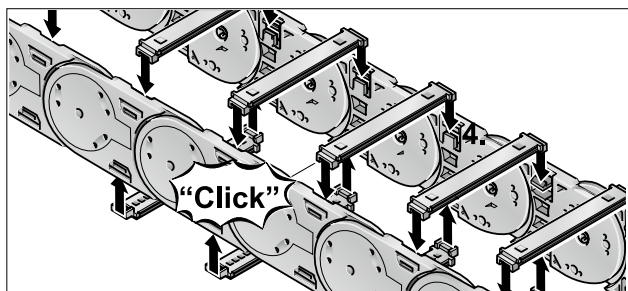

Step 3

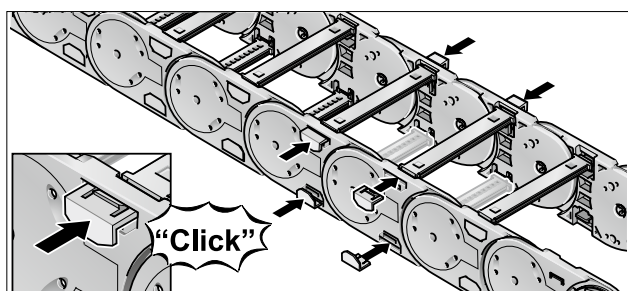

Step 4

**DISASSEMBLY**

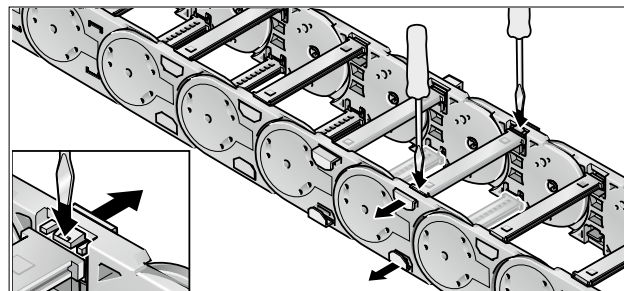

Step 1

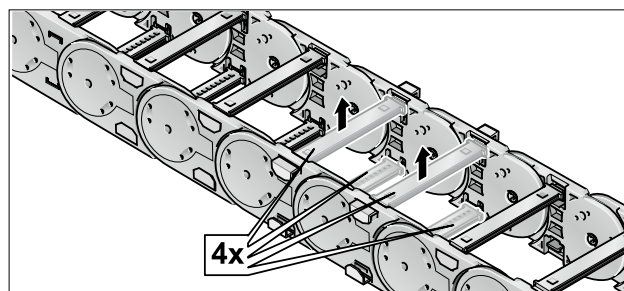

Step 2

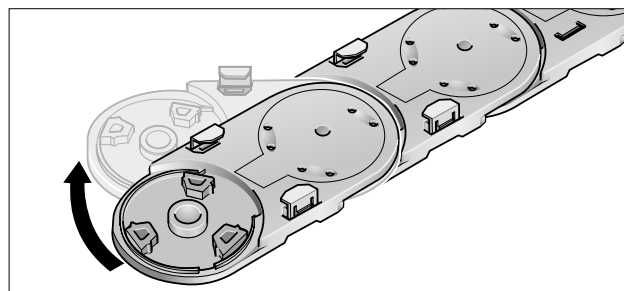

Step 3

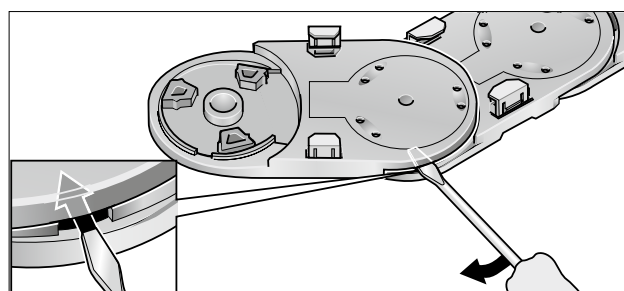

Step 4



**MP 41.2**  
OPEN



**MP 41.3**  
CLOSED

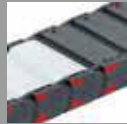

- SLIDING BLOCKS FOR LONGER SERVICE LIFE
- BROAD INTERIOR LAYOUT
- CHAIN BRACKET FLEXIBLE
- PLASTIC OR ALUMINIUM VERSION

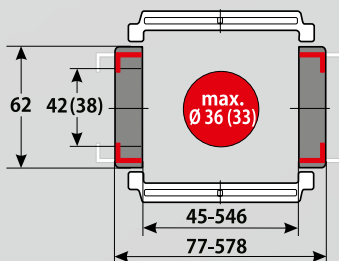

## TECHNICAL DATA

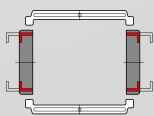

**Loading side**  
Inside and outside bend

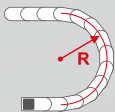

**Available radii**  
90.0 – 350.0 mm

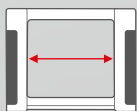

**Available interior widths**  
With plastic crossbar  
45.0 – 546.0 mm  
With alu crossbar / with alu cover  
67.0 – 600.0 mm / 43.0 – 600.0 mm

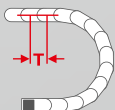

**Pitch**  
T = 77.0 mm



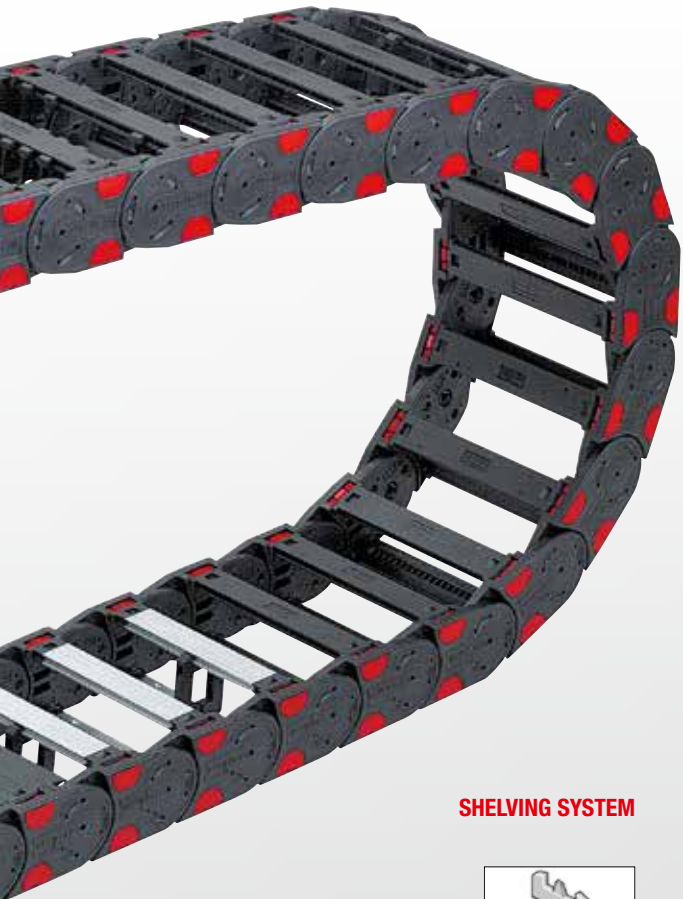

## TECHNICAL SPECIFICATIONS

Travel distance gliding $L_g$ max.	120.0 m
Travel distance self-supporting $L_s$ max.	see diagram on page 205
Travel distance vertical, hanging $L_{vh}$ max.	50.0 m
Travel distance vertical, upright $L_{vs}$ max.	6.0 m
Rotated 90°, unsupported $L_{90f}$ max.	1.0 m
Speed, gliding $V_g$ max.	5.0 m/s
Speed, self-supporting $V_s$ max.	20.0 m/s
Acceleration, gliding $a_g$ max.	25.0 m/s <sup>2</sup>
Acceleration, self-supporting $a_s$ max.	30.0 m/s <sup>2</sup>

Contact our engineering department to meet any higher requirements: [efk@murrplastik.de](mailto:efk@murrplastik.de)

## MATERIAL PROPERTIES

Standard material	Polyamide (PA) black
Service temperature	-30.0 – 120.0 °C
Gliding friction factor	0.3
Static friction factor	0.45
Fire classification	UL 94 HB

Other material properties on request.

## ACCESSORIES

### SHELVING SYSTEM



Separator TR

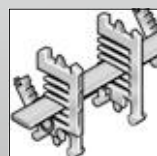

RS shelving system



Crossbar connector RSV

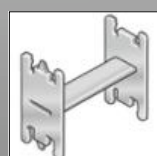

H-shaped shelf unit RE

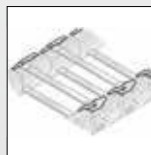

Sliding block

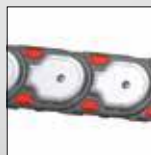

Gliding plate



Bracket bar



Cover

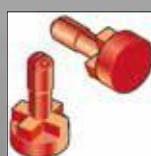

Lock button

### CHAIN BRACKET

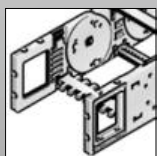

Chain bracket flexible

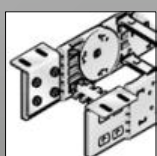

Chain bracket angle

### GUIDE CHANNELS



VAW steel galvanised / stainless steel



VAW aluminium

### STRAIN RELIEF



RS-ZL crossbar strain relief

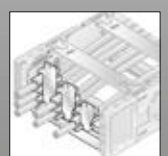

STF Steel Fix

**ORDERING KEY**

Dimensions in mm [US inch]

Type code	Variation	Inside width	Outside width	Inside width	Outside width	Radius	Crossbar variant	Material	Chain length
0412 30	MP 41.2 open Crossbar on outside bend Crossbar on inside bend Opens on inside and outside bend	045 <sup>1)</sup> [1.77]	077 [3.03]	233 [9.17]	265 [10.43]	090 <sup>1)</sup> [3.54]	0 Plastic, full-ridged with bias	0 Polyamide standard (PA/black)	
		057 <sup>1)</sup> [2.24]	089 [3.50]	246 <sup>2)</sup> [9.69]	278 <sup>2)</sup> [10.94]				
0413 44 <sup>3)</sup>	MP 41.3 Closed Cover on outside bend Cover on inside bend Opens on inside and outside bend	062 <sup>1)</sup> [2.44]	094 [3.70]	252 [9.92]	284 [11.18]	120 <sup>1)</sup> [4.72]	1 Plastic, full-ridged without bias	5 Polypropylene (PP/blue)	
		071 [2.80]	103 [4.06]	258 [10.16]	290 [11.42]				
		084 <sup>2)</sup> [3.31]	116 <sup>2)</sup> [4.57]	296 <sup>2)</sup> [11.65]	328 <sup>2)</sup> [12.91]	150 [5.91]	2 Plastic, half-ridged with bias	7 EMC (PA/light grey)	
		093 [3.66]	125 [4.92]	346 [13.62]	378 [14.88]				
		096 <sup>2)</sup> [3.78]	128 <sup>2)</sup> [5.04]	350 [13.78]	382 [15.04]	175 [6.89]	3 Plastic, half-ridged without bias	9 Special version (on request)	
		104 [4.09]	136 [5.35]	358 [14.09]	390 [15.35]				
		107 [4.21]	139 [5.47]	371 [14.61]	403 [15.87]	200 [7.87]	4 Aluminium full-ridged with bias		
		121 <sup>2)</sup> [4.76]	153 <sup>2)</sup> [6.02]	396 [15.59]	428 [16.85]				
		133 [5.24]	165 [6.50]	421 [16.57]	453 [17.83]	250 [9.84]	5 Aluminium full-ridged without bias		
		144 [5.67]	176 [6.93]	446 [17.56]	478 [18.82]				
		146 <sup>2)</sup> [5.75]	178 <sup>2)</sup> [7.01]	496 [19.53]	528 [20.79]	300 [11.81]	6 Aluminium half-ridged with bias		
		158 [6.22]	190 [7.48]	546 [21.50]	578 [22.76]				
		164 [6.46]	196 [7.72]			350 [13.78]	7 Aluminium half-ridged without bias		
		171 <sup>2)</sup> [6.73]	203 <sup>2)</sup> [7.99]						
		182 <sup>2)</sup> [7.17]	214 <sup>2)</sup> [8.43]				9 Special version (on request)		
		196 <sup>2)</sup> [7.72]	228 <sup>2)</sup> [8.98]						
		208 [8.19]	240 [9.45]						
		220 [8.66]	252 [9.92]						



**ORDERING EXAMPLE: 0412 30 045 090 0 0 1386**

Crossbar on outside bend, crossbar on inside bend, can be opened from inside and outside bend  
 Inside width 45 mm; radius 90 mm  
 Plastic crossbar, full-ridged with bias, material black-coloured polyamide  
 Chain length 1386 mm (18 links)

- <sup>1)</sup> for Variant 30 only
- <sup>2)</sup> also available with plastic cover
- <sup>3)</sup> Reduced inner height, reduced max. cable diameter, see chain window drawing on previous page



**NOTE ON CONFIGURATION**

**Aluminium crossbars:**

Aluminium crossbars can be supplied in 1 mm width sizes for inner widths from 67.0 mm – 600.0 mm .

**Aluminium covers:**

Aluminium covers can be supplied in 1 mm width sizes for inner widths from 43.0 mm – 600.0 mm .

**Crossbar connector and crossbar strain relief plate:**

Once inside widths exceed 246 mm, we recommend the deployment of crossbar connectors (RSV). Crossbar connectors cannot be used in conjunction with covers made from plastic or aluminium.

If crossbar strain relief plates (RS-ZL) are to be deployed in the chain brackets, take standard inside widths into account.

For detailed information, please consult the corresponding product documentation.

**SELF-SUPPORTING LENGTH**

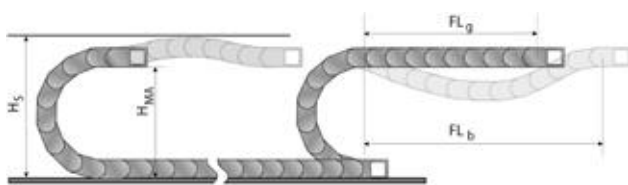

The self-supporting length is the distance between the chain bracket on the moving end and the start of the chain arch. The installation variant  $FL_g$  offers the lowest load and wear for the energy chain. The maximum travel parameters (speed and acceleration) can be applied for this variant.

- $H_s$  = Installation height plus safety
- $H_{MA}$  = Height of moving end connection
- $FL_g$  = Self-supporting length, upper run straight
- $FL_b$  = Self-supporting length, upper run bent

**LOAD DIAGRAM FOR SELF-SUPPORTING APPLICATIONS**

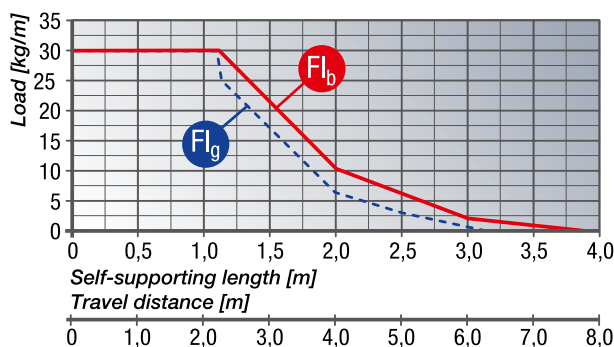

**$FL_g$  Self-supporting length, upper run straight**

In the  $FL_g$  range, the chain upper run still has a bias, is straight or has a maximum sag of 70.0 mm.

**$FL_b$  Self-supporting length, upper run bent**

In the  $FL_b$  range, the chain upper run has a sag of more than 70.0 mm, but this is still less than the maximum sag. Where the sag is greater than that permitted in the  $FL_b$  range, the application is critical and should be avoided. The self-supporting length can be optimised by using a support for the upper run or a more stable energy chain. Closed energy chains (with covers) have a higher unit weight than open chains (with crossbars). This higher weight must be taken into account when calculating the self-supporting length. To the weight of the cabling (cable load, in kg/m), you must add 1.5 kg/m, to account for the higher weight of closed-cover chains.

**DETERMINING THE CHAIN LENGTH**

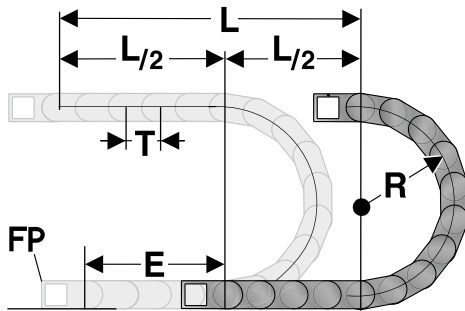

The fixed point of the energy chain should be connected in the middle of the travel distance. This arrangement gives the shortest connection between the fixed point (FP) and the moving consumer and thus the most efficient chain length.

Chain length calculation =  $L/2 + \pi * R + E$   
 $\approx 1 \text{ m chain} = 13 \text{ qty. x } 77.0 \text{ mm.}$

- E = Distance between entry point and middle of travel distance
- L = Travel distance
- R = Radius
- P = Pitch 77.0 mm

**INSTALLATION DIMENSIONS**

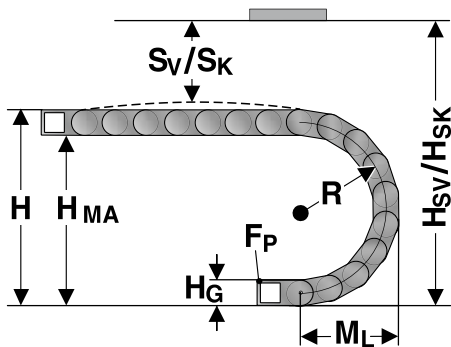

The moving end chain connection is to be screw fixed at height H<sub>MA</sub> for the respective radius. Concerning the installed dimensions, you must take into account whether the chain links are equipped with or without bias. For chain links without bias, the “Installed height without bias H<sub>SK</sub>” value has to be taken into account. If the chain links are equipped with a bias, the value “Installed height with bias H<sub>sv</sub>” has to be taken into account.

Radius R	90	120	150	175	200	250	300	350
Outside height of chain link (H <sub>G</sub> )	62	62	62	62	62	62	62	62
Height of bend (H)	252	312	372	422	472	572	672	772
Height of moving end bracket (H <sub>MA</sub> )	190	250	310	360	410	510	610	710
Safety margin with bias (S <sub>v</sub> )	30	30	30	30	30	30	30	30
Installation height with bias (H <sub>sv</sub> )	282	342	402	452	502	602	702	802
Safety margin without bias (S <sub>k</sub> )	15	15	15	15	15	15	15	15
Installation height without bias (H <sub>sk</sub> )	267	327	387	437	487	587	687	787
Arc projection (M <sub>L</sub> )	203	233	263	288	313	363	413	463

## POWERLINE PLASTIC CROSSBAR



The crossbars connect the two side runs of the energy chain.  
The crossbar length is synonymous with the inside width of the energy chain.

Type	Order No.	Description	Inside width mm
RS 045-5	052004500000	Crossbar	45.0
RS 057-5	052005700000	Crossbar	57.0
RS 062-5	052006200000	Crossbar	62.0
RS 071-5	052007100000	Crossbar	71.0
RS 084-5	052008400000	Crossbar	84.0
RS 093-5	052009300000	Crossbar	93.0
RS 096-5	052009600000	Crossbar	96.0
RS 104-5	052010400000	Crossbar	104.0
RS 107-5	052010700000	Crossbar	107.0
RS 121-5	052012100000	Crossbar	121.0
RS 133-5	052013300000	Crossbar	133.0
RS 144-5	052014400000	Crossbar	144.0
RS 146-5	052014600000	Crossbar	146.0
RS 158-5	052015800000	Crossbar	158.0
RS 164-5	052016400000	Crossbar	164.0
RS 171-5	052017100000	Crossbar	171.0
RS 182-5	052018200000	Crossbar	182.0
RS 196-5	052019600000	Crossbar	196.0
RS 208-5	052020800000	Crossbar	208.0
RS 220-5	052022000000	Crossbar	220.0
RS 233-5	052023300000	Crossbar	233.0
RS 246-5	052024600000	Crossbar	246.0
RS 252-5	052025200010	Crossbar	252.0
RS 258-5	052025800000	Crossbar	258.0
RS 296-5	052029600000	Crossbar	296.0
RS 346-5	052034600000	Crossbar	346.0
RS 350-5	052035000000	Crossbar	350.0
RS 358-5	052035800000	Crossbar	358.0
RS 371-5	052037100000	Crossbar	371.0
RS 396-5	052039600000	Crossbar	396.0
RS 421-5	052042100000	Crossbar	421.0
RS 446-5	052044600000	Crossbar	446.0
RS 496-5	052049600000	Crossbar	496.0
RS 546-5	052054600000	Crossbar	546.0

**MP 41.3 PLASTIC COVER**



The covers connect the two side runs of the energy chain. The cover length is synonymous with the inside width of the energy chain.

Type	Order No.	Description	Installation site	Inside width mm
A-413084, outside	041308410000	Cover	Outside bend	84.0
I-413084, inside	041308420000	Cover	Inside bend	84.0
A-413096, outside	041309610000	Cover	Outside bend	96.0
I-413096, inside	041309620000	Cover	Inside bend	96.0
A-413121, outside	041312110000	Cover	Outside bend	121.0
I-413121, inside	041312120000	Cover	Inside bend	121.0
A-413146, outside	041314610000	Cover	Outside bend	146.0
I-413146, inside	041314620000	Cover	Inside bend	146.0
A-413171, outside	041317110000	Cover	Outside bend	171.0
I-413171, inside	041317120000	Cover	Inside bend	171.0
A-413182, outside	041318210000	Cover	Outside bend	182.0
I-413182, inside	041318220000	Cover	Inside bend	182.0
A-413196, outside	041319610000	Cover	Outside bend	196.0
I-413196, inside	041319620000	Cover	Inside bend	196.0
A-413246, outside	041324610000	Cover	Outside bend	246.0
I-413246, inside	041324620000	Cover	Inside bend	246.0
A-413296, outside	041329610000	Cover	Outside bend	296.0
I-413296, inside	041329620000	Cover	Inside bend	296.0

**KA 41 CHAIN BRACKET FLEXIBLE**

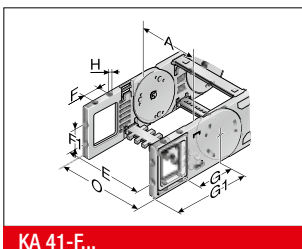

This chain bracket offers universal connection options (top, bottom and front) and is attached to the ends of the chain like a side link. This allows the chain to move right up to the bracket. Each chain requires one male and one female bracket. M6 bolts are used to secure the brackets in place. Extrusion-coated metal bushes with either a through-hole (-FB) or a threaded hole (-FG) ensure the permanent, high-strength transmission of even extreme forces onto the energy chain.

Type	Order No.	Material	Version	Inside width								Outside width of KA 0 mm
				A mm	E mm	F mm	F1 mm	G mm	G1 mm	H mm	H0 mm	
KA 41.1-FB	0411000054	Plastic	with bush	45.0 – 546.0	A+20.0	22.5	22.0	79.0	120.0	6.5	A+34.0	
KA 41.1-FG	0411000055	Plastic	with thread	45.0 – 546.0	A+20.0	22.5	22.0	79.0	120.0	M6	A+34.0	

**KA 41 CHAIN BRACKET ANGLE**

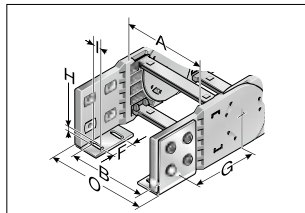

KA 41 (inside up / down)

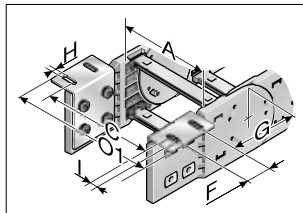

KA 41 (outside up / down)

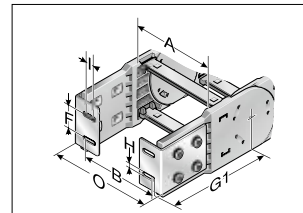

KA 41 (front inside)

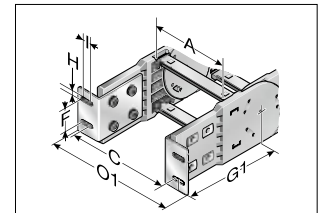

KA 41 (front outside)

There are several options regarding the chain bracket. The fixed-point bracket (inside/bottom) and the moving end bracket (inside/top) are supplied as standard. However, any other combination can be supplied upon request. The chain bracket is fas-

tened at the end like a side link. This enables the chain to move right up to the bracket. Each chain requires two chain brackets. The brackets should be fastened with M6 screws.

Type	Order No.	Material	Inside width							HØ mm	Outside width of KA 0 mm	Outside width of KA 01 mm
			A mm	B mm	C mm	F mm	G mm	G1 mm				
KA 41	0410000051	Sheet steel	45.0 – 546.0	A-2.5	A+34.5	32.0	79.0	125.7	6.5	A+32.0	A+71.0	

**MP 41.2 SLIDING BLOCK**

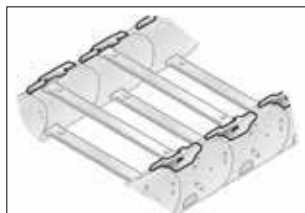

Sliding block

In the case of energy chains, sliding blocks are used in a horizontally sliding installation mode (the tight side of the chain slides on the slack side). The sliding blocks are set onto the side links on the interior bend instead of the usual crossbar interlocks; (no tools needed). This forces the chain to slide on the sliding blocks instead on the side links of the chain. Depending on the application, the service life of the energy chain may be extended five-fold, by using slide blocks. Information about the minimum bending radius of the energy chain at the sliding block insert is listed in the following table.

Type	Order No.	Min. radius mm	Sliding block height mm
GS 41.2	041290400300	120.0	4.0

**GLP 4 (41.2) GLIDING PLATE**

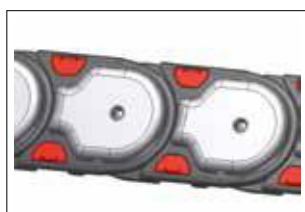

Gliding plate

The gliding plates are mounted in a horizontal position, with the chain laying on its side, to minimize friction wear to the sides. They are mounted to the side links using a special screw. The wear limit is 2.5 mm. We recommend replacing the energy chain when this limit has been reached. Depending on the application, the service life of the energy chain may be extended two-fold, by using gliding plates. The energy chain must be placed on its side before opening.

Type	Order No.	Installation site	For radius mm	Gliding plate height mm
SG 41.2 RK090 with GLP4, mounted	041200009064	Chain link including gliding plate	90.0	7.0
SG 41.2 RK120 with GLP4, mounted	041200012064	Chain link including gliding plate	120.0	7.0
SG 41.2 RK150 with GLP4, mounted	041200015064	Chain link including gliding plate	150.0	7.0
SG 41.2 RK175 with GLP4, mounted	041200017564	Chain link including gliding plate	175.0	7.0
SG 41.2 RK200 with GLP4, mounted	041200020064	Chain link including gliding plate	200.0	7.0
SG 41.2 RK250 with GLP4, mounted	041200025064	Chain link including gliding plate	250.0	7.0
SG 41.2 RK300 with GLP4, mounted	041200030064	Chain link including gliding plate	300.0	7.0
SG 41.2 RK350 with GLP4, mounted	041200035064	Chain link including gliding plate	350.0	7.0

**TR 41 SEPARATOR**

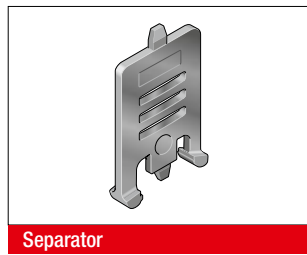
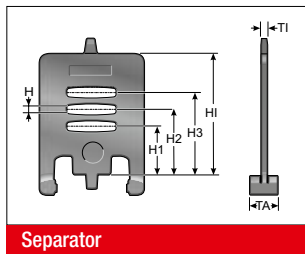

We recommend that separators be used if multiple round cables or conduits with differing diameters are to be installed.

Type	Order No.	Description	Version	TI mm	TA mm	H mm	H1 mm	H2 mm	H3 mm	HI mm
TR 41	041000009200	Separator	lockable	3.5	10.0	4.2	16.1	22.9	28.9	42.0

**TR 41.1 SEPARATOR**

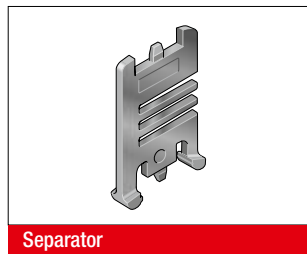
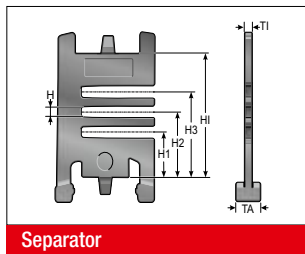

We recommend that separators be used if multiple round cables or conduits with differing diameters are to be installed.

Type	Order No.	Description	Version	TI mm	TA mm	H mm	H1 mm	H2 mm	H3 mm	HI mm
TR 41.1	041200009200	Separator	lockable	3.5	8.0	4.0	16.1	22.9	28.9	42.0

**TR 41-V SEPARATOR**

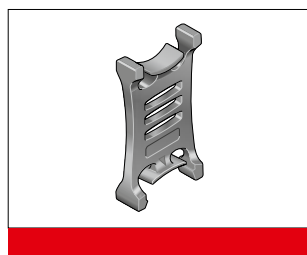
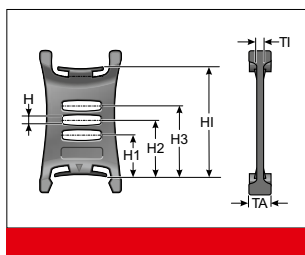

We recommend that separators be used if multiple round cables or conduits with differing diameters are to be installed.

Type	Order No.	Description	Version	TI mm	TA mm	H mm	H1 mm	H2 mm	H3 mm	HI mm
TR 41-V	041000009300	Separator	moveable	3.5	12.0	4.0	16.1	22.9	28.9	42.0

**RTT 41 SHELF SUPPORT, DIVISIBLE**

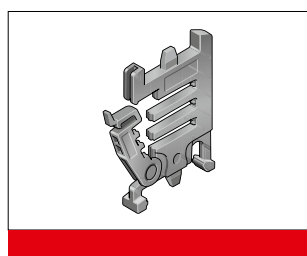
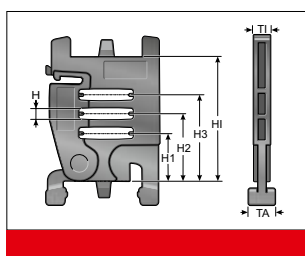

In connection with two separable shelf supports (RTT) with at least one end-to-end shelf (RB) the shelf becomes an easy to fill shelving system. The additional levels prevent cables from criss-crossing and minimise the friction between them.

Type	Order No.	Description	Version	TI mm	TA mm	H mm	H1 mm	H2 mm	H3 mm	HI mm
RTT 41	100090412000	Shelf support, divisible	lockable	7.0	8.0	4.0	16.1	22.9	28.9	42.0

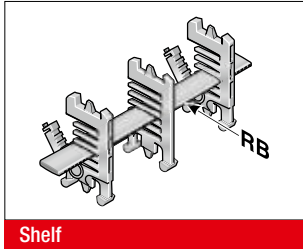
**RB-5 SHELF**

In connection with at least two separable shelf supports (RTT), the shelf becomes a shelving system. The additional levels prevent cables from criss-crossing and minimise the friction between them.

Type	Order No.	Description	Width mm	Inside width mm
RB 028-5	10000002800	Shelf	28.0	45.0
RB 034-5	1000003405	Shelf	33.6	45.0
RB 039-5	1000003905	Shelf	39.2	45.0
RB 045-5	1000004505	Shelf	44.8	57.0
RB 050-5	1000005005	Shelf	50.4	57.0
RB 056-5	10000005601	Shelf	56.0	62.0
RB 062-5	1000006205	Shelf	61.6	62.0
RB 067-5	1000006705	Shelf	67.2	84.0
RB 073-5	1000007305	Shelf	72.8	84.0
RB 078-5	1000007805	Shelf	78.4	84.0
RB 084-5	10000008400	Shelf	84.0	84.0
RB 090-5	1000009005	Shelf	89.6	96.0
RB 095-5	1000009505	Shelf	95.2	96.0
RB 101-5	1000010105	Shelf	100.8	107.0
RB 106-5	1000010605	Shelf	106.4	107.0
RB 112-5	100000011200	Shelf	112.0	121.0
RB 118-5	1000011805	Shelf	117.6	121.0
RB 123-5	1000012305	Shelf	123.2	133.0
RB 129-5	1000012905	Shelf	128.8	133.0
RB 134-5	1000013405	Shelf	134.4	144.0
RB 140-5	100000014000	Shelf	140.0	144.0
RB 146-5	1000014605	Shelf	145.6	158.0
RB 151-5	1000015105	Shelf	151.2	158.0
RB 157-5	1000015705	Shelf	156.8	164.0
RB 162-5	1000016205	Shelf	162.4	164.0
RB 168-5	100000016800	Shelf	168.0	182.0
RB 174-5	1000017405	Shelf	173.6	182.0
RB 179-5	1000017905	Shelf	179.2	196.0
RB 185-5	1000018505	Shelf	184.8	196.0
RB 190-5	1000019005	Shelf	190.4	196.0
RB 196-5	100000019600	Shelf	196.0	196.0
RB 291-5	100000029100	Shelf	291.2	346.0

### RSV 41 CROSSBAR CONNECTOR



For crossbars wider than 246 mm, we recommend the use of crossbar connectors. These prevent deformation to the crossbar under large amounts of additional weight of the chain assembly.

Type	Order No.	Description	T1 mm
RSV 41	041000009600	Crossbar connector	7.5
RSV 41 Alu	041000009800	Crossbar connector for aluminium crossbars	7.5

### MP 41 H-SHAPED SHELF UNIT

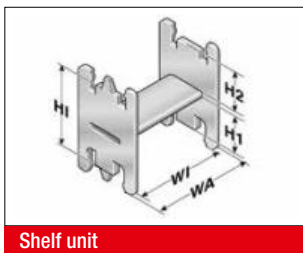

One-piece shelving system, the shelf cannot be varied in height.

Type	Order No.	Description	WA mm	WI mm	H1 mm	H2 mm	H3 mm
RE 36/11	100000361112	H-shaped shelf unit	42.5	36.5	26.2	11.5	42.0
RE 59/18	100000591812	H-shaped shelf unit	65.0	59.0	18.8	18.8	42.0
RE 81/11	100000811112	H-shaped shelf unit	87.5	81.5	26.2	11.5	42.0

### BS-5 BRACKET BAR



Large-diameter conduits are routed securely by using a bracket bar (BS). This bar is installed on the crossbars or the covers of the energy chain.

The bracket bar can be installed on both the inside and outside bend.

The bracket bar support (BSH) is used to attach the bars to PowerLine series crossbars. Two bracket bar supports are required for each bar.

Type	Order No.	Description	Conduit diameter max. mm	Installation height mm	Inner chain width min. mm
BS 120-5	052412000000	Bracket bar	115.0	140.0	164.0
BS 153-5	052415300000	Bracket bar	148.0	170.0	208.0
BS 187-5	052418700000	Bracket bar	182.0	205.0	233.0
BSH-5	052400000000	Bracket bar support			
Assembly set	052400000001	Assembly set			



**D4 CHAIN BRACKET COVER**

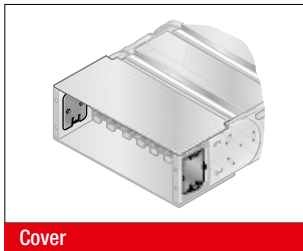

Self-locking covers close the side mounting window on the flexible chain bracket (KA-FB/FG).

Type	Order No.
D4 Cover	0413888002

**MP 41.3 CHAIN BRACKET CANOPY**

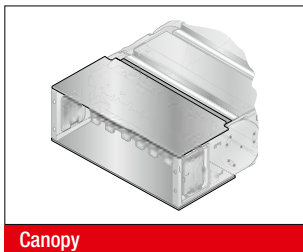

Constructed from aluminium, the canopies for the flexible chain bracket (KA-FB/FG) ensure a continuously closed system for chains with covers.

**Canopy for chain bracket fixed point outside bend: Type and order number configurator**



Type:	KA 41.1 FB/FG AB	Inside width	2-2
Order No.:	0411	Inside width	060

**Canopy for chain bracket fixed point inside bend: Type and order number configurator**



Type:	KA 41.1 FB/FG IB	Inside width	2-2
Order No.:	0411	Inside width	058

**Canopy for chain bracket moving end outside bend: Type and order number configurator**



Type:	KA 41.1 FB/FG AB	Inside width	1-2
Order No.:	0411	Inside width	059

**Canopy for chain bracket moving end inside bend: Type and order number configurator**



Type:	KA 41.1 FB/FG IB	Inside width	1-2
Order No.:	0411	Inside width	057

**The bestExample:**

0411096058 KA 41.1 FB/FG IB 096 2-2

Chain bracket canopy at fixing point in inside bend, for inside width of 96 mm.

**RS-ZL-5 CROSSBAR STRAIN RELIEF PLATE**

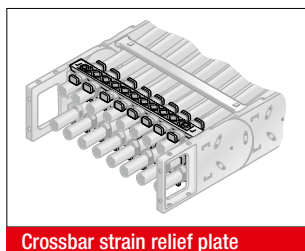

Fixed integrated frame bridge strain relief plates in the chain brackets. Tailored to all crossbar widths up to 246 mm. May be assembled on the inside and outside bends at both chain endings.

Type	Order No.	Description	Inside width mm
RS-ZL 045-5	052004500010	Crossbar strain relief plate	45.0
RS-ZL 057-5	052005700010	Crossbar strain relief plate	57.0
RS-ZL 062-5	052006200010	Crossbar strain relief plate	62.0
RS-ZL 071-5	052007100010	Crossbar strain relief plate	71.0
RS-ZL 084-5	052008400010	Crossbar strain relief plate	84.0
RS-ZL 093-5	052009300010	Crossbar strain relief plate	93.0
RS-ZL 096-5	052009600010	Crossbar strain relief plate	96.0
RS-ZL 104-5	052010400010	Crossbar strain relief plate	104.0
RS-ZL 107-5	052010700010	Crossbar strain relief plate	107.0
RS-ZL 121-5	052012100010	Crossbar strain relief plate	121.0
RS-ZL 133-5	052013300010	Crossbar strain relief plate	133.0
RS-ZL 144-5	052014400010	Crossbar strain relief plate	144.0
RS-ZL 146-5	052014600010	Crossbar strain relief plate	146.0
RS-ZL 158-5	052015800010	Crossbar strain relief plate	158.0
RS-ZL 164-5	052016400010	Crossbar strain relief plate	164.0
RS-ZL 171-5	052017100010	Crossbar strain relief plate	171.0
RS-ZL 182-5	052018200010	Crossbar strain relief plate	182.0
RS-ZL 196-5	052019600010	Crossbar strain relief plate	196.0
RS-ZL 208-5	052020800010	Crossbar strain relief plate	208.0
RS-ZL 220-5	052022000010	Crossbar strain relief plate	220.0
RS-ZL 233-5	052023300010	Crossbar strain relief plate	233.0
RS-ZL 246-5	052024600010	Crossbar strain relief plate	246.0

**MP 32/41 LOCK BUTTON**

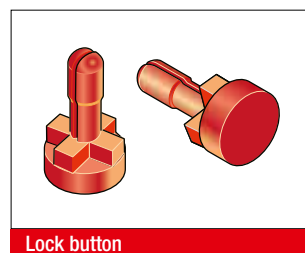
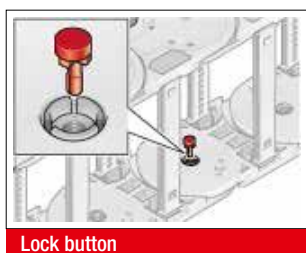
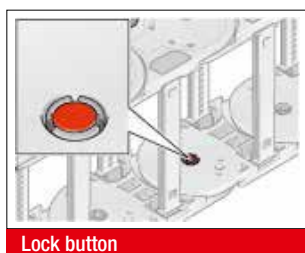

To increase the side stability, we recommend the use of lock buttons during strong lateral acceleration or when installed

“laying on the side (turned 90°) without support”.

Type	Order No.
MP32/41 lock button	041000008000

**STRAIN RELIEF WITH STEEL FIX**

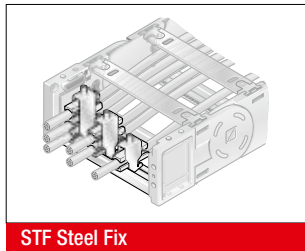
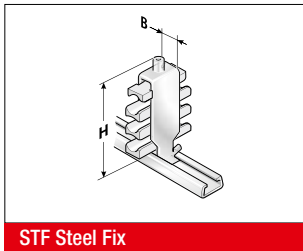

C-rails (galvanised) for permanent integration, for accommodating the Steel Fix bow clamps in the chain brackets. The bow clamps can take up to 3 cables and are suitable for C-rails with a groove width of 11 mm. Due to the design of the trough elements, a cable preserving cable guidance is ensured. May be assembled on the inside and outside bends at both chain endings. The overall height stated is a guide only. The actual height is, amongst other things, dependent on the diameter and the quality of the cable. A safety distance of 10 mm at the fixed point above the strain relief must be kept during gliding applications.

Type	Order No.	Description	Seats qty.	Cable Ø mm	Width mm	Total height (H) mm
<b>Single clamp (for one cable)</b>						
STF 12-1 Steel Fix	81661801	Hooped clamp	1	6.0 – 12.0	16.0	55.0
STF 14-1 Steel Fix	81661802	Hooped clamp	1	12.0 – 14.0	18.0	52.0
STF 16-1 Steel Fix	81661803	Hooped clamp	1	14.0 – 16.0	20.0	54.0
STF 18-1 Steel Fix	81661804	Hooped clamp	1	16.0 – 18.0	22.0	56.0
STF 20-1 Steel Fix	81661805	Hooped clamp	1	18.0 – 20.0	24.0	59.0
STF 22-1 Steel Fix	81661806	Hooped clamp	1	20.0 – 22.0	26.0	61.0
STF 26-1 Steel Fix	81661807	Hooped clamp	1	22.0 – 26.0	30.0	70.0
STF 30-1 Steel Fix	81661808	Hooped clamp	1	26.0 – 30.0	34.0	74.0
STF 34-1 Steel Fix	81661809	Hooped clamp	1	30.0 – 34.0	38.0	78.0
STF 38-1 Steel Fix	81661810	Hooped clamp	1	34.0 – 38.0	42.0	82.0
STF 42-1 Steel Fix	81661811	Hooped clamp	1	38.0 – 42.0	46.0	91.0
<b>Double clamp (for two cables)</b>						
STF 12-2 Steel Fix	81661821	Hooped clamp	2	6.0 – 12.0	16.0	73.0
STF 14-2 Steel Fix	81661822	Hooped clamp	2	12.0 – 14.0	18.0	74.0
STF 16-2 Steel Fix	81661823	Hooped clamp	2	14.0 – 16.0	20.0	82.0
STF 18-2 Steel Fix	81661824	Hooped clamp	2	16.0 – 18.0	22.0	86.0
STF 20-2 Steel Fix	81661825	Hooped clamp	2	18.0 – 20.0	24.0	91.0
STF 22-2 Steel Fix	81661826	Hooped clamp	2	20.0 – 22.0	26.0	95.0
STF 26-2 Steel Fix	81661827	Hooped clamp	2	22.0 – 26.0	30.0	108.0
STF 30-2 Steel Fix	81661828	Hooped clamp	2	26.0 – 30.0	34.0	121.0
STF 34-2 Steel Fix	81661829	Hooped clamp	2	30.0 – 34.0	38.0	129.0
<b>Triple clamp (for three cables)</b>						
STF 12-3 Steel Fix	81661841	Hooped clamp	3	6.0 – 12.0	16.0	98.0
STF 14-3 Steel Fix	81661842	Hooped clamp	3	12.0 – 14.0	18.0	98.0
STF 16-3 Steel Fix	81661843	Hooped clamp	3	14.0 – 16.0	20.0	105.0
STF 18-3 Steel Fix	81661844	Hooped clamp	3	16.0 – 18.0	22.0	111.0
STF 20-3 Steel Fix	81661845	Hooped clamp	3	18.0 – 20.0	24.0	118.0
STF 22-3 Steel Fix	81661846	Hooped clamp	3	20.0 – 22.0	26.0	130.0

**MP 41 LOWERED FIXING POINT**

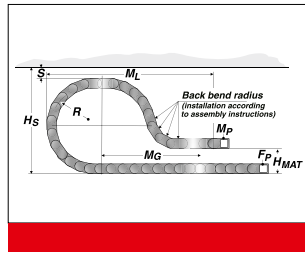
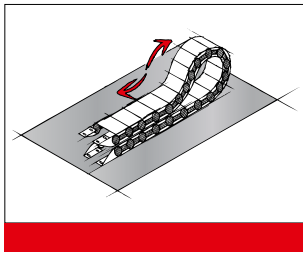

It is sometimes necessary to lower the height of the moving attachment point.

In such cases, modifications to the chain layout should be noted (e.g. extension of chain).

Please contact our application engineers.

Radius R mm	Height of moving end bracket (H <sub>MA</sub> ) mm	Safety margin (S) mm	Installation height incl. safety (H <sub>S</sub> ) mm	Projection (M <sub>L</sub> ) mm	Additional links qty.	of which additional back chain links qty.
175.0	160.0	50.0	472.0	640.0	6	2
200.0	190.0	50.0	522.0	770.0	13	2
250.0	220.0	50.0	622.0	910.0	15	2
300.0	280.0	50.0	722.0	1180.0	19	2
350.0	320.0	50.0	822.0	1140.0	19	3

**MP 41.2 REARWARD RADII**

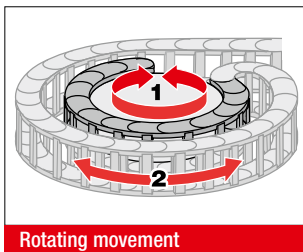

Side links with rearward radius allow movements in both directions. This is intended for rotating movements and lowered chain brackets. Rotation movements are only possible with open variants.

Type	Order No.	Radius mm	Rearward radius mm
SR 41.2 (RÜ200/R125)	041200009060	125.0	200.0
SR 41.2 (RÜ200/R160)	041200012060	160.0	200.0
SR 41.2 (RÜ200/R175)	041200015060	175.0	200.0
SR 41.2 (RÜ200/R200)	041200020060	200.0	200.0
SR 41.2 (RÜ200/R250)	041200025060	250.0	200.0
SR 41.2 (RÜ200/R300)	041200030060	300.0	200.0
SR 41.2 (RÜ200/R350)	041200035060	350.0	200.0

**GUIDE CHANNEL VAW (ALUMINIUM / STAINLESS STEEL)**



A range of variable guide channel systems, constructed from aluminium or stainless steel sections, are available for this energy chain.

The variable guide channel ensures that the energy chain is supported and guided securely.

**ASSEMBLY INSTRUCTION FLEXIBLE CHAIN BRACKET FB/FG**

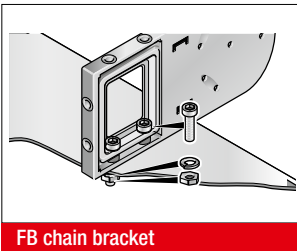

FB chain bracket

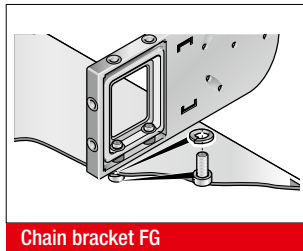

Chain bracket FG

Brass bushes guarantee long-lasting fastening without cold flow in the plastic.

**Version KA-FB:**

Integrated through-hole fastened down using screw and nut.

**Version KA-FG:**

Built-in threads allow for quick and easy on-site mounting, since a screw, including a retaining washer where necessary, is sufficient.

**ASSEMBLY**

**DISASSEMBLY**

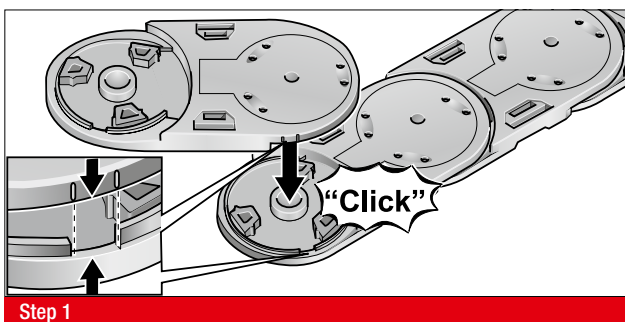

Step 1

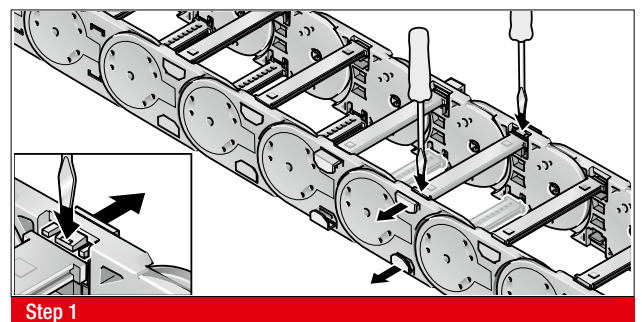

Step 1

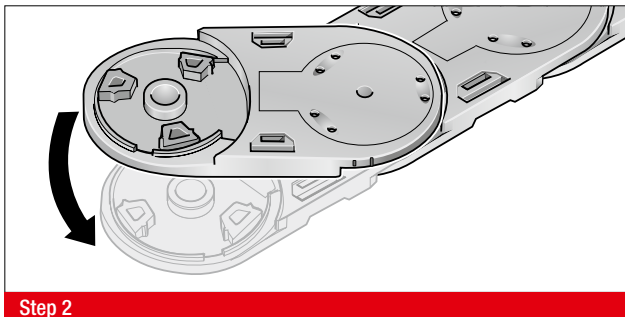

Step 2

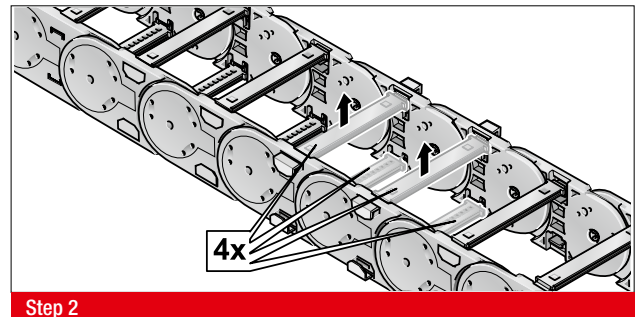

Step 2

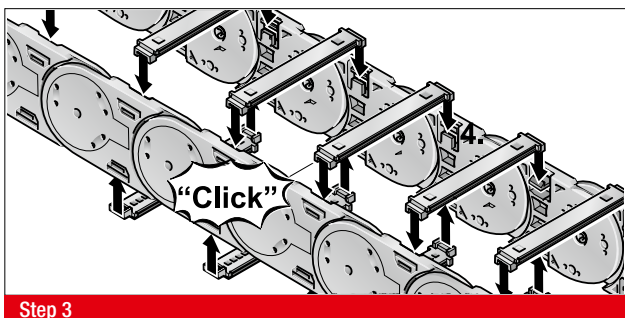

Step 3

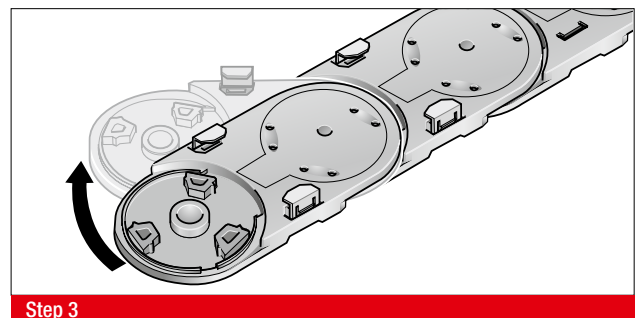

Step 3

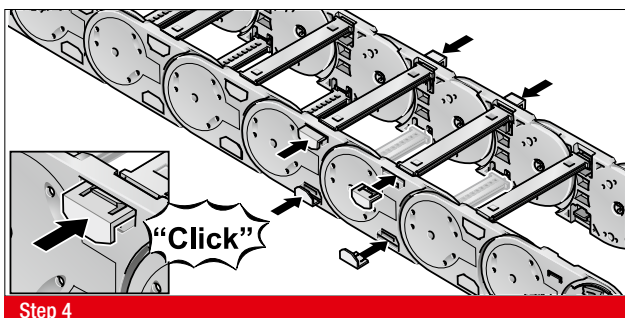

Step 4

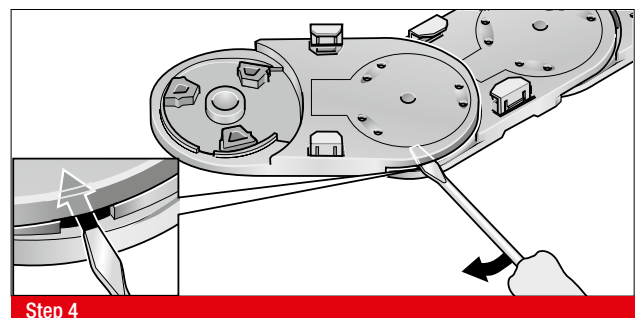

Step 4

**MP 52.2**  
OPEN



**MP 52.3**  
CLOSED



- SLIDING BLOCKS FOR LONGER SERVICE LIFE
- BROAD INTERIOR LAYOUT
- CHAIN BRACKET FLEXIBLE
- PLASTIC OR ALUMINIUM VERSION

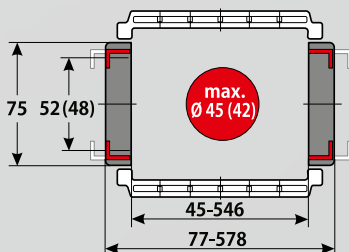

## TECHNICAL DATA

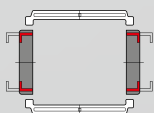

**Loading side**  
Inside and outside bend

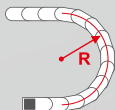

**Available radii**  
100.0 – 350.0 mm

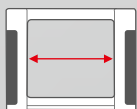

**Available interior widths**  
With plastic crossbar  
45.0 – 546.0 mm  
With alu crossbar / with alu cover  
67.0 – 600.0 mm / 43.0 – 600.0 mm

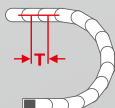

**Pitch**  
T = 91.0 mm

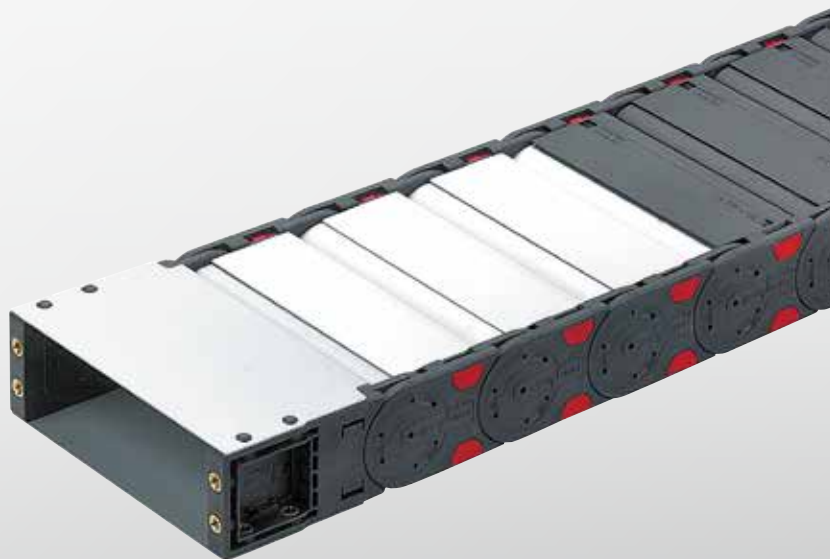

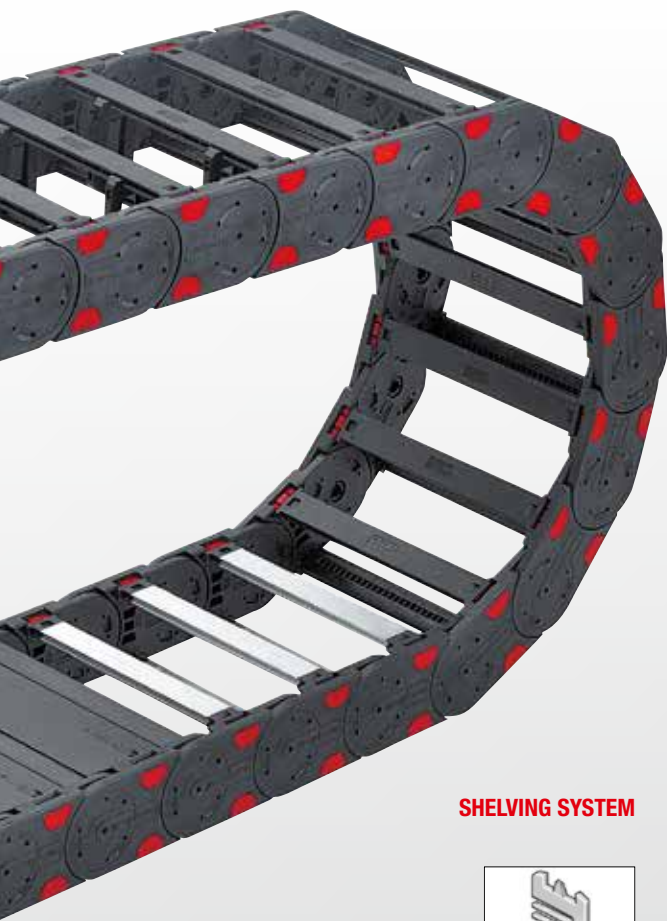

## TECHNICAL SPECIFICATIONS

Travel distance gliding $L_g$ max.	150.0 m
Travel distance self-supporting $L_s$ max.	see diagram on page 221
Travel distance vertical, hanging $L_{vh}$ max.	60.0 m
Travel distance vertical, upright $L_{vs}$ max.	6.0 m
Rotated 90°, unsupported $L_{90f}$ max.	2.0 m
Speed, gliding $V_g$ max.	5.0 m/s
Speed, self-supporting $V_s$ max.	20.0 m/s
Acceleration, gliding $a_g$ max.	25.0 m/s <sup>2</sup>
Acceleration, self-supporting $a_s$ max.	30.0 m/s <sup>2</sup>

Contact our engineering department to meet any higher requirements: [efk@murrplastik.de](mailto:efk@murrplastik.de)

## MATERIAL PROPERTIES

Standard material	Polyamide (PA) black
Service temperature	-30.0 – 120.0 °C
Gliding friction factor	0.3
Static friction factor	0.45
Fire classification	UL 94 HB

Other material properties on request.

## ACCESSORIES



Sliding block



Separator TR



Gliding plate

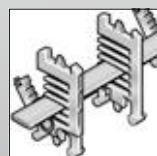

RS shelving system



Bracket bar

## CHAIN BRACKET

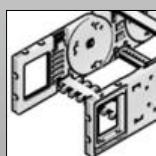

Chain bracket flexible



Crossbar connector RSV



Cover

## GUIDE CHANNELS



VAW steel galvanised / stainless steel

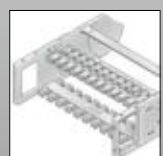

RS-ZL crossbar strain relief

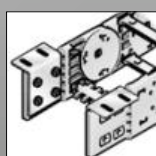

Chain bracket angle

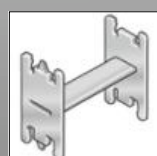

H-shaped shelf unit RE

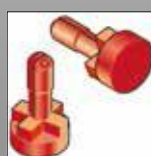

Lock button

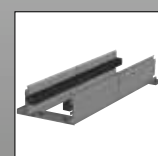

VAW aluminium

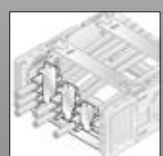

STF Steel Fix

ORDERING KEY

Dimensions in mm [US inch]

Type code	Variation	Inside width	Outside width	Inside width	Outside width	Radius	Crossbar variant	Material	Chain length
0522 30	MP 52.2 open Crossbar on outside bend Crossbar on inside bend Opens on inside and outside bend	045 <sup>1)</sup> [1.77]	077 [3.03]	233 [9.17]	265 [10.43]	100 <sup>1)</sup> [3.94]	0 Plastic, full-ridged with bias	0 Polyamide standard (PA/black)	
		057 <sup>1)</sup> [2.24]	089 [3.50]	246 <sup>2)</sup> [9.69]	278 <sup>2)</sup> [10.94]				
0523 44 <sup>3)</sup>	MP 52.3 Closed Cover on outside bend Cover on inside bend Opens on inside and outside bend	062 <sup>1)</sup> [2.44]	094 [3.70]	252 [9.92]	284 [11.18]	150 [5.91]	1 Plastic, full-ridged without bias	5 Polypropylene (PP/blue)	
		071 [2.80]	103 [4.06]	258 [10.16]	290 [11.42]				
		084 [3.31]	116 [4.57]	296 <sup>2)</sup> [11.65]	328 <sup>2)</sup> [12.91]	175 [6.89]	2 Plastic, half-ridged with bias	7 EMC (PA/light grey)	
		093 [3.66]	125 [4.92]	346 <sup>2)</sup> [13.62]	378 <sup>2)</sup> [14.88]				
		096 <sup>2)</sup> [3.78]	128 <sup>2)</sup> [5.04]	350 [13.78]	382 [15.04]	200 [7.87]	3 Plastic, half-ridged without bias	9 Special version (on request)	
		104 [4.09]	136 [5.35]	358 [14.09]	390 [15.35]				
		107 [4.21]	139 [5.47]	371 [14.61]	403 [15.87]	250 [9.84]	4 Aluminium full-ridged with bias		
		121 <sup>2)</sup> [4.76]	153 <sup>2)</sup> [6.02]	396 [15.59]	428 [16.85]				
		133 [5.24]	165 [6.50]	421 [16.57]	453 [17.83]	300 [11.81]	5 Aluminium full-ridged without bias		
		144 [5.67]	176 [6.93]	446 [17.56]	478 [18.82]				
		146 <sup>2)</sup> [5.75]	178 <sup>2)</sup> [7.01]	496 [19.53]	528 [20.79]	350 [13.78]	6 Aluminium half-ridged with bias		
		158 [6.22]	190 [7.48]	546 [21.50]	578 [22.76]				
		164 [6.46]	196 [7.72]				7 Aluminium half-ridged without bias		
		171 [6.73]	203 [7.99]						
		182 <sup>2)</sup> [7.17]	214 <sup>2)</sup> [8.43]				9 Special version (on request)		
		196 <sup>2)</sup> [7.72]	228 <sup>2)</sup> [8.98]						
		208 [8.19]	240 [9.45]						
		220 <sup>2)</sup> [8.66]	252 <sup>2)</sup> [9.92]						

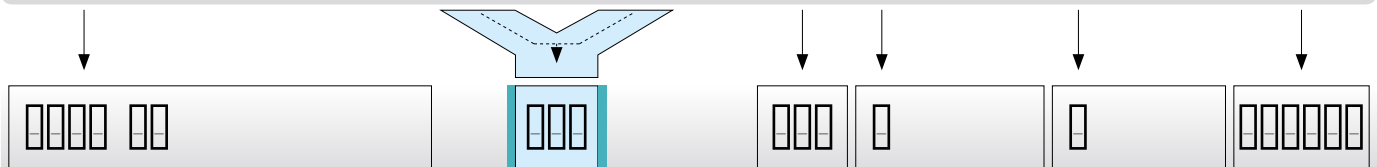

ORDERING EXAMPLE: 0522 30 220 100 0 0 1365

Crossbar on outside bend, crossbar on inside bend, can be opened from inside and outside bend  
 Inside width 220 mm, radius 100 mm  
 Plastic crossbar, full-ridged with bias, material black-coloured polyamide  
 Chain length 1365 mm (15 links)

- <sup>1)</sup> for variant 30 only
- <sup>2)</sup> also available with plastic cover
- <sup>3)</sup> reduced inner height, reduced max. cable diameter, see chain window drawing on previous page



**NOTE ON CONFIGURATION**

**Aluminium crossbars:**

Aluminium crossbars can be supplied in 1 mm width sizes for inner widths from 67.0 mm – 600.0 mm .

**Aluminium covers:**

Aluminium covers can be supplied in 1 mm width sizes for inner widths from 43.0 mm – 600.0 mm .

**Crossbar connector and crossbar strain relief plate:**

Once inside widths exceed 246 mm, we recommend the deployment of crossbar connectors (RSV).

Crossbar connectors cannot be used in conjunction with covers made from plastic or aluminium.

If crossbar strain relief plates (RS-ZL) are to be deployed in the chain brackets, take standard inside widths into account.

For detailed information, please consult the corresponding product documentation.

**SELF-SUPPORTING LENGTH**

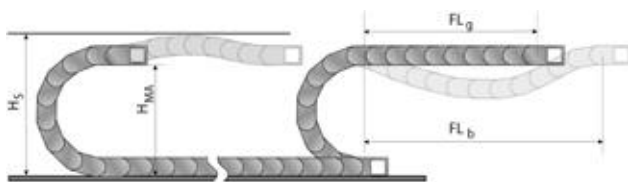

The self-supporting length is the distance between the chain bracket on the moving end and the start of the chain arch. The installation variant FL<sub>g</sub> offers the lowest load and wear for the energy chain.

The maximum travel parameters (speed and acceleration) can be applied for this variant.

- H<sub>S</sub> = Installation height plus safety
- H<sub>MA</sub> = Height of moving end connection
- FL<sub>g</sub> = Self-supporting length, upper run straight
- FL<sub>b</sub> = Self-supporting length, upper run bent

**LOAD DIAGRAM FOR SELF-SUPPORTING APPLICATIONS**

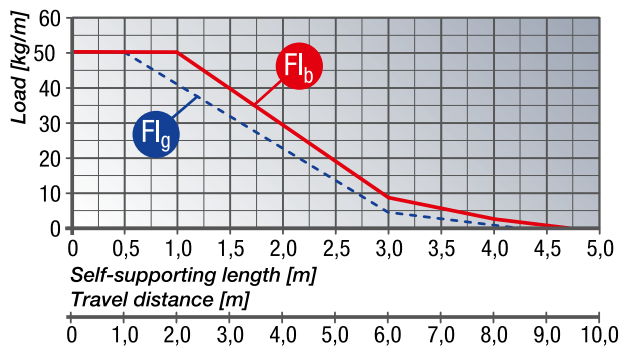

**FL<sub>g</sub> Self-supporting length, upper run straight**

In the FL<sub>g</sub> range, the chain upper run still has a bias, is straight or has a maximum sag of 70.0 mm.

**FL<sub>b</sub> Self-supporting length, upper run bent**

In the FL<sub>b</sub> range, the chain upper run has a sag of more than 70.0 mm, but this is still less than the maximum sag. Where the sag is greater than that permitted in the FL<sub>b</sub> range, the application is critical and should be avoided. The self-supporting length can be optimised by using a support for the upper run or a more stable energy chain.

Closed energy chains (with covers) have a higher unit weight than open chains (with crossbars). This higher weight must be taken into account when calculating the self-supporting length. To the weight of the cabling (cable load, in kg/m), you must add 1.5 kg/m, to account for the higher weight of closed-cover chains.

**DETERMINING THE CHAIN LENGTH**

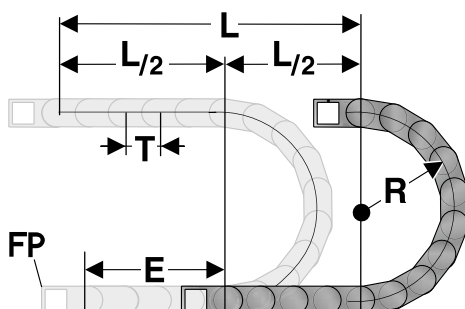

The fixed point of the energy chain should be connected in the middle of the travel distance.

This arrangement gives the shortest connection between the fixed point (FP) and the moving consumer and thus the most efficient chain length.

Chain length calculation =  $L/2 + \pi * R + E$   
 $\approx 1 \text{ m chain} = 11 \text{ qty. } \times 91.0 \text{ mm.}$

- E = Distance between entry point and middle of travel distance
- L = Travel distance
- R = Radius
- P = Pitch 91.0 mm

**INSTALLATION DIMENSIONS**

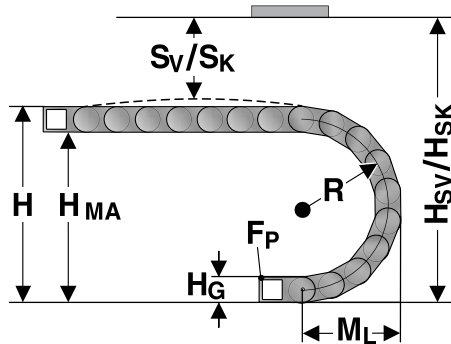

The moving end chain connection is to be screw fixed at height  $H_{MA}$  for the respective radius.  
 Concerning the installed dimensions, you must take into account whether the chain links are equipped with or without bias.  
 For chain links without bias, the “Installed height without bias  $H_{SK}$ ” value has to be taken into account.  
 If the chain links are equipped with a bias, the value “Installed height with bias  $H_{SV}$ ” has to be taken into account.

Radius R	100	150	175	200	250	300	350
Outside height of chain link ( $H_G$ )	75	75	75	75	75	75	75
Height of bend (H)	305	405	455	505	605	705	805
Height of moving end bracket ( $H_{MA}$ )	230	330	380	430	530	630	730
Safety margin with bias ( $S_V$ )	46	46	46	46	46	46	46
Installation height with bias ( $H_{SV}$ )	351	451	501	551	651	751	851
Safety margin without bias ( $S_K$ )	16	16	16	16	16	16	16
Installation height without bias ( $H_{SK}$ )	321	421	471	521	621	721	821
Arc projection ( $M_L$ )	244	294	319	344	394	444	494

**POWERLINE PLASTIC CROSSBAR**



Crossbar

The crossbars connect the two side runs of the energy chain.  
 The crossbar length is synonymous with the inside width of the energy chain.

Type	Order No.	Description	Inside width mm
RS 045-5	052004500000	Crossbar	45.0
RS 057-5	052005700000	Crossbar	57.0
RS 062-5	052006200000	Crossbar	62.0
RS 071-5	052007100000	Crossbar	71.0
RS 084-5	052008400000	Crossbar	84.0
RS 093-5	052009300000	Crossbar	93.0
RS 096-5	052009600000	Crossbar	96.0
RS 104-5	052010400000	Crossbar	104.0
RS 107-5	052010700000	Crossbar	107.0
RS 121-5	052012100000	Crossbar	121.0
RS 133-5	052013300000	Crossbar	133.0
RS 144-5	052014400000	Crossbar	144.0
RS 146-5	052014600000	Crossbar	146.0
RS 158-5	052015800000	Crossbar	158.0
RS 164-5	052016400000	Crossbar	164.0
RS 171-5	052017100000	Crossbar	171.0
RS 182-5	052018200000	Crossbar	182.0
RS 196-5	052019600000	Crossbar	196.0

**POWERLINE PLASTIC CROSSBAR**

Type	Order No.	Description	Inside width mm
RS 208-5	052020800000	Crossbar	208.0
RS 220-5	052022000000	Crossbar	220.0
RS 233-5	052023300000	Crossbar	233.0
RS 246-5	052024600000	Crossbar	246.0
RS 252-5	052025200010	Crossbar	252.0
RS 258-5	052025800000	Crossbar	258.0
RS 296-5	052029600000	Crossbar	296.0
RS 346-5	052034600000	Crossbar	346.0
RS 350-5	052035000000	Crossbar	350.0
RS 358-5	052035800000	Crossbar	358.0
RS 371-5	052037100000	Crossbar	371.0
RS 396-5	052039600000	Crossbar	396.0
RS 421-5	052042100000	Crossbar	421.0
RS 446-5	052044600000	Crossbar	446.0
RS 496-5	052049600000	Crossbar	496.0
RS 546-5	052054600000	Crossbar	546.0

**MP 52.3 / MP 52.5 PLASTIC COVER**



Cover

The covers connect the two side runs of the energy chain. The cover length is synonymous with the inside width of the energy chain.

Type	Order No.	Description	Installation site	Inside width mm
A-523062, outside	052306210000	Cover	Outside bend	62.0
I-523062, inside	052306220000	Cover	Inside bend	62.0
A-523096, outside	052309610000	Cover	Outside bend	96.0
I-523096, inside	052309620000	Cover	Inside bend	96.0
A-523121, outside	052312110000	Cover	Outside bend	121.0
I-523121, inside	052312120000	Cover	Inside bend	121.0
A-523146, outside	052314610000	Cover	Outside bend	146.0
I-523146, inside	052314620000	Cover	Inside bend	146.0
A-523182, outside	052318210000	Cover	Outside bend	182.0
I-523182, inside	052318220000	Cover	Inside bend	182.0
A-523196, outside	052319610000	Cover	Outside bend	196.0
I-523196, inside	052319620000	Cover	Inside bend	196.0
A-523220, outside	052322010000	Cover	Outside bend	220.0
I-523220, inside	052322020000	Cover	Inside bend	220.0
A-523246, outside	052324610000	Cover	Outside bend	246.0
I-523246, inside	052324620000	Cover	Inside bend	246.0
A-523296, outside	052329610000	Cover	Outside bend	296.0
I-523296, inside	052329620000	Cover	Inside bend	296.0
A-523346, outside	052334610000	Cover	Outside bend	346.0
I-523346, inside	052334620000	Cover	Inside bend	346.0

**KA 52.1 CHAIN BRACKET FLEXIBLE**

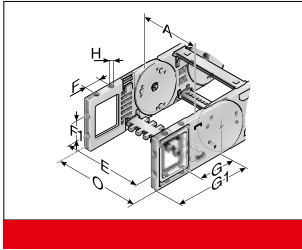

This chain bracket offers universal connection options (top, bottom and front) and is attached to the ends of the chain like a side link. This allows the chain to move right up to the bracket. Each chain requires one male and one female bracket. M8 screws are used to secure the brackets in place. Extrusion-coated metal bushes with either a through-hole (-FB) or a threaded hole (-FG) ensure the permanent, high-strength transmission of even extreme forces onto the energy chain.

Type	Order No.	Material	Version	Inside width								Outside width of KA 0 mm
				A mm	E mm	F mm	F1 mm	G mm	G1 mm	H mm	HØ mm	
KA 52.1-FB Female end	0521000056	Plastic	with bush	45.0 – 546.0	A+16.0	35.0	30.0	89.0	146.0	146.0	8.5	A+36.0
KA 52.1-FB Male end	0521000057	Plastic	with bush	45.0 – 546.0	A+16.0	35.0	30.0	89.0	146.0	146.0	8.5	A+36.0
KA 52.1-FG Female end	0521000058	Plastic	with thread	45.0 – 546.0	A+16.0	35.0	30.0	89.0	146.0	146.0	M8	A+36.0
KA 52.1-FG Male end	0521000059	Plastic	with thread	45.0 – 546.0	A+16.0	35.0	30.0	89.0	146.0	146.0	M8	A+36.0

**KA 52.1 CHAIN BRACKET ANGLE**

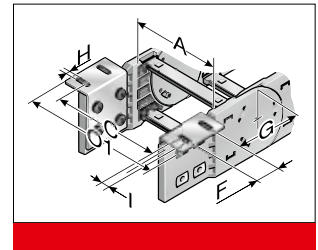
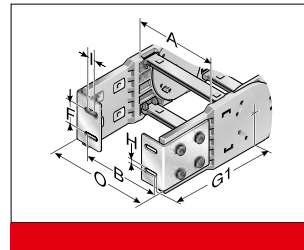
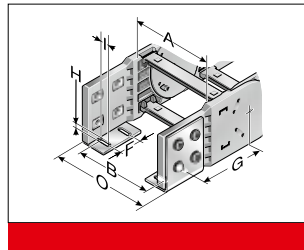
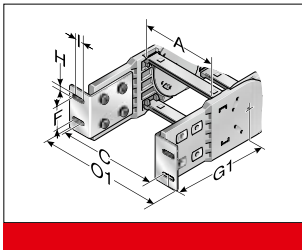

There are several options regarding the chain bracket. The fixed-point bracket (inside/bottom) and the moving end bracket (inside/top) are supplied as standard. However, any other combination can be supplied upon request. The chain bracket is

fastened at the end like a side link. This enables the chain to move right up to the bracket. Each chain requires one male and one female bracket. The brackets should be fastened with M6 screws.

Type	Order No.	Material	Inside width								Outside width of KA 0 mm	Outside width of KA 01 mm
			A mm	B mm	C mm	F mm	G mm	G1 mm	HØ mm	I mm		
KA 52.1 Female end	0521000050	Sheet steel	45.0 – 546.0	A-2.5	A+34.5	32.0	95.5	144.0	6.5	14.0	A+32.0	A+71.0
KA 52.1 Male end	0521000051	Sheet steel	45.0 – 546.0	A-2.5	A+34.5	32.0	95.5	144.0	6.5	14.0	A+32.0	A+71.0

**GS 52.2 SLIDING BLOCK**

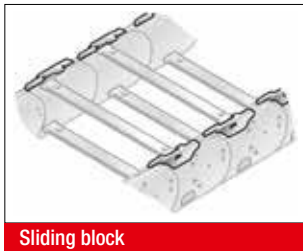

Sliding block

In the case of energy chains, sliding blocks are used in a horizontally sliding installation mode (the tight side of the chain slides on the slack side). The sliding blocks are set onto the side links on the interior bend instead of the usual crossbar interlocks; (no tools needed). This forces the chain to slide on the sliding blocks instead on the side links of the chain. Depending on the application, the service life of the energy chain may be extended five-fold, by using slide blocks. Information about the minimum bending radius of the energy chain at the sliding block insert is listed in the following table.

Type	Order No.	Installation site	Min. radius mm	Sliding block height mm
GS 52.2.1 right	052290400302	For right side link	150.0	4.0
GS 52.2.2 left	052290400300	For left side link	150.0	4.0

**GLP 5 (52.2) GLIDING PLATE**

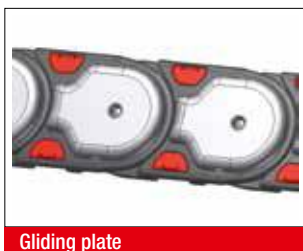

Gliding plate

The gliding plates are mounted in a horizontal position, with the chain laying on its side, to minimize friction wear to the sides. They are mounted to the side links using a special screw. The wear limit is 2.5 mm. We recommend replacing the energy chain when this limit has been reached. Depending on the application, the service life of the energy chain may be extended two-fold, by using gliding plates. The energy chain must be placed on its side before opening.

Type	Order No.	Installation site	For radius mm	Gliding plate height mm
SG 52.2 RK100.1 right with GLP5, mounted	052200010066	Right chain link including gliding plate	100.0	7.0
SG 52.2 RK100.2 left with GLP5, mounted	052200010064	Left chain link including gliding plate	100.0	7.0
SG 52.2 RK150.1 right with GLP5, mounted	052200015066	Right chain link including gliding plate	150.0	7.0
SG 52.2 RK150.2 left with GLP5, mounted	052200015064	Left chain link including gliding plate	150.0	7.0
SG 52.2 RK175.1 right with GLP5, mounted	052200017566	Right chain link including gliding plate	175.0	7.0
SG 52.2 RK175.2 left with GLP5, mounted	052200017564	Left chain link including gliding plate	175.0	7.0
SG 52.2 RK200.1 right with GLP5, mounted	052200020066	Right chain link including gliding plate	200.0	7.0
SG 52.2 RK200.2 left with GLP5, mounted	052200020064	Left chain link including gliding plate	200.0	7.0
SG 52.2 RK250.1 right with GLP5, mounted	052200025066	Right chain link including gliding plate	250.0	7.0
SG 52.2 RK250.2 left with GLP5, mounted	052200025064	Left chain link including gliding plate	250.0	7.0
SG 52.2 RK300.1 right with GLP5, mounted	052200030066	Right chain link including gliding plate	300.0	7.0
SG 52.2 RK300.2 left with GLP5, mounted	052200030064	Left chain link including gliding plate	300.0	7.0
SG 52.2 RK350.1 right with GLP5, mounted	052200035066	Right chain link including gliding plate	350.0	7.0
SG 52.2 RK350.2 left with GLP5, mounted	052200035064	Left chain link including gliding plate	350.0	7.0

**TR 52 SEPARATOR**

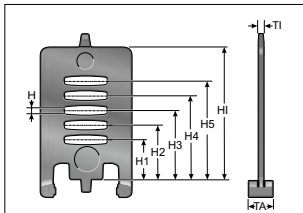

Separator

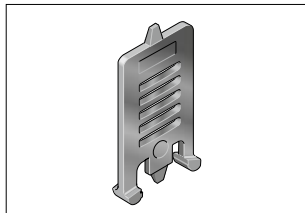

Separator

We recommend that separators be used if multiple round cables or conduits with differing diameters are to be installed. The closed separator is used when no shelves are used. This is the recommended design for travel paths of 30 metres or greater.

Type	Order No.	Description	Version	TI mm	TA mm	H mm	H1 mm	H2 mm	H3 mm	H4 mm	H5 mm	H1 mm
TR 52	052000009200	TR 52 Separator	lockable	3.5	10.0	4.2	16.3	22.3	28.2	33.8	39.8	52.0

**TR 52.1 SEPARATOR**

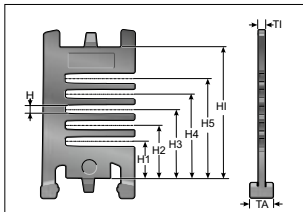

Separator

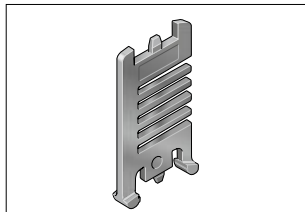

Separator

We recommend that separators be used if multiple round cables or conduits with differing diameters are to be installed.

Type	Order No.	Description	Version	TI mm	TA mm	H mm	H1 mm	H2 mm	H3 mm	H4 mm	H5 mm	H1 mm
TR 52.1	052100009200	TR 52.1 Separator	lockable	3.5	8.0	4.0	15.6	22.0	28.2	34.6	41.0	52.0

**TR 52-V SEPARATOR**

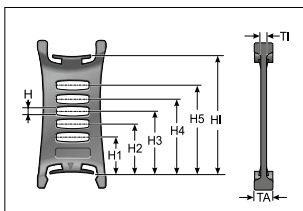

Separator

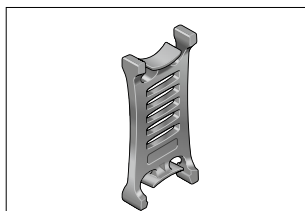

Separator

We recommend that separators be used if multiple round cables or conduits with differing diameters are to be installed.

Type	Order No.	Description	Version	TI mm	TA mm	H mm	H1 mm	H2 mm	H3 mm	H4 mm	H5 mm	H1 mm
TR 52-V	052000009300	TR 52-V Separator	moveable	3.5	13.0	4.0	16.3	22.3	28.2	33.8	39.8	52.0

**RTT 52 SHELF SUPPORT, DIVISIBLE**

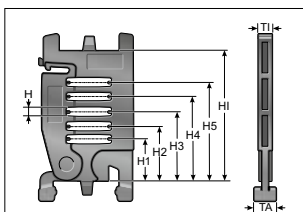

Shelf support

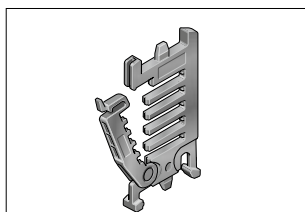

Shelf support

In connection with two separable shelf supports (RTT) with at least one end-to-end shelf (RB) the shelf becomes an easy to fill shelving system. The additional levels prevent cables from criss-crossing and minimise the friction between them.

Type	Order No.	Description	Version	TI mm	TA mm	H mm	H1 mm	H2 mm	H3 mm	H4 mm	H5 mm	H1 mm
RTT 52	100090522000	Shelf support, divisible	lockable	7.0	8.0	4.0	15.6	22.0	28.2	34.6	41.0	52.0

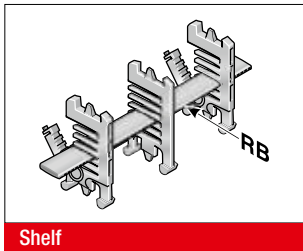
**RB-5 SHELF**

In connection with at least two separable shelf supports (RTT), the shelf becomes a shelving system. The additional levels prevent cables from criss-crossing and minimise the friction between them.

Type	Order No.	Description	Width mm	Inside width mm
RB 028-5	10000002800	Shelf	28.0	45.0
RB 034-5	1000003405	Shelf	33.6	45.0
RB 039-5	1000003905	Shelf	39.2	45.0
RB 045-5	1000004505	Shelf	44.8	57.0
RB 050-5	1000005005	Shelf	50.4	57.0
RB 056-5	10000005601	Shelf	56.0	62.0
RB 062-5	1000006205	Shelf	61.6	62.0
RB 067-5	1000006705	Shelf	67.2	84.0
RB 073-5	1000007305	Shelf	72.8	84.0
RB 078-5	1000007805	Shelf	78.4	84.0
RB 084-5	10000008400	Shelf	84.0	84.0
RB 090-5	1000009005	Shelf	89.6	96.0
RB 095-5	1000009505	Shelf	95.2	96.0
RB 101-5	1000010105	Shelf	100.8	107.0
RB 106-5	1000010605	Shelf	106.4	107.0
RB 112-5	100000011200	Shelf	112.0	121.0
RB 118-5	1000011805	Shelf	117.6	121.0
RB 123-5	1000012305	Shelf	123.2	133.0
RB 129-5	1000012905	Shelf	128.8	133.0
RB 134-5	1000013405	Shelf	134.4	144.0
RB 140-5	100000014000	Shelf	140.0	144.0
RB 146-5	1000014605	Shelf	145.6	158.0
RB 151-5	1000015105	Shelf	151.2	158.0
RB 157-5	1000015705	Shelf	156.8	164.0
RB 162-5	1000016205	Shelf	162.4	164.0
RB 168-5	100000016800	Shelf	168.0	182.0
RB 174-5	1000017405	Shelf	173.6	182.0
RB 179-5	1000017905	Shelf	179.2	196.0
RB 185-5	1000018505	Shelf	184.8	196.0
RB 190-5	1000019005	Shelf	190.4	196.0
RB 196-5	100000019600	Shelf	196.0	196.0
RB 291-5	100000029100	Shelf	291.2	346.0

### RSV 52 CROSSBAR CONNECTOR



For crossbars wider than 246 mm, we recommend the use of crossbar connectors. These prevent deformation to the crossbar under large amounts of additional weight of the chain assembly.

Type	Order No.	Description	TI mm
RSV 52	052000009600	Crossbar connector	7.5
RSV 52 Alu	052000009800	Crossbar connector for aluminium crossbars	7.5

### RE 52 H-SHAPED SHELF UNIT

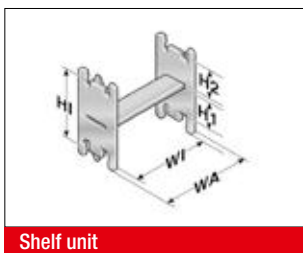

One-piece shelving system, the shelf cannot be varied in height.

Type	Order No.	Description	WA mm	WI mm	H1 mm	H2 mm	HI mm
RE 36/17	100000361714	H-shaped shelf unit	42.5	36.5	31.0	17.4	52.0
RE 59/24	100000592414	H-shaped shelf unit	65.0	59.0	24.2	24.2	52.0
RE 81/12	100000811214	H-shaped shelf unit	87.5	81.5	36.0	12.4	52.0

### BS-5 BRACKET BAR



Large-diameter conduits are routed securely by using a bracket bar (BS). This bar is installed on the crossbars or the covers of the energy chain.

The bracket bar can be installed on both the inside and outside bend.

The bracket bar support (BSH) is used to attach the bars to PowerLine series crossbars. Two bracket bar supports are required for each bar.

Type	Order No.	Description	Conduit diameter max. mm	Installation height mm	Inner chain width min. mm
BS 120-5	052412000000	Bracket bar	115.0	140.0	164.0
BS 153-5	052415300000	Bracket bar	148.0	170.0	208.0
BS 187-5	052418700000	Bracket bar	182.0	205.0	233.0
BSH-5	052400000000	Bracket bar support			
Assembly set	052400000001	Assembly set			



**D5 CHAIN BRACKET COVER**

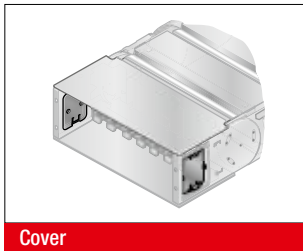

Self-locking covers close the side mounting window on the flexible chain bracket (KA-FB/FG).

Type	Order No.
D5 Cover	0523888002

**MP 52.3 CHAIN BRACKET CANOPY**

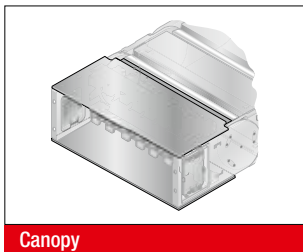

Constructed from aluminium, the canopies for the flexible chain bracket (KA-FB/FG) ensure a continuously closed system for chains with covers.

**Canopy for chain bracket fixed point outside bend: Type and order number configurator**



Type:	KA 52.1 FB/FG AB	Inside width	2-2
Order No.:	0521	Inside width	060

**Canopy for chain bracket fixed point inside bend: Type and order number configurator**

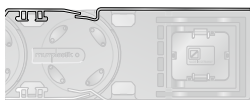

Type:	KA 52.1 FB/FG IB	Inside width	2-2
Order No.:	0521	Inside width	058

**Canopy for chain bracket moving end outside bend: Type and order number configurator**



Type:	KA 52.1 FB/FG AB	Inside width	1-2
Order No.:	0521	Inside width	059

**Canopy for chain bracket moving end inside bend: Type and order number configurator**



Type:	KA 52.1 FB/FG IB	Inside width	1-2
Order No.:	0521	Inside width	057

**Ordering example:**

0521096058 KA 52.1 FB/FG IB 096 2-2

Chain bracket canopy at fixing point in inside bend, for inside width of 96 mm.

**RS-ZL-5 CROSSBAR STRAIN RELIEF PLATE**

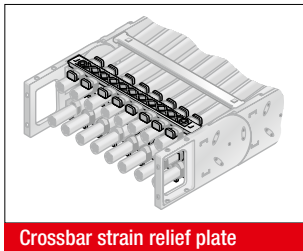

Fixed integrated frame bridge strain relief plates in the chain brackets. Tailored to all crossbar widths up to 246 mm. May be assembled on the inside and outside bends at both chain endings.

Type	Order No.	Description	Inside width mm
RS-ZL 045-5	052004500010	Crossbar strain relief plate	45.0
RS-ZL 057-5	052005700010	Crossbar strain relief plate	57.0
RS-ZL 062-5	052006200010	Crossbar strain relief plate	62.0
RS-ZL 071-5	052007100010	Crossbar strain relief plate	71.0
RS-ZL 084-5	052008400010	Crossbar strain relief plate	84.0
RS-ZL 093-5	052009300010	Crossbar strain relief plate	93.0
RS-ZL 096-5	052009600010	Crossbar strain relief plate	96.0
RS-ZL 104-5	052010400010	Crossbar strain relief plate	104.0
RS-ZL 107-5	052010700010	Crossbar strain relief plate	107.0
RS-ZL 121-5	052012100010	Crossbar strain relief plate	121.0
RS-ZL 133-5	052013300010	Crossbar strain relief plate	133.0
RS-ZL 144-5	052014400010	Crossbar strain relief plate	144.0
RS-ZL 146-5	052014600010	Crossbar strain relief plate	146.0
RS-ZL 158-5	052015800010	Crossbar strain relief plate	158.0
RS-ZL 164-5	052016400010	Crossbar strain relief plate	164.0
RS-ZL 171-5	052017100010	Crossbar strain relief plate	171.0
RS-ZL 182-5	052018200010	Crossbar strain relief plate	182.0
RS-ZL 196-5	052019600010	Crossbar strain relief plate	196.0
RS-ZL 208-5	052020800010	Crossbar strain relief plate	208.0
RS-ZL 220-5	052022000010	Crossbar strain relief plate	220.0
RS-ZL 233-5	052023300010	Crossbar strain relief plate	233.0
RS-ZL 246-5	052024600010	Crossbar strain relief plate	246.0

**MP 52/62/72 LOCK BUTTON**

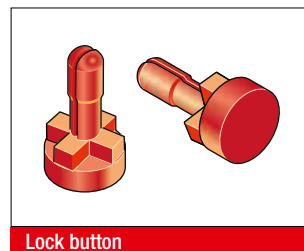
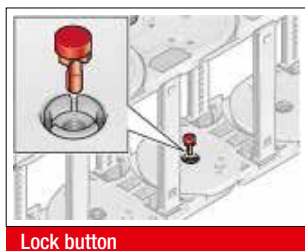
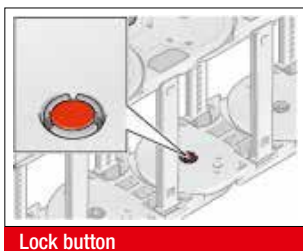

To increase the side stability, we recommend the use of lock buttons during strong lateral acceleration or when installed

“laying on the side (turned 90°) without support”.

Type	Order No.
MP52/62/72 lock button	0520000080

**STRAIN RELIEF WITH STEEL FIX**

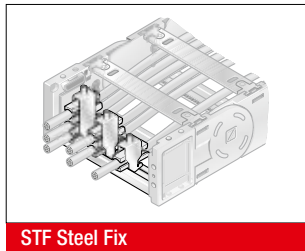
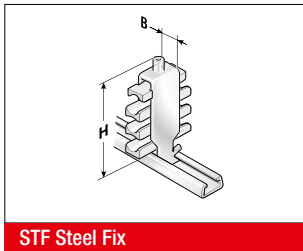

C-rails (galvanised) for permanent integration, for accommodating the Steel Fix bow clamps in the chain brackets. The bow clamps can take up to 3 cables and are suitable for C-rails with a groove width of 11 mm. Due to the design of the trough elements, a cable preserving cable guidance is ensured. May be assembled on the inside and outside bends at both chain endings. The overall height stated is a guide only. The actual height is, amongst other things, dependent on the diameter and the quality of the cable. A safety distance of 10 mm at the fixed point above the strain relief must be kept during gliding applications.

Type	Order No.	Description	Seats qty.	Cable Ø mm	Width mm	Total height (H) mm
<b>Single clamp (for one cable)</b>						
STF 12-1 Steel Fix	81661801	Hooped clamp	1	6.0 – 12.0	16.0	55.0
STF 14-1 Steel Fix	81661802	Hooped clamp	1	12.0 – 14.0	18.0	52.0
STF 16-1 Steel Fix	81661803	Hooped clamp	1	14.0 – 16.0	20.0	54.0
STF 18-1 Steel Fix	81661804	Hooped clamp	1	16.0 – 18.0	22.0	56.0
STF 20-1 Steel Fix	81661805	Hooped clamp	1	18.0 – 20.0	24.0	59.0
STF 22-1 Steel Fix	81661806	Hooped clamp	1	20.0 – 22.0	26.0	61.0
STF 26-1 Steel Fix	81661807	Hooped clamp	1	22.0 – 26.0	30.0	70.0
STF 30-1 Steel Fix	81661808	Hooped clamp	1	26.0 – 30.0	34.0	74.0
STF 34-1 Steel Fix	81661809	Hooped clamp	1	30.0 – 34.0	38.0	78.0
STF 38-1 Steel Fix	81661810	Hooped clamp	1	34.0 – 38.0	42.0	82.0
STF 42-1 Steel Fix	81661811	Hooped clamp	1	38.0 – 42.0	46.0	91.0
<b>Double clamp (for two cables)</b>						
STF 12-2 Steel Fix	81661821	Hooped clamp	2	6.0 – 12.0	16.0	73.0
STF 14-2 Steel Fix	81661822	Hooped clamp	2	12.0 – 14.0	18.0	74.0
STF 16-2 Steel Fix	81661823	Hooped clamp	2	14.0 – 16.0	20.0	82.0
STF 18-2 Steel Fix	81661824	Hooped clamp	2	16.0 – 18.0	22.0	86.0
STF 20-2 Steel Fix	81661825	Hooped clamp	2	18.0 – 20.0	24.0	91.0
STF 22-2 Steel Fix	81661826	Hooped clamp	2	20.0 – 22.0	26.0	95.0
STF 26-2 Steel Fix	81661827	Hooped clamp	2	22.0 – 26.0	30.0	108.0
STF 30-2 Steel Fix	81661828	Hooped clamp	2	26.0 – 30.0	34.0	121.0
STF 34-2 Steel Fix	81661829	Hooped clamp	2	30.0 – 34.0	38.0	129.0
<b>Triple clamp (for three cables)</b>						
STF 12-3 Steel Fix	81661841	Hooped clamp	3	6.0 – 12.0	16.0	98.0
STF 14-3 Steel Fix	81661842	Hooped clamp	3	12.0 – 14.0	18.0	98.0
STF 16-3 Steel Fix	81661843	Hooped clamp	3	14.0 – 16.0	20.0	105.0
STF 18-3 Steel Fix	81661844	Hooped clamp	3	16.0 – 18.0	22.0	111.0
STF 20-3 Steel Fix	81661845	Hooped clamp	3	18.0 – 20.0	24.0	118.0
STF 22-3 Steel Fix	81661846	Hooped clamp	3	20.0 – 22.0	26.0	130.0

**LOWERED FIXING POINT MP 52**

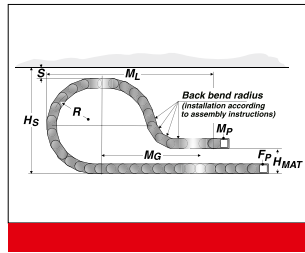
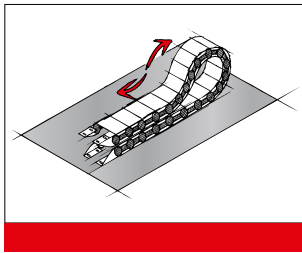

It is sometimes necessary to lower the height of the moving attachment point.

In such cases, modifications to the chain layout should be noted (e.g. extension of chain).

Please contact our application engineers.

Radius R mm	Height of moving end bracket (H <sub>MA</sub> ) mm	Safety margin (S) mm	Installation height incl. safety (H <sub>s</sub> ) mm	Projection (M <sub>1</sub> ) mm	Additional links qty.	of which additional back chain links qty.
175.0	180.0	50.0	515.0	620.0	6	3
200.0	210.0	50.0	565.0	830.0	10	3
250.0	250.0	50.0	665.0	990.0	13	3
300.0	300.0	50.0	765.0	900.0	14	3
350.0	330.0	50.0	865.0	1180.0	16	3

**MP 52.2 REARWARD RADII**

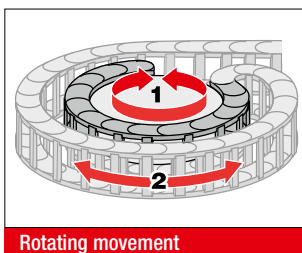

Side links with rearward radius allow movements in both directions. This is intended for rotating movements and lowered chain brackets. Note: This type of chain has different chain links for the left or right side! Rotation movements are only possible with open variants.

Type	Order No.	Radius mm	Rearward radius mm
SR 52.2 (RÜ200/R135) left	052200010060	135.0	200.0
SR 52.2 (RÜ200/R135) right	052200010062	135.0	200.0
SR 52.2 (RÜ200/R170) left	052200015060	170.0	200.0
SR 52.2 (RÜ200/R170) right	052200015062	170.0	200.0
SR 52.2 (RÜ200/R200) left	052200020060	200.0	200.0
SR 52.2 (RÜ200/R200) right	052200020062	200.0	200.0
SR 52.2 (RÜ200/R250) left	052200025060	250.0	200.0
SR 52.2 (RÜ200/R250) right	052200025062	250.0	200.0
SR 52.2 (RÜ200/R300) right	052200030062	300.0	200.0
SR 52.2 (RÜ200/R350) left	052200035060	350.0	200.0
SR 52.2 (RÜ200/R350) right	052200035062	350.0	200.0

**GUIDE CHANNEL VAW (ALUMINIUM / STAINLESS STEEL)**



VAW steel galvanised / stainless steel



VAW aluminium

A range of variable guide channel systems, constructed from aluminium or stainless steel sections, are available for this energy chain.

The variable guide channel ensures that the energy chain is supported and guided securely.

**ASSEMBLY INSTRUCTION FLEXIBLE CHAIN BRACKET FB/FG**

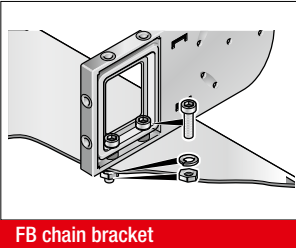

FB chain bracket

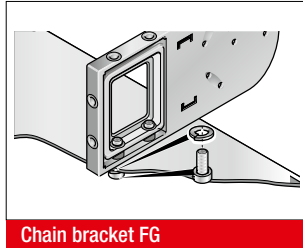

Chain bracket FG

Brass bushes guarantee long-lasting fastening without cold flow in the plastic.

**Version KA-FB:**

Integrated through-hole fastened down using screw and nut.

**Version KA-FG:**

Built-in threads allow for quick and easy on-site mounting, since a screw, including a retaining washer where necessary, is sufficient.

**ASSEMBLY**

**DISASSEMBLY**

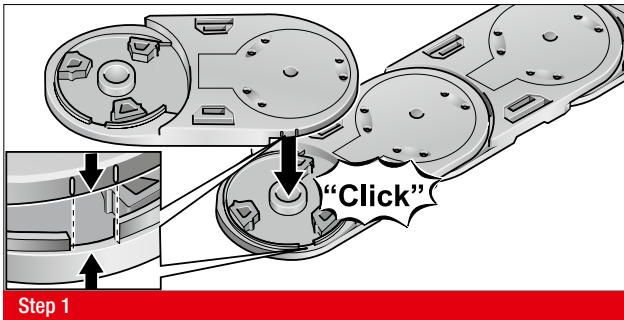

Step 1

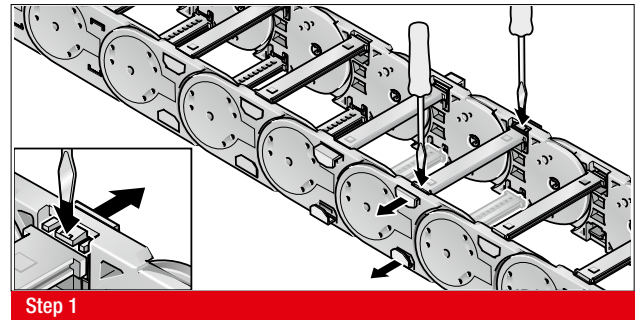

Step 1

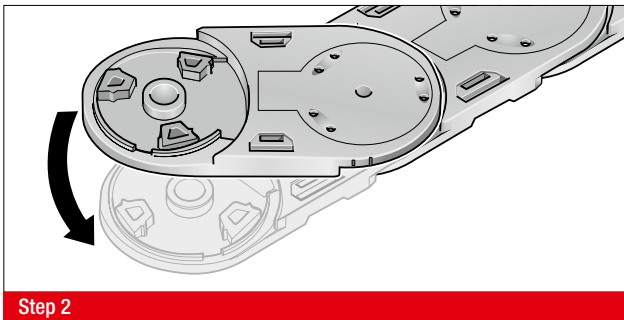

Step 2

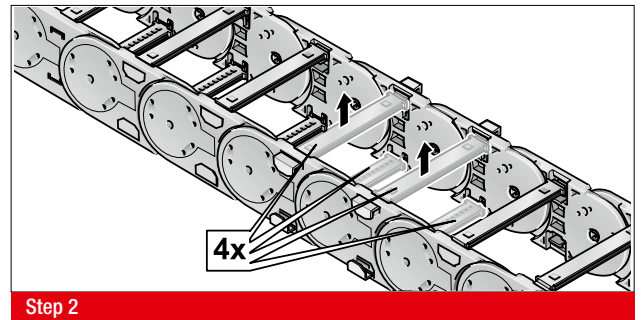

Step 2

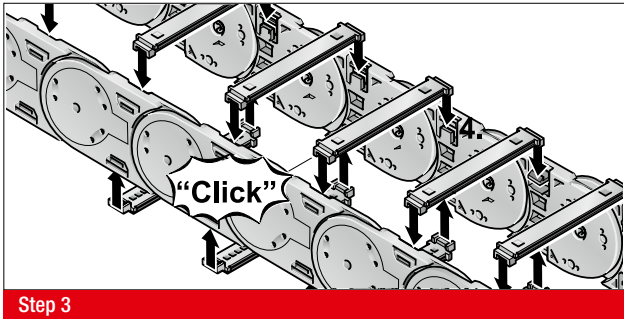

Step 3

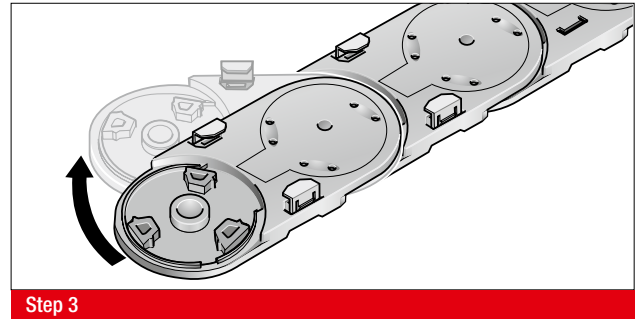

Step 3

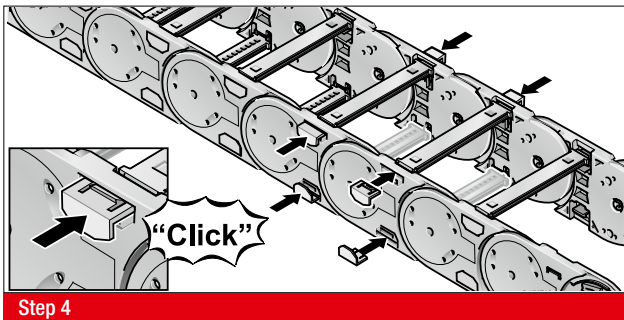

Step 4

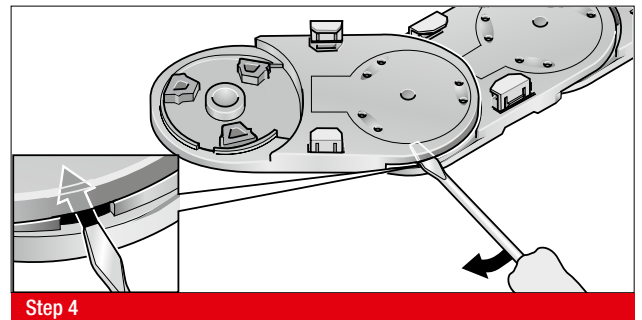

Step 4

## MP 52.2-D OPEN



## MP 52.3-D CLOSED

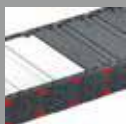

- SOFT-STOP SYSTEM
- SLIDING BLOCKS FOR LONGER SERVICE LIFE
- BROAD INTERIOR LAYOUT
- CHAIN BRACKET FLEXIBLE
- PLASTIC OR ALUMINIUM VERSION

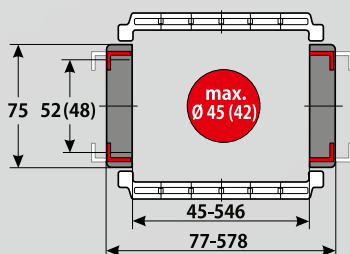

### TECHNICAL DATA

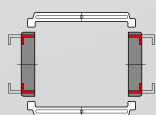

**Loading side**  
Inside and outside bend

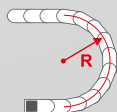

**Available radii**  
200.0

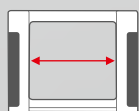

**Available interior widths**  
With plastic crossbar  
45.0 – 546.0  
With alu crossbar / with alu cover  
67.0 – 600.0 mm / 43.0 – 600.0 mm

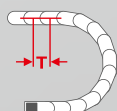

**Pitch**  
T = 91.0 mm



**Noise attenuator**  
Reduction of the noise emission by up to 10 dB(A) by the use of damping elements in the chain links.

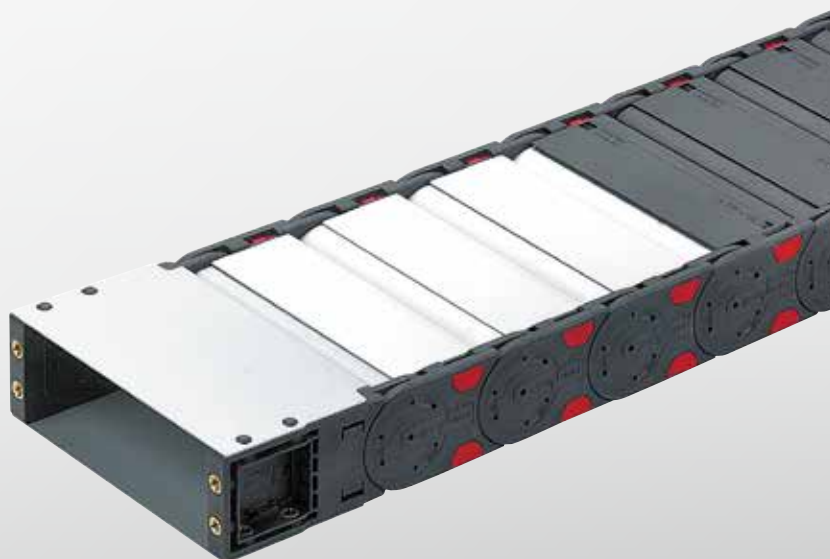

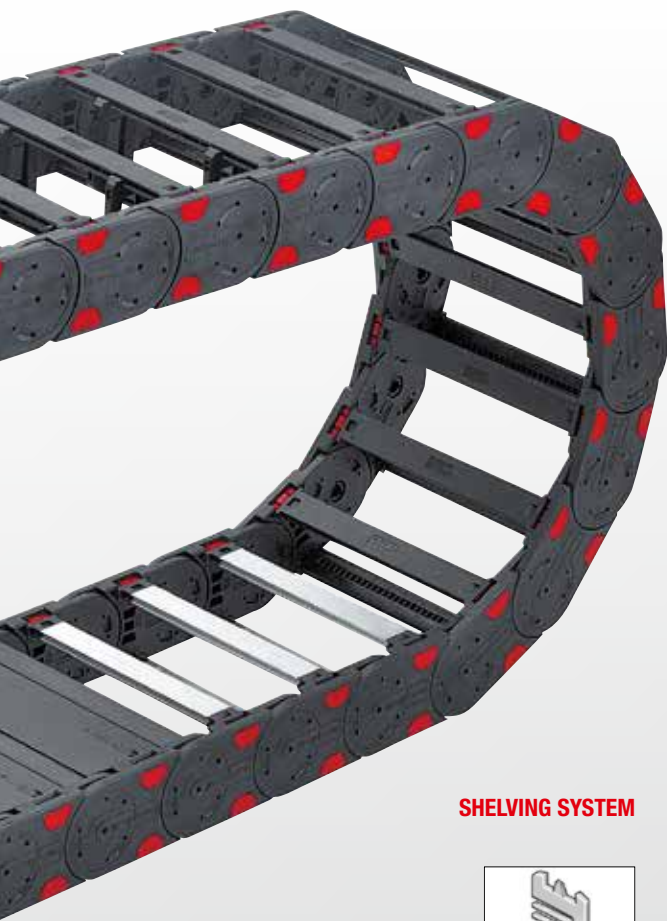

## TECHNICAL SPECIFICATIONS

Travel distance gliding $L_g$ max.	150.0 m
Travel distance self-supporting $L_s$ max.	see diagram on page 237
Travel distance vertical, hanging $L_{vh}$ max.	60.0 m
Travel distance vertical, upright $L_{vs}$ max.	6.0 m
Rotated 90°, unsupported $L_{90f}$ max.	2.0 m
Speed, gliding $V_g$ max.	5.0 m/s
Speed, self-supporting $V_f$ max.	20.0 m/s
Acceleration, gliding $a_g$ max.	25.0 m/s <sup>2</sup>
Acceleration, self-supporting $a_s$ max.	30.0 m/s <sup>2</sup>

Contact our engineering department to meet any higher requirements: [efk@murrplastik.de](mailto:efk@murrplastik.de)

## MATERIAL PROPERTIES

Standard material	Polyamide (PA) black
Service temperature	-30.0 – 120.0 °C
Gliding friction factor	0.3
Static friction factor	0.45
Fire classification	UL 94 HB

Other material properties on request.

## ACCESSORIES



Sliding block



Separator TR

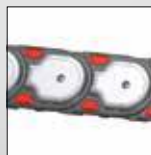

Gliding plate

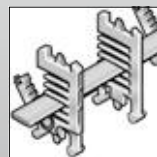

RS shelving system



Bracket bar

## CHAIN BRACKET

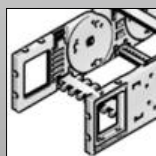

Chain bracket flexible



Crossbar connector RSV



Cover

## GUIDE CHANNELS



VAW steel galvanised / stainless steel



RS-ZL crossbar strain relief

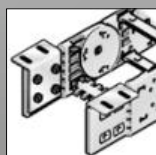

Chain bracket angle



H-shaped shelf unit RE

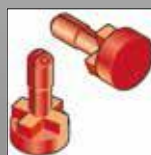

Lock button

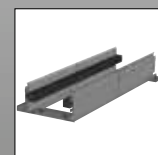

VAW aluminium

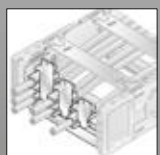

STF Steel Fix

## STRAIN RELIEF

**ORDERING KEY**

Dimensions in mm [US inch]

Type code	Variation	Inside width	Outside width	Inside width	Outside width	Radius	Crossbar variant	Material	Chain length
<b>0522 30</b>	MP 52.2-D open Crossbar on outside bend Crossbar on inside bend Opens on inside and outside bend	<b>045<sup>1)</sup></b> [1.77]	<b>077</b> [3.03]	<b>233</b> [9.17]	<b>265</b> [10.43]	<b>200</b> [7.87]	<b>0</b> Plastic, full-ridged with bias	<b>3</b> Polyamide with attenuator (PA/black)	
		<b>057<sup>1)</sup></b> [2.24]	<b>089</b> [3.50]	<b>246<sup>2)</sup></b> [9.69]	<b>278<sup>2)</sup></b> [10.94]				
<b>0523 44<sup>3)</sup></b>	MP 52.3-D Closed Cover on outside bend Cover on inside bend Opens on inside and outside bend	<b>062<sup>1)</sup></b> [2.44]	<b>094</b> [3.70]	<b>252</b> [9.92]	<b>284</b> [11.18]		<b>1</b> Plastic, full-ridged without bias	<b>9</b> Special version (on request)	
		<b>071</b> [2.80]	<b>103</b> [4.06]	<b>258</b> [10.16]	<b>290</b> [11.42]				
		<b>084</b> [3.31]	<b>116</b> [4.57]	<b>296<sup>2)</sup></b> [11.65]	<b>328<sup>2)</sup></b> [12.91]		<b>2</b> Plastic, half-ridged with bias		
		<b>093</b> [3.66]	<b>125</b> [4.92]	<b>346<sup>2)</sup></b> [13.62]	<b>378<sup>2)</sup></b> [14.88]				
		<b>096<sup>2)</sup></b> [3.78]	<b>128<sup>2)</sup></b> [5.04]	<b>350</b> [13.78]	<b>382</b> [15.04]		<b>3</b> Plastic, half-ridged without bias		
		<b>104</b> [4.09]	<b>136</b> [5.35]	<b>358</b> [14.09]	<b>390</b> [15.35]				
		<b>107</b> [4.21]	<b>139</b> [5.47]	<b>371</b> [14.61]	<b>403</b> [15.87]		<b>4</b> Aluminium full-ridged with bias		
		<b>121<sup>2)</sup></b> [4.76]	<b>153<sup>2)</sup></b> [6.02]	<b>396</b> [15.59]	<b>428</b> [16.85]				
		<b>133</b> [5.24]	<b>165</b> [6.50]	<b>421</b> [16.57]	<b>453</b> [17.83]		<b>5</b> Aluminium full-ridged without bias		
		<b>144</b> [5.67]	<b>176</b> [6.93]	<b>446</b> [17.56]	<b>478</b> [18.82]				
		<b>146<sup>2)</sup></b> [5.75]	<b>178<sup>2)</sup></b> [7.01]	<b>496</b> [19.53]	<b>528</b> [20.79]		<b>6</b> Aluminium half-ridged with bias		
		<b>158</b> [6.22]	<b>190</b> [7.48]	<b>546</b> [21.50]	<b>578</b> [22.76]				
		<b>164</b> [6.46]	<b>196</b> [7.72]				<b>7</b> Aluminium half-ridged without bias		
		<b>171</b> [6.73]	<b>203</b> [7.99]						
		<b>182<sup>2)</sup></b> [7.17]	<b>214<sup>2)</sup></b> [8.43]				<b>9</b> Special version (on request)		
		<b>196<sup>2)</sup></b> [7.72]	<b>228<sup>2)</sup></b> [8.98]						
		<b>208</b> [8.19]	<b>240</b> [9.45]						
		<b>220<sup>2)</sup></b> [8.66]	<b>252<sup>2)</sup></b> [9.92]						

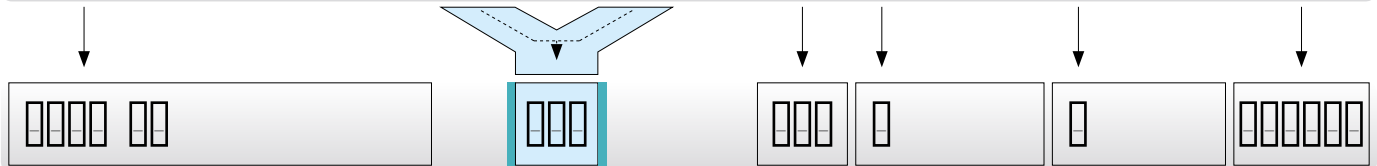

**ORDERING EXAMPLE: 0522 30 220 200 1 3 9555**

Crossbar on outside bend, crossbar on inside bend, can be opened from inside and outside bend  
 Inside width 220 mm, radius 200 mm  
 Plastic crossbar, full-ridged without bias, material is black-coloured polyamide with damper  
 Chain length 9555 mm (105 links)

- <sup>1)</sup> for Variant 30 only
- <sup>2)</sup> also available with plastic cover
- <sup>3)</sup> reduced inner height, reduced max. cable diameter, see chain window drawing on previous page



**NOTE ON CONFIGURATION**

**Aluminium crossbars:**

Aluminium crossbars can be supplied in 1 mm width sizes for inner widths from 67.0 mm – 600.0 mm .

**Aluminium covers:**

Aluminium covers can be supplied in 1 mm width sizes for inner widths from 43.0 mm – 600.0 mm .

**Crossbar connector and crossbar strain relief plate:**

Once inside widths exceed 246 mm, we recommend the deployment of crossbar connectors (RSV). Crossbar connectors cannot be used in conjunction with covers made from plastic or aluminium.

If crossbar strain relief plates (RS-ZL) are to be deployed in the chain brackets, take standard inside widths into account.

For detailed information, please consult the corresponding product documentation.

**SELF-SUPPORTING LENGTH**

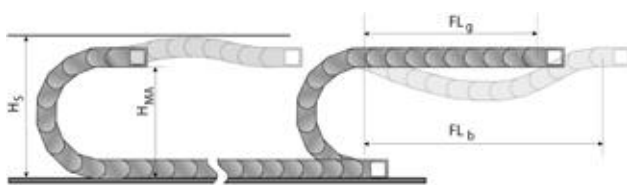

The self-supporting length is the distance between the chain bracket on the moving end and the start of the chain arch. The installation variant  $FL_g$  offers the lowest load and wear for the energy chain. The maximum travel parameters (speed and acceleration) can be applied for this variant.

- $H_s$  = Installation height plus safety
- $H_{MA}$  = Height of moving end connection
- $FL_g$  = Self-supporting length, upper run straight
- $FL_b$  = Self-supporting length, upper run bent

**LOAD DIAGRAM FOR SELF-SUPPORTING APPLICATIONS**

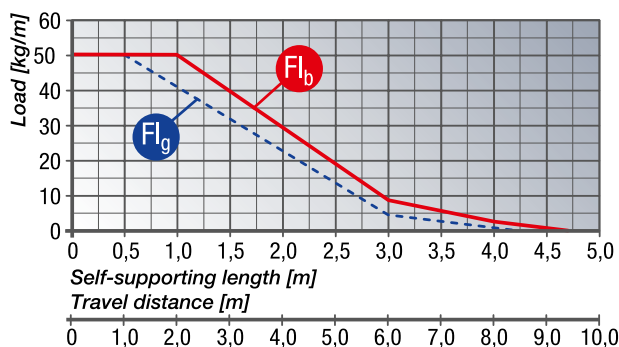

**$FL_g$  Self-supporting length, upper run straight**

In the  $FL_g$  range, the chain upper run still has a bias, is straight or has a maximum sag of 70.0 mm.

**$FL_b$  Self-supporting length, upper run bent**

In the  $FL_b$  range, the chain upper run has a sag of more than 70.0 mm, but this is still less than the maximum sag. Where the sag is greater than that permitted in the  $FL_b$  range, the application is critical and should be avoided. The self-supporting length can be optimised by using a support for the upper run or a more stable energy chain. Closed energy chains (with covers) have a higher unit weight than open chains (with crossbars). This higher weight must be taken into account when calculating the self-supporting length. To the weight of the cabling (cable load, in kg/m), you must add 1.5 kg/m, to account for the higher weight of closed-cover chains.

**DETERMINING THE CHAIN LENGTH**

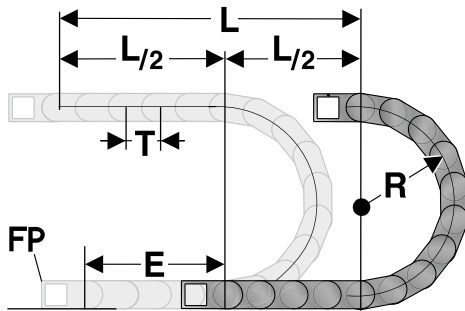

The fixed point of the energy chain should be connected in the middle of the travel distance.

This arrangement gives the shortest connection between the fixed point (FP) and the moving consumer and thus the most efficient chain length.

Chain length calculation =  $L/2 + \pi * R + E$   
 $\approx 1 \text{ m chain} = 11 \text{ qty. } \times 91.0 \text{ mm.}$

- E = Distance between entry point and middle of travel distance
- L = Travel distance
- R = Radius
- P = Pitch 91.0 mm

**INSTALLATION DIMENSIONS**

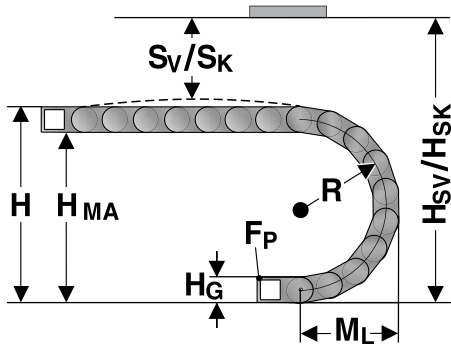

The moving end chain connection is to be screw fixed at height  $H_{MA}$  for the respective radius.

Concerning the installed dimensions, you must take into consideration whether the chain links are equipped with damping elements or not.

For chain links without damping elements, the value “Installed height with bias  $H_{sv}$  without damper” or “Installed height without bias  $H_{sk}$  without damper” must be taken into account. If the chain links are equipped with a damping element, the value “Installed height with bias  $H_{sv}$  with damper” or “Installed height without bias  $H_{sk}$  with damper” is to be taken into account.

<b>Radius R</b>	<b>200</b>
Outside height of chain link ( $H_o$ )	75
Height of bend (H)	505
Height of moving end bracket ( $H_{MA}$ )	430
Safety margin with bias ( $S_v$ )	20
Installation height with bias ( $H_{sv}$ ) with damper	585
Safety margin without bias ( $S_k$ )	20
Installation height without bias ( $H_{sk}$ ) with damper	555
Arc projection ( $M_L$ )	344

**DAMPING ELEMENTS FOR THE SIDE LINKS**

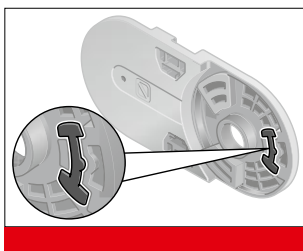

The damping elements in the stops facilitate a significantly quieter unrolling of the chain links. The dampers can be chosen optionally.

A reduction of the noise emission by up to 10 dB(A) comparing to the variants without the use of damping elements is possible.

## POWERLINE PLASTIC CROSSBAR



The crossbars connect the two side runs of the energy chain.  
The crossbar length is synonymous with the inside width of the energy chain.

Type	Order No.	Description	Inside width mm
RS 045-5	052004500000	Crossbar	45.0
RS 057-5	052005700000	Crossbar	57.0
RS 062-5	052006200000	Crossbar	62.0
RS 071-5	052007100000	Crossbar	71.0
RS 084-5	052008400000	Crossbar	84.0
RS 093-5	052009300000	Crossbar	93.0
RS 096-5	052009600000	Crossbar	96.0
RS 104-5	052010400000	Crossbar	104.0
RS 107-5	052010700000	Crossbar	107.0
RS 121-5	052012100000	Crossbar	121.0
RS 133-5	052013300000	Crossbar	133.0
RS 144-5	052014400000	Crossbar	144.0
RS 146-5	052014600000	Crossbar	146.0
RS 158-5	052015800000	Crossbar	158.0
RS 164-5	052016400000	Crossbar	164.0
RS 171-5	052017100000	Crossbar	171.0
RS 182-5	052018200000	Crossbar	182.0
RS 196-5	052019600000	Crossbar	196.0
RS 208-5	052020800000	Crossbar	208.0
RS 220-5	052022000000	Crossbar	220.0
RS 233-5	052023300000	Crossbar	233.0
RS 246-5	052024600000	Crossbar	246.0
RS 252-5	052025200010	Crossbar	252.0
RS 258-5	052025800000	Crossbar	258.0
RS 296-5	052029600000	Crossbar	296.0
RS 346-5	052034600000	Crossbar	346.0
RS 350-5	052035000000	Crossbar	350.0
RS 358-5	052035800000	Crossbar	358.0
RS 371-5	052037100000	Crossbar	371.0
RS 396-5	052039600000	Crossbar	396.0
RS 421-5	052042100000	Crossbar	421.0
RS 446-5	052044600000	Crossbar	446.0
RS 496-5	052049600000	Crossbar	496.0
RS 546-5	052054600000	Crossbar	546.0

**MP 52.3 / MP 52.5 PLASTIC COVER**



The covers connect the two side runs of the energy chain. The cover length is synonymous with the inside width of the energy chain.

Type	Order No.	Description	Installation site	Inside width mm
A-523062, outside	052306210000	Cover	Outside bend	62.0
I-523062, inside	052306220000	Cover	Inside bend	62.0
A-523096, outside	052309610000	Cover	Outside bend	96.0
I-523096, inside	052309620000	Cover	Inside bend	96.0
A-523121, outside	052312110000	Cover	Outside bend	121.0
I-523121, inside	052312120000	Cover	Inside bend	121.0
A-523146, outside	052314610000	Cover	Outside bend	146.0
I-523146, inside	052314620000	Cover	Inside bend	146.0
A-523182, outside	052318210000	Cover	Outside bend	182.0
I-523182, inside	052318220000	Cover	Inside bend	182.0
A-523196, outside	052319610000	Cover	Outside bend	196.0
I-523196, inside	052319620000	Cover	Inside bend	196.0
A-523220, outside	052322010000	Cover	Outside bend	220.0
I-523220, inside	052322020000	Cover	Inside bend	220.0
A-523246, outside	052324610000	Cover	Outside bend	246.0
I-523246, inside	052324620000	Cover	Inside bend	246.0
A-523296, outside	052329610000	Cover	Outside bend	296.0
I-523296, inside	052329620000	Cover	Inside bend	296.0
A-523346, outside	052334610000	Cover	Outside bend	346.0
I-523346, inside	052334620000	Cover	Inside bend	346.0

**KA 52.1 CHAIN BRACKET FLEXIBLE**

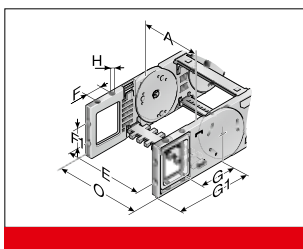

This chain bracket offers universal connection options (top, bottom and front) and is attached to the ends of the chain like a side link. This allows the chain to move right up to the bracket. Each chain requires one male and one female bracket. M8 screws are used to secure the brackets in place. Extrusion-coated metal bushes with either a through-hole (-FB) or a threaded hole (-FG) ensure the permanent, high-strength transmission of even extreme forces onto the energy chain.

Type	Order No.	Material	Version	Inside width							Outside width of KA O mm
				A mm	E mm	F mm	F1 mm	G mm	G1 mm	H mm	
KA 52.1-FB Female end	0521000056	Plastic	with bush	45.0 – 546.0	A+16.0	35.0	30.0	89.0	146.0	8.5	A+36.0
KA 52.1-FB Male end	0521000057	Plastic	with bush	45.0 – 546.0	A+16.0	35.0	30.0	89.0	146.0	8.5	A+36.0
KA 52.1-FG Female end	0521000058	Plastic	with thread	45.0 – 546.0	A+16.0	35.0	30.0	89.0	146.0	M8	A+36.0
KA 52.1-FG Male end	0521000059	Plastic	with thread	45.0 – 546.0	A+16.0	35.0	30.0	89.0	146.0	M8	A+36.0

**KA 52.1 CHAIN BRACKET ANGLE**

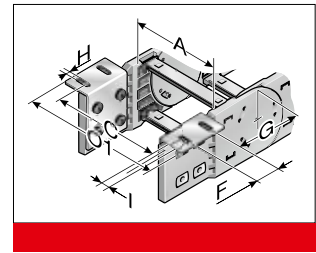
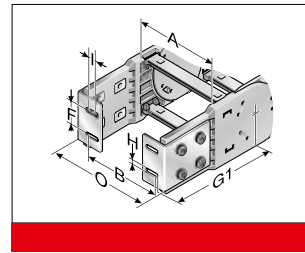
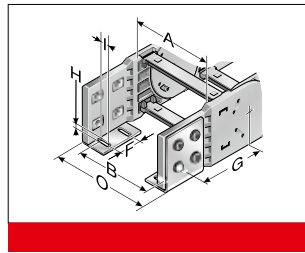
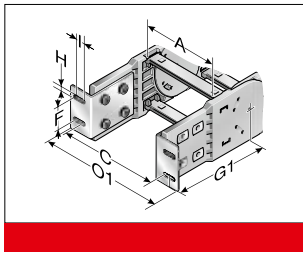

There are several options regarding the chain bracket. The fixed-point bracket (inside/bottom) and the moving end bracket (inside/top) are supplied as standard. However, any other combination can be supplied upon request. The chain bracket is

fastened at the end like a side link. This enables the chain to move right up to the bracket. Each chain requires one male and one female bracket. The brackets should be fastened with M6 screws.

Type	Order No.	Material	Inside width								Outside width of KA 0 mm	Outside width of KA 01 mm
			A mm	B mm	C mm	F mm	G mm	G1 mm	H0 mm	I mm		
KA 52.1 Female end	0521000050	Sheet steel	45.0 – 546.0	A-2.5	A+34.5	32.0	95.5	144.0	6.5	14.0	A+32.0	A+71.0
KA 52.1 Male end	0521000051	Sheet steel	45.0 – 546.0	A-2.5	A+34.5	32.0	95.5	144.0	6.5	14.0	A+32.0	A+71.0

**GS 52.2 SLIDING BLOCK**

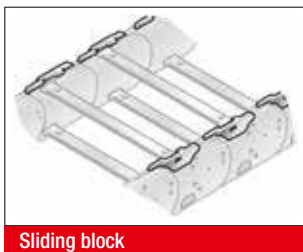

Sliding block

In the case of energy chains, sliding blocks are used in a horizontally sliding installation mode (the tight side of the chain slides on the slack side). The sliding blocks are set onto the side links on the interior bend instead of the usual crossbar interlocks; (no tools needed). This forces the chain to slide on the sliding blocks instead on the side links of the chain. Depending on the application, the service life of the energy chain may be extended five-fold, by using slide blocks. Information about the minimum bending radius of the energy chain at the sliding block insert is listed in the following table.

Type	Order No.	Installation site	Min. radius mm	Sliding block height mm
GS 52.2.1 right	052290400302	For right side link	150.0	4.0
GS 52.2.2 left	052290400300	For left side link	150.0	4.0

**GLP 52.2-D GLIDING PLATE**

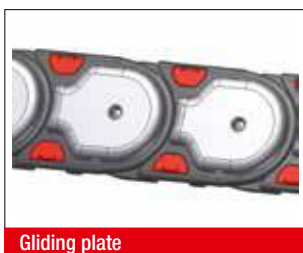

Gliding plate

The gliding plates are mounted in a horizontal position, with the chain laying on its side, to minimize friction wear to the sides. They are mounted to the side links using a special screw. The wear limit is 2.5 mm. We recommend replacing the energy chain when this limit has been reached. Depending on the application, the service life of the energy chain may be extended two-fold, by using gliding plates. The energy chain must be placed on its side before opening.

Type	Order No.	Installation site	For radius mm	Gliding plate height mm
SG 52.2-D RK200.2 right with GLP5, mounted	052200020096	Right chain link including gliding plate	200.0	7.0
SG 52.2-D RK200.2 left with GLP5, mounted	052200020094	Left chain link including gliding plate	200.0	7.0

**TR 52 SEPARATOR**

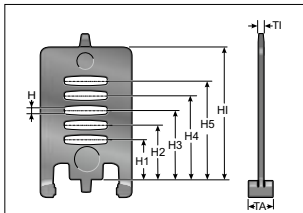

Separator

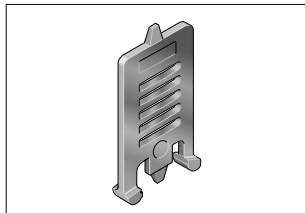

Separator

We recommend that separators be used if multiple round cables or conduits with differing diameters are to be installed. The closed separator is used when no shelves are used. This is the recommended design for travel paths of 30 metres or greater.

Type	Order No.	Description	Version	Tl mm	TA mm	H mm	H1 mm	H2 mm	H3 mm	H4 mm	H5 mm	Hl mm
TR 52	052000009200	TR 52 Separator	lockable	3.5	10.0	4.2	16.3	22.3	28.2	33.8	39.8	52.0

**TR 52.1 SEPARATOR**

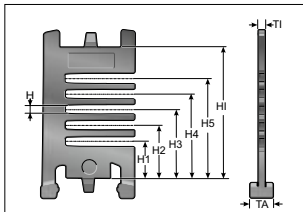

Separator

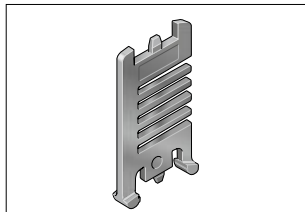

Separator

We recommend that separators be used if multiple round cables or conduits with differing diameters are to be installed.

Type	Order No.	Description	Version	Tl mm	TA mm	H mm	H1 mm	H2 mm	H3 mm	H4 mm	H5 mm	Hl mm
TR 52.1	052100009200	TR 52.1 Separator	lockable	3.5	8.0	4.0	15.6	22.0	28.2	34.6	41.0	52.0

**TR 52-V SEPARATOR**

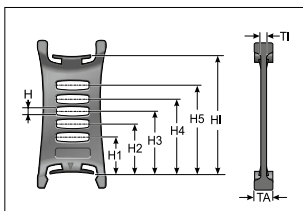

Separator

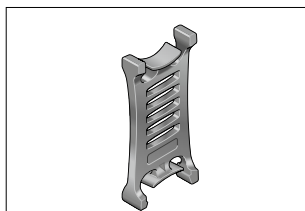

Separator

We recommend that separators be used if multiple round cables or conduits with differing diameters are to be installed.

Type	Order No.	Description	Version	Tl mm	TA mm	H mm	H1 mm	H2 mm	H3 mm	H4 mm	H5 mm	Hl mm
TR 52-V	052000009300	TR 52-V Separator	moveable	3.5	13.0	4.0	16.3	22.3	28.2	33.8	39.8	52.0

**RTT 52 SHELF SUPPORT, DIVISIBLE**

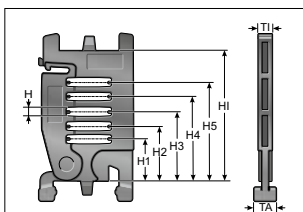

Shelf support

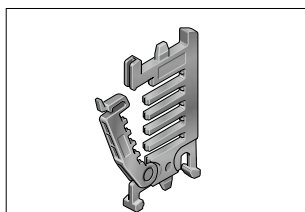

Shelf support

In connection with two separable shelf supports (RTT) with at least one end-to-end shelf (RB) the shelf becomes an easy to fill shelving system. The additional levels prevent cables from criss-crossing and minimise the friction between them.

Type	Order No.	Description	Version	Tl mm	TA mm	H mm	H1 mm	H2 mm	H3 mm	H4 mm	H5 mm	Hl mm
RTT 52	100090522000	Shelf support, divisible	lockable	7.0	8.0	4.0	15.6	22.0	28.2	34.6	41.0	52.0

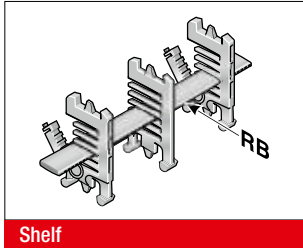
**RB-5 SHELF**

In connection with at least two separable shelf supports (RTT), the shelf becomes a shelving system. The additional levels prevent cables from criss-crossing and minimise the friction between them.

Type	Order No.	Description	Width mm	Inside width mm
RB 028-5	10000002800	Shelf	28.0	45.0
RB 034-5	1000003405	Shelf	33.6	45.0
RB 039-5	1000003905	Shelf	39.2	45.0
RB 045-5	1000004505	Shelf	44.8	57.0
RB 050-5	1000005005	Shelf	50.4	57.0
RB 056-5	10000005601	Shelf	56.0	62.0
RB 062-5	1000006205	Shelf	61.6	62.0
RB 067-5	1000006705	Shelf	67.2	84.0
RB 073-5	1000007305	Shelf	72.8	84.0
RB 078-5	1000007805	Shelf	78.4	84.0
RB 084-5	10000008400	Shelf	84.0	84.0
RB 090-5	1000009005	Shelf	89.6	96.0
RB 095-5	1000009505	Shelf	95.2	96.0
RB 101-5	1000010105	Shelf	100.8	107.0
RB 106-5	1000010605	Shelf	106.4	107.0
RB 112-5	100000011200	Shelf	112.0	121.0
RB 118-5	1000011805	Shelf	117.6	121.0
RB 123-5	1000012305	Shelf	123.2	133.0
RB 129-5	1000012905	Shelf	128.8	133.0
RB 134-5	1000013405	Shelf	134.4	144.0
RB 140-5	100000014000	Shelf	140.0	144.0
RB 146-5	1000014605	Shelf	145.6	158.0
RB 151-5	1000015105	Shelf	151.2	158.0
RB 157-5	1000015705	Shelf	156.8	164.0
RB 162-5	1000016205	Shelf	162.4	164.0
RB 168-5	100000016800	Shelf	168.0	182.0
RB 174-5	1000017405	Shelf	173.6	182.0
RB 179-5	1000017905	Shelf	179.2	196.0
RB 185-5	1000018505	Shelf	184.8	196.0
RB 190-5	1000019005	Shelf	190.4	196.0
RB 196-5	100000019600	Shelf	196.0	196.0
RB 291-5	100000029100	Shelf	291.2	346.0

### RSV 52 CROSSBAR CONNECTOR



For crossbars wider than 246 mm, we recommend the use of crossbar connectors. These prevent deformation to the crossbar under large amounts of additional weight of the chain assembly.

Type	Order No.	Description	Tl mm
RSV 52	052000009600	Crossbar connector	7.5
RSV 52 Alu	052000009800	Crossbar connector for aluminium crossbars	7.5

### RE 52 H-SHAPED SHELF UNIT

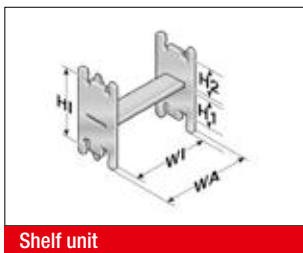

One-piece shelving system, the shelf cannot be varied in height.

Type	Order No.	Description	WA mm	WI mm	H1 mm	H2 mm	H3 mm
RE 36/17	100000361714	H-shaped shelf unit	42.5	36.5	31.0	17.4	52.0
RE 59/24	100000592414	H-shaped shelf unit	65.0	59.0	24.2	24.2	52.0
RE 81/12	100000811214	H-shaped shelf unit	87.5	81.5	36.0	12.4	52.0

### BS-5 BRACKET BAR



Large-diameter conduits are routed securely by using a bracket bar (BS). This bar is installed on the crossbars or the covers of the energy chain.

The bracket bar can be installed on both the inside and outside bend.

The bracket bar support (BSH) is used to attach the bars to PowerLine series crossbars. Two bracket bar supports are required for each bar.

Type	Order No.	Description	Conduit diameter max. mm	Installation height mm	Inner chain width min. mm
BS 120-5	052412000000	Bracket bar	115.0	140.0	164.0
BS 153-5	052415300000	Bracket bar	148.0	170.0	208.0
BS 187-5	052418700000	Bracket bar	182.0	205.0	233.0
BSH-5	052400000000	Bracket bar support			
Assembly set	052400000001	Assembly set			



**D5 CHAIN BRACKET COVER**

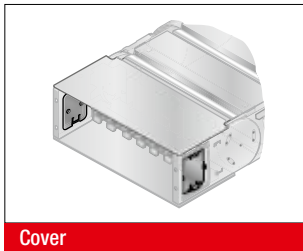

Self-locking covers close the side mounting window on the flexible chain bracket (KA-FB/FG).

Type	Order No.
D5 Cover	0523888002

**MP 52.3 CHAIN BRACKET CANOPY**

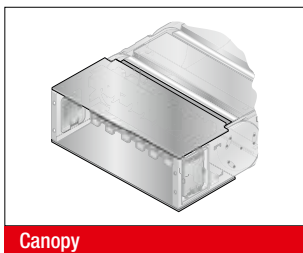

Constructed from aluminium, the canopies for the flexible chain bracket (KA-FB/FG) ensure a continuously closed system for chains with covers.

**Canopy for chain bracket fixed point outside bend: Type and order number configurator**



Type:	KA 52.1 FB/FG AB	Inside width	2-2
Order No.:	0521	Inside width	060

**Canopy for chain bracket fixed point inside bend: Type and order number configurator**



Type:	KA 52.1 FB/FG IB	Inside width	2-2
Order No.:	0521	Inside width	058

**Canopy for chain bracket moving end outside bend: Type and order number configurator**



Type:	KA 52.1 FB/FG AB	Inside width	1-2
Order No.:	0521	Inside width	059

**Canopy for chain bracket moving end inside bend: Type and order number configurator**



Type:	KA 52.1 FB/FG IB	Inside width	1-2
Order No.:	0521	Inside width	057

**Ordering example:**

0521096058 KA 52.1 FB/FG IB 096 2-2

Chain bracket canopy at fixing point in inside bend, for inside width of 96 mm.

**RS-ZL-5 CROSSBAR STRAIN RELIEF PLATE**

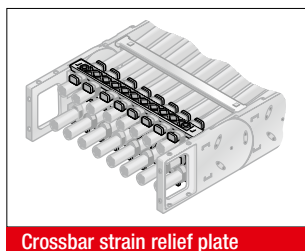

Crossbar strain relief plate

Fixed integrated frame bridge strain relief plates in the chain brackets. Tailored to all crossbar widths up to 246 mm. May be assembled on the inside and outside bends at both chain endings.

Type	Order No.	Description	Inside width mm
RS-ZL 045-5	052004500010	Crossbar strain relief plate	45.0
RS-ZL 057-5	052005700010	Crossbar strain relief plate	57.0
RS-ZL 062-5	052006200010	Crossbar strain relief plate	62.0
RS-ZL 071-5	052007100010	Crossbar strain relief plate	71.0
RS-ZL 084-5	052008400010	Crossbar strain relief plate	84.0
RS-ZL 093-5	052009300010	Crossbar strain relief plate	93.0
RS-ZL 096-5	052009600010	Crossbar strain relief plate	96.0
RS-ZL 104-5	052010400010	Crossbar strain relief plate	104.0
RS-ZL 107-5	052010700010	Crossbar strain relief plate	107.0
RS-ZL 121-5	052012100010	Crossbar strain relief plate	121.0
RS-ZL 133-5	052013300010	Crossbar strain relief plate	133.0
RS-ZL 144-5	052014400010	Crossbar strain relief plate	144.0
RS-ZL 146-5	052014600010	Crossbar strain relief plate	146.0
RS-ZL 158-5	052015800010	Crossbar strain relief plate	158.0
RS-ZL 164-5	052016400010	Crossbar strain relief plate	164.0
RS-ZL 171-5	052017100010	Crossbar strain relief plate	171.0
RS-ZL 182-5	052018200010	Crossbar strain relief plate	182.0
RS-ZL 196-5	052019600010	Crossbar strain relief plate	196.0
RS-ZL 208-5	052020800010	Crossbar strain relief plate	208.0
RS-ZL 220-5	052022000010	Crossbar strain relief plate	220.0
RS-ZL 233-5	052023300010	Crossbar strain relief plate	233.0
RS-ZL 246-5	052024600010	Crossbar strain relief plate	246.0

**MP 52/62/72 LOCK BUTTON**

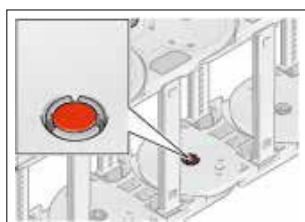

Lock button

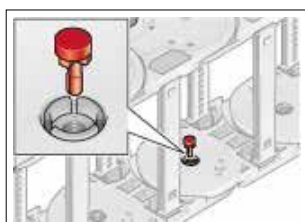

Lock button

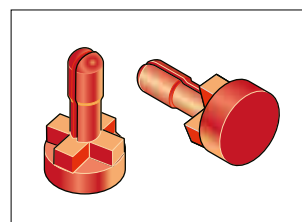

Lock button

To increase the side stability, we recommend the use of lock buttons during strong lateral acceleration or when installed

“laying on the side (turned 90°) without support”.

Type	Order No.
MP52/62/72 lock button	0520000080

**STRAIN RELIEF WITH STEEL FIX**

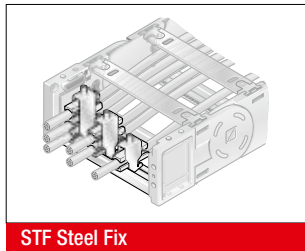
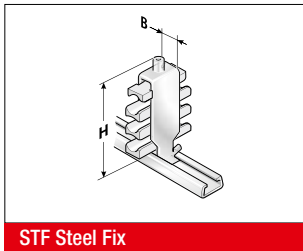

C-rails (galvanised) for permanent integration, for accommodating the Steel Fix bow clamps in the chain brackets. The bow clamps can take up to 3 cables and are suitable for C-rails with a groove width of 11 mm. Due to the design of the trough elements, a cable preserving cable guidance is ensured. May be assembled on the inside and outside bends at both chain endings. The overall height stated is a guide only. The actual height is, amongst other things, dependent on the diameter and the quality of the cable. A safety distance of 10 mm at the fixed point above the strain relief must be kept during gliding applications.

Type	Order No.	Description	Seats qty.	Cable Ø mm	Width mm	Total height (H) mm
<b>Single clamp (for one cable)</b>						
STF 12-1 Steel Fix	81661801	Hooped clamp	1	6.0 – 12.0	16.0	55.0
STF 14-1 Steel Fix	81661802	Hooped clamp	1	12.0 – 14.0	18.0	52.0
STF 16-1 Steel Fix	81661803	Hooped clamp	1	14.0 – 16.0	20.0	54.0
STF 18-1 Steel Fix	81661804	Hooped clamp	1	16.0 – 18.0	22.0	56.0
STF 20-1 Steel Fix	81661805	Hooped clamp	1	18.0 – 20.0	24.0	59.0
STF 22-1 Steel Fix	81661806	Hooped clamp	1	20.0 – 22.0	26.0	61.0
STF 26-1 Steel Fix	81661807	Hooped clamp	1	22.0 – 26.0	30.0	70.0
STF 30-1 Steel Fix	81661808	Hooped clamp	1	26.0 – 30.0	34.0	74.0
STF 34-1 Steel Fix	81661809	Hooped clamp	1	30.0 – 34.0	38.0	78.0
STF 38-1 Steel Fix	81661810	Hooped clamp	1	34.0 – 38.0	42.0	82.0
STF 42-1 Steel Fix	81661811	Hooped clamp	1	38.0 – 42.0	46.0	91.0
<b>Double clamp (for two cables)</b>						
STF 12-2 Steel Fix	81661821	Hooped clamp	2	6.0 – 12.0	16.0	73.0
STF 14-2 Steel Fix	81661822	Hooped clamp	2	12.0 – 14.0	18.0	74.0
STF 16-2 Steel Fix	81661823	Hooped clamp	2	14.0 – 16.0	20.0	82.0
STF 18-2 Steel Fix	81661824	Hooped clamp	2	16.0 – 18.0	22.0	86.0
STF 20-2 Steel Fix	81661825	Hooped clamp	2	18.0 – 20.0	24.0	91.0
STF 22-2 Steel Fix	81661826	Hooped clamp	2	20.0 – 22.0	26.0	95.0
STF 26-2 Steel Fix	81661827	Hooped clamp	2	22.0 – 26.0	30.0	108.0
STF 30-2 Steel Fix	81661828	Hooped clamp	2	26.0 – 30.0	34.0	121.0
STF 34-2 Steel Fix	81661829	Hooped clamp	2	30.0 – 34.0	38.0	129.0
<b>Triple clamp (for three cables)</b>						
STF 12-3 Steel Fix	81661841	Hooped clamp	3	6.0 – 12.0	16.0	98.0
STF 14-3 Steel Fix	81661842	Hooped clamp	3	12.0 – 14.0	18.0	98.0
STF 16-3 Steel Fix	81661843	Hooped clamp	3	14.0 – 16.0	20.0	105.0
STF 18-3 Steel Fix	81661844	Hooped clamp	3	16.0 – 18.0	22.0	111.0
STF 20-3 Steel Fix	81661845	Hooped clamp	3	18.0 – 20.0	24.0	118.0
STF 22-3 Steel Fix	81661846	Hooped clamp	3	20.0 – 22.0	26.0	130.0

**MP 52-D LOWERED FIXING POINT**

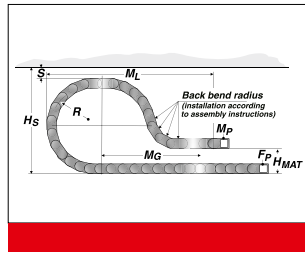
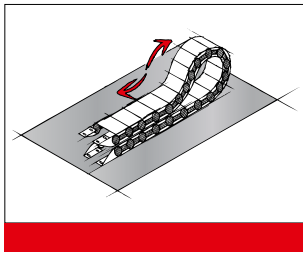

It is sometimes necessary to lower the height of the moving attachment point.

In such cases, modifications to the chain layout should be noted (e.g. extension of chain).

Please contact our application engineers.

Radius R mm	Height of moving end bracket (H <sub>MA</sub> ) mm	Safety margin (S) mm	Installation height incl. safety (H <sub>S</sub> ) mm	Projection (M <sub>L</sub> ) mm	Additional links qty.	of which additional back chain links qty.
200.0	210.0	50.0	565.0	830.0	10	3

**MP 52.2-D REARWARD RADII**

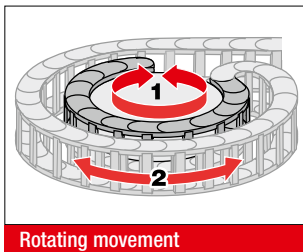

Rotating movement

Side links with rearward radius allow movements in both directions. This is intended for rotating movements and lowered chain brackets. Note: This type of chain has different chain links for the left or right side! Rotation movements are only possible with open variants.

Type	Order No.	Radius mm	Rearward radius mm
SR 52.2 (RÜ200/R200) left	SR 52.2-D (RÜ200/R200) links	200.0	200.0
SR 52.2 (RÜ200/R200) right	SR 52.2-D (RÜ200/R200) rechts	200.0	200.0

**GUIDE CHANNEL VAW (ALUMINIUM / STAINLESS STEEL)**



VAW steel galvanised / stainless steel



VAW aluminium

A range of variable guide channel systems, constructed from aluminium or stainless steel sections, are available for this energy chain.

The variable guide channel ensures that the energy chain is supported and guided securely.

**ASSEMBLY INSTRUCTION FLEXIBLE CHAIN BRACKET FB/FG**

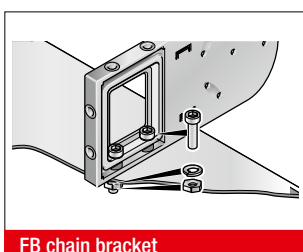

FB chain bracket

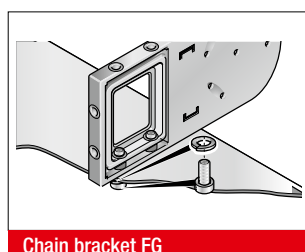

Chain bracket FG

Brass bushes guarantee long-lasting fastening without cold flow in the plastic.

**Version KA-FB:**

Integrated through-hole fastened down using screw and nut.

**Version KA-FG:**

Built-in threads allow for quick and easy on-site mounting, since a screw, including a retaining washer where necessary, is sufficient.

**ASSEMBLY**

**DISASSEMBLY**

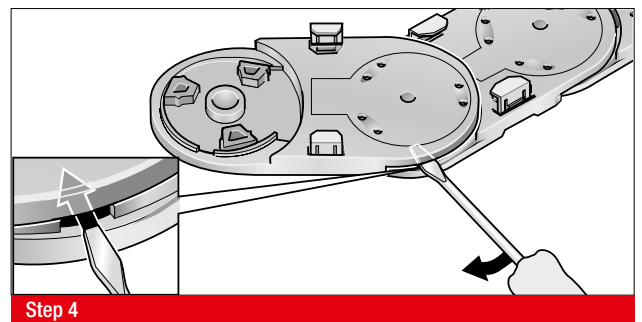
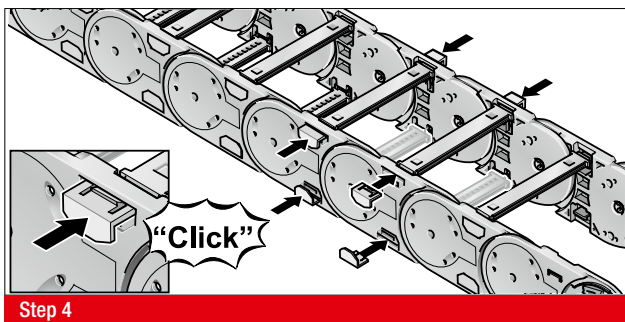
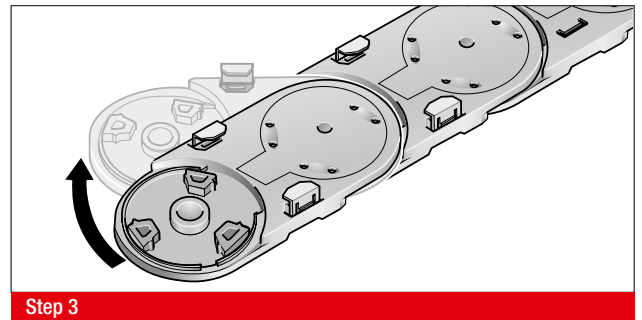
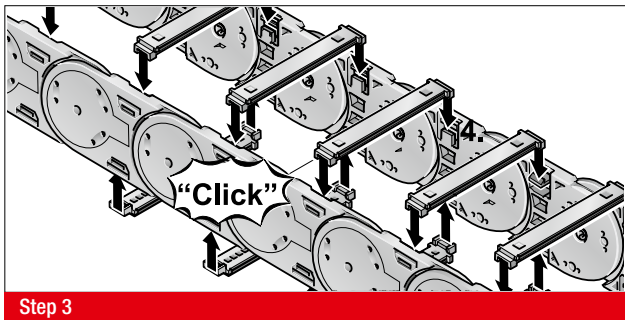
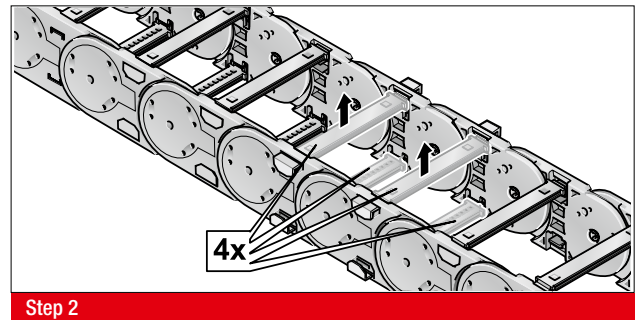
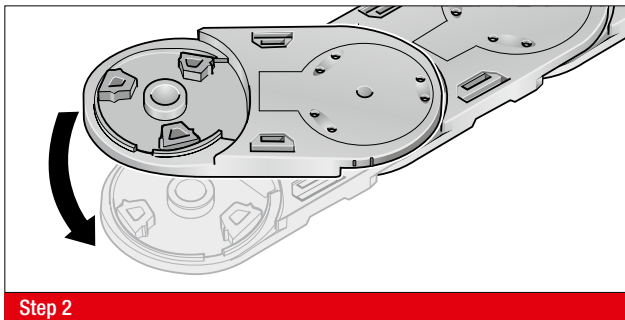
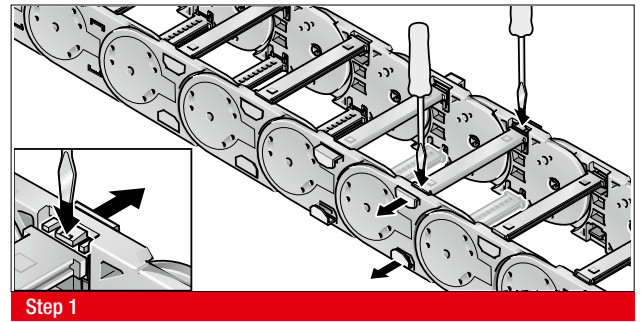
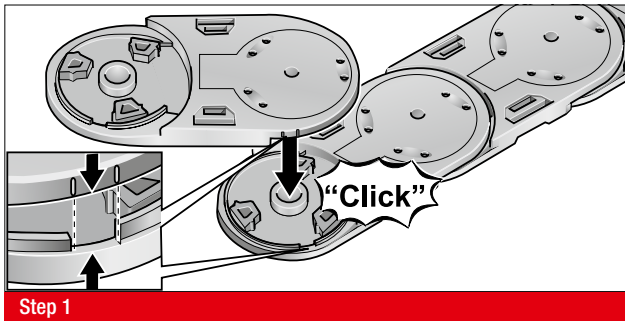

**MP 52.4**  
OPEN



**MP 52.5**  
CLOSED

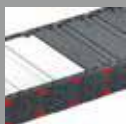

- LOW-COST VARIANT
- SOFT-STOP SYSTEM
- CHAIN BRACKET FLEXIBLE
- BROAD INTERIOR LAYOUT
- PLASTIC OR ALUMINIUM VERSION

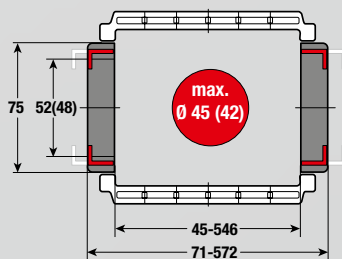

## TECHNICAL DATA

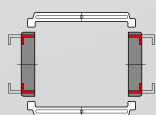

**Loading side**  
Inside and outside bend

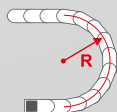

**Available radii**  
125.0 – 300.0

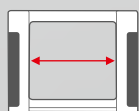

**Available interior widths**  
With plastic crossbar  
45.0 – 546.0  
With alu crossbar / with alu cover  
67.0 – 600.0 mm / 43.0 – 600.0 mm

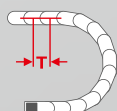

**Pitch**  
T = 91.0 mm



**Noise attenuator**  
Reduction of the noise emission by up to 10 dB(A) by the use of damping elements in the chain links.

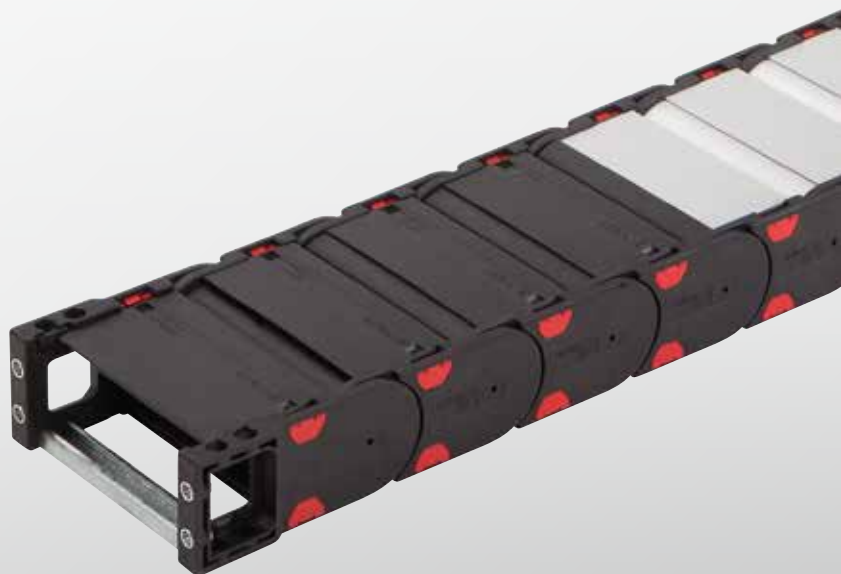



## TECHNICAL SPECIFICATIONS

Travel distance gliding $L_g$ max.	50.0 m
Travel distance self-supporting $L_s$ max.	see diagram on page 253
Travel distance vertical, hanging $L_{vh}$ max.	50.0 m
Travel distance vertical, upright $L_{vs}$ max.	4.0 m
Rotated 90°, unsupported $L_{90f}$ max.	1.0 m
Speed, gliding $V_g$ max.	5.0 m/s
Speed, self-supporting $V_f$ max.	20.0 m/s
Acceleration, gliding $a_g$ max.	25.0 m/s <sup>2</sup>
Acceleration, self-supporting $a_s$ max.	30.0 m/s <sup>2</sup>

Contact our engineering department to meet any higher requirements: [efk@murrplastik.de](mailto:efk@murrplastik.de)

## MATERIAL PROPERTIES

Standard material	Polyamide (PA) black
Service temperature	-30.0 – 120.0 °C
Gliding friction factor	0.3
Static friction factor	0.45
Fire classification	UL 94 HB

Other material properties on request.

## ACCESSORIES



Sliding block

## SHELVING SYSTEM



Separator TR

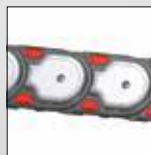

Gliding plate

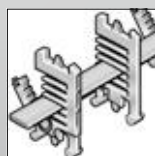

RS shelving system



Bracket bar

## CHAIN BRACKET



Crossbar connector RSV



Cover

## GUIDE CHANNELS



VAW steel galvanised / stainless steel



RS-ZL crossbar strain relief

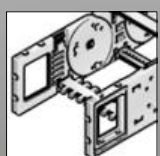

Chain bracket flexible

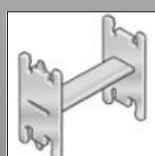

H-shaped shelf unit RE

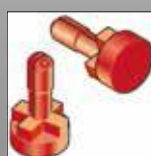

Lock button

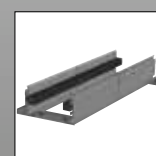

VAW aluminium

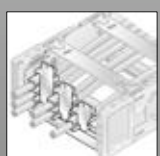

STF Steel Fix

ORDERING KEY

Dimensions in mm [US inch]

Type code	Variation	Inside width	Outside width	Inside width	Outside width	Radius	Crossbar variant	Material	Chain length
0524 30	MP 52.4 open Crossbar on outside bend Crossbar on inside bend Opens on inside and outside bend	045 <sup>1)</sup> [1.77]	071 [2.80]	233 [9.17]	259 [10.20]	125 <sup>1)</sup> [4.92]	0 Plastic, full-ridged with bias	2 Polyamide without attenuator (PA/black)	
		057 <sup>1)</sup> [2.24]	083 [3.27]	246 <sup>2)</sup> [9.69]	272 [10.71]				
0525 44 <sup>3)</sup>	MP 52.5 Closed Cover on outside bend Cover on inside bend Opens on inside and outside bend	062 <sup>1)</sup> [2.44]	088 [3.46]	252 [9.92]	278 [10.94]	135 <sup>1)</sup> [5.31]	1 Plastic, full-ridged without bias	3 Polyamide with attenuator (PA/black)	
		071 [2.80]	097 [3.82]	258 [10.16]	284 [11.18]				
		084 [3.31]	110 [4.33]	296 <sup>2)</sup> [11.65]	322 [12.68]	150 [5.91]	2 Plastic, half-ridged with bias	9 Special version (on request)	
		093 [3.66]	119 [4.69]	346 <sup>2)</sup> [13.62]	372 [14.65]				
		096 <sup>2)</sup> [3.78]	122 [4.80]	350 [13.78]	376 [14.80]	175 [6.89]	3 Plastic, half-ridged without bias		
		104 [4.09]	130 [5.12]	358 [14.09]	384 [15.12]				
		107 [4.21]	133 [5.24]	371 [14.61]	397 [15.63]	200 [7.87]	4 Aluminium full-ridged with bias		
		121 <sup>2)</sup> [4.76]	147 [5.79]	396 [15.59]	422 [16.61]				
		133 [5.24]	159 [6.26]	421 [16.57]	447 [17.60]	250 [9.84]	5 Aluminium full-ridged without bias		
		144 [5.67]	170 [6.69]	446 [17.56]	472 [18.58]				
		146 <sup>2)</sup> [5.75]	172 [6.77]	496 [19.53]	522 [20.55]	300 [11.81]	6 Aluminium half-ridged with bias		
		158 [6.22]	184 [7.24]	546 [21.50]	572 [22.52]				
		164 [6.46]	190 [7.48]				7 Aluminium half-ridged without bias		
		171 [6.73]	197 [7.76]						
		182 <sup>2)</sup> [7.17]	208 [8.19]				9 Special version (on request)		
		196 <sup>2)</sup> [7.72]	222 [8.74]						
		208 [8.19]	234 [9.21]						
		220 <sup>2)</sup> [8.66]	246 [9.69]						



ORDERING EXAMPLE: 0524 30 220 150 0 3 2500

Crossbar on outside bend, crossbar on inside bend, can be opened from inside and outside bend  
 Inside width 220 mm, radius 150 mm  
 Plastic, full-ridged with bias, material polyamide with damper (PA/black)  
 Chain length 2500 mm (28 links)

- <sup>1)</sup> Only for variant MP 52.4
- <sup>2)</sup> MP 52.5 also available with plastic cover
- <sup>3)</sup> Reduced inner height, reduced max. cable diameter, see chain window drawing on previous page



**NOTE ON CONFIGURATION**

**Aluminium crossbars:**

Aluminium crossbars can be supplied in 1 mm width sizes for inner widths from 67.0 mm – 600.0 mm .

**Aluminium covers:**

Aluminium covers can be supplied in 1 mm width sizes for inner widths from 43.0 mm – 600.0 mm .

**Crossbar connector and crossbar strain relief plate:**

Once inside widths exceed 246 mm, we recommend the deployment of crossbar connectors (RSV).  
Crossbar connectors cannot be used in conjunction with covers made from plastic or aluminium.

If crossbar strain relief plates (RS-ZL) are to be deployed in the chain brackets, take standard inside widths into account.

For detailed information, please consult the corresponding product documentation.

**SELF-SUPPORTING LENGTH**

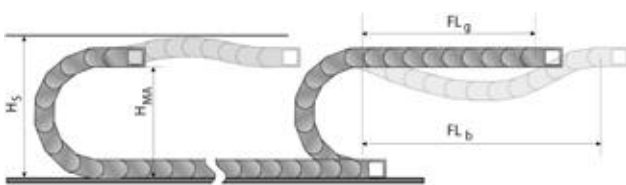

The self-supporting length is the distance between the chain bracket on the moving end and the start of the chain arch.  
The installation variant  $FL_g$  offers the lowest load and wear for the energy chain.  
The maximum travel parameters (speed and acceleration) can be applied for this variant.

- $H_s$  = Installation height plus safety
- $H_{MA}$  = Height of moving end connection
- $FL_g$  = Self-supporting length, upper run straight
- $FL_b$  = Self-supporting length, upper run bent

**LOAD DIAGRAM FOR SELF-SUPPORTING APPLICATIONS**

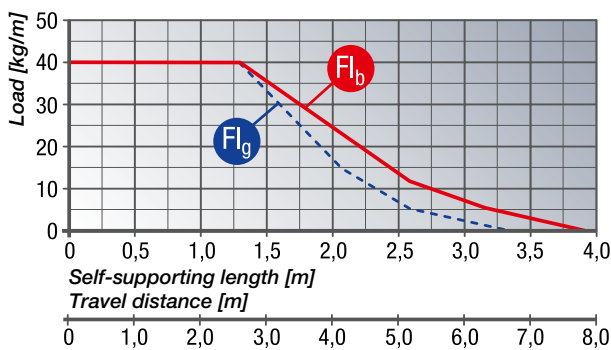

**FL<sub>g</sub> Self-supporting length, upper run straight**

In the  $FL_g$  range, the chain upper run still has a bias, is straight or has a maximum sag of 70.0 mm.

**FL<sub>b</sub> Self-supporting length, upper run bent**

In the  $FL_b$  range, the chain upper run has a sag of more than 70.0 mm, but this is still less than the maximum sag.  
Where the sag is greater than that permitted in the  $FL_b$  range, the application is critical and should be avoided. The self-supporting length can be optimised by using a support for the upper run or a more stable energy chain.  
Closed cable drag chains (with covers) have a higher unit weight than open chains (with frame bridges). This higher weight must be taken into account when calculating the self-supporting length. To the weight of the cabling (cable load, in kg/m), you must add 1.5 kg/m, to account for the higher weight of closed-cover chains.

**DETERMINING THE CHAIN LENGTH**

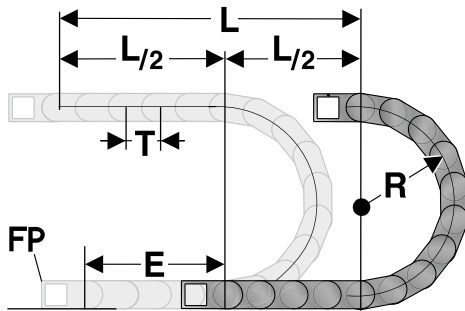

The fixed point of the energy chain should be connected in the middle of the travel distance. This arrangement gives the shortest connection between the fixed point (FP) and the moving consumer and thus the most efficient chain length.

Chain length calculation =  $L/2 + \pi * R + E$   
 $\approx 1 \text{ m chain} = 11 \text{ qty. x91.0 mm.}$

- E = Distance between entry point and middle of travel distance
- L = Travel distance
- R = Radius
- P = Pitch 91.0 mm

**INSTALLATION DIMENSIONS**

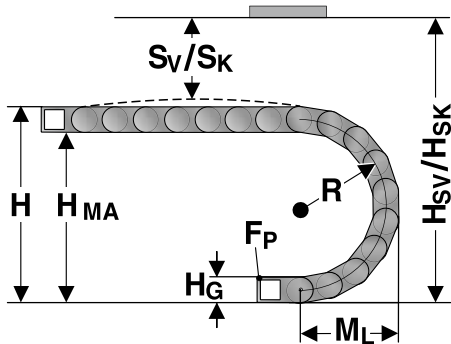

The moving end chain connection is to be screw fixed at height  $H_{MA}$  for the respective radius. Concerning the installed dimensions, you must take into consideration whether the chain links are equipped with damping elements or not. For chain links without damping elements, the value “Installed height with bias  $H_{sv}$  without damper” or “Installed height without bias  $H_{sk}$  without damper” must be taken into account. If the chain links are equipped with a damping element, the value “Installed height with bias  $H_{sv}$  with damper” or “Installed height without bias  $H_{sk}$  with damper” is to be taken into account.

Radius R	125	135	150	175	200	250	300
Outside height of chain link ( $H_o$ )	75	75	75	75	75	75	75
Height of bend (H)	325	345	375	425	475	575	675
Height of moving end bracket ( $H_{MA}$ )	250	270	300	350	400	500	600
Safety margin with bias ( $S_v$ )	20	20	20	20	20	20	20
Installation height with bias ( $H_{sv}$ ) without damper	405	425	455	505	555	655	755
Installation height with bias ( $H_{sv}$ ) with damper	435	455	485	535	585	685	785
Safety margin without bias ( $S_k$ )	20	20	20	20	20	20	20
Installation height without bias ( $H_{sk}$ ) without damper	345	365	395	445	495	595	695
Installation height without bias ( $H_{sk}$ ) with damper	375	395	425	475	525	625	725
Arc projection ( $M_L$ )	254	264	279	304	329	379	429

**DAMPING ELEMENTS FOR THE SIDE LINKS**

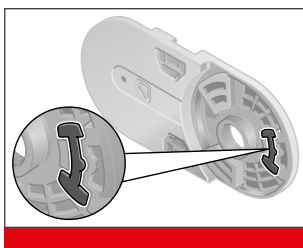

The damping elements in the stops facilitate a significantly quieter unrolling of the chain links. The dampers can be chosen optionally. A reduction of the noise emission by up to 10 dB(A) comparing to the variants without the use of damping elements is possible.

## POWERLINE PLASTIC CROSSBAR



The crossbars connect the two side runs of the energy chain. The crossbar length is synonymous with the inside width of the energy chain.

Type	Order No.	Description	Inside width mm
RS 045-5	052004500000	Crossbar	45.0
RS 057-5	052005700000	Crossbar	57.0
RS 062-5	052006200000	Crossbar	62.0
RS 071-5	052007100000	Crossbar	71.0
RS 084-5	052008400000	Crossbar	84.0
RS 093-5	052009300000	Crossbar	93.0
RS 096-5	052009600000	Crossbar	96.0
RS 104-5	052010400000	Crossbar	104.0
RS 107-5	052010700000	Crossbar	107.0
RS 121-5	052012100000	Crossbar	121.0
RS 133-5	052013300000	Crossbar	133.0
RS 144-5	052014400000	Crossbar	144.0
RS 146-5	052014600000	Crossbar	146.0
RS 158-5	052015800000	Crossbar	158.0
RS 164-5	052016400000	Crossbar	164.0
RS 171-5	052017100000	Crossbar	171.0
RS 182-5	052018200000	Crossbar	182.0
RS 196-5	052019600000	Crossbar	196.0
RS 208-5	052020800000	Crossbar	208.0
RS 220-5	052022000000	Crossbar	220.0
RS 233-5	052023300000	Crossbar	233.0
RS 246-5	052024600000	Crossbar	246.0
RS 252-5	052025200010	Crossbar	252.0
RS 258-5	052025800000	Crossbar	258.0
RS 296-5	052029600000	Crossbar	296.0
RS 346-5	052034600000	Crossbar	346.0
RS 350-5	052035000000	Crossbar	350.0
RS 358-5	052035800000	Crossbar	358.0
RS 371-5	052037100000	Crossbar	371.0
RS 396-5	052039600000	Crossbar	396.0
RS 421-5	052042100000	Crossbar	421.0
RS 446-5	052044600000	Crossbar	446.0
RS 496-5	052049600000	Crossbar	496.0
RS 546-5	052054600000	Crossbar	546.0

**MP 52.3 / MP 52.5 PLASTIC COVER**



The covers connect the two side runs of the energy chain. The cover length is synonymous with the inside width of the energy chain.

Type	Order No.	Description	Installation site	Inside width mm
A-523062, outside	052306210000	Cover	Outside bend	62.0
I-523062, inside	052306220000	Cover	Inside bend	62.0
A-523096, outside	052309610000	Cover	Outside bend	96.0
I-523096, inside	052309620000	Cover	Inside bend	96.0
A-523121, outside	052312110000	Cover	Outside bend	121.0
I-523121, inside	052312120000	Cover	Inside bend	121.0
A-523146, outside	052314610000	Cover	Outside bend	146.0
I-523146, inside	052314620000	Cover	Inside bend	146.0
A-523182, outside	052318210000	Cover	Outside bend	182.0
I-523182, inside	052318220000	Cover	Inside bend	182.0
A-523196, outside	052319610000	Cover	Outside bend	196.0
I-523196, inside	052319620000	Cover	Inside bend	196.0
A-523220, outside	052322010000	Cover	Outside bend	220.0
I-523220, inside	052322020000	Cover	Inside bend	220.0
A-523246, outside	052324610000	Cover	Outside bend	246.0
I-523246, inside	052324620000	Cover	Inside bend	246.0
A-523296, outside	052329610000	Cover	Outside bend	296.0
I-523296, inside	052329620000	Cover	Inside bend	296.0
A-523346, outside	052334610000	Cover	Outside bend	346.0
I-523346, inside	052334620000	Cover	Inside bend	346.0

**KA 52.4 CHAIN BRACKET FLEXIBLE**

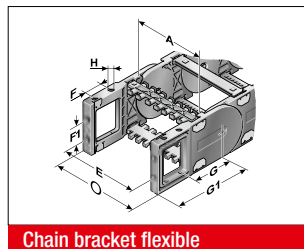
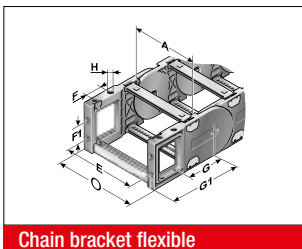

This chain bracket offers universal connection options (top, bottom and front) and is attached to the ends of the energy chain like a side link. This allows the chain to move right up to the bracket. Each chain requires one male and one female bracket. M8 screws are used to secure the brackets in place. Press-in metal metal bushes with either a through-hole (-FB) or a threaded hole (-FG) ensure the permanent, high-strength transmission of even extreme forces onto the energy chain.

Type	Order No.	Material	Version	Inside width								Outside width of KA 0 mm
				A mm	E mm	F mm	F1 mm	G mm	G1 mm	H mm	H0 mm	
KA 52.4-FB Female end	0524000050	Plastic	with bush	45.0 – 546.0	A+16.0	20.0	30.0	85.0	125.0	9.0	A+34.0	
KA 52.4-FB Female end, pendular	0524000052	Plastic	with bush	45.0 – 546.0	A+16.0	20.0	30.0	85.0	125.0	9.0	A+34.0	
KA 52.4-FB Male end	0524000051	Plastic	with bush	45.0 – 546.0	A+16.0	20.0	30.0	85.0	125.0	9.0	A+34.0	
KA 52.4-FG Female end	0524000053	Plastic	with thread	45.0 – 546.0	A+16.0	20.0	30.0	85.0	125.0	M8	A+34.0	
KA 52.4-FG Female end, pendular	0524000055	Plastic	with thread	45.0 – 546.0	A+16.0	20.0	30.0	85.0	125.0	M8	A+34.0	
KA 52.4-FG Male end	0524000054	Plastic	with thread	45.0 – 546.0	A+16.0	20.0	30.0	85.0	125.0	M8	A+34.0	

**MP 52.4 SLIDING BLOCK**

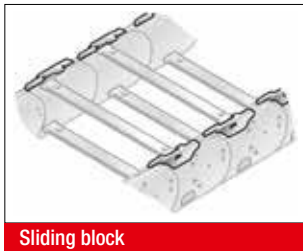

Sliding block

In the case of energy chains, sliding blocks are used in a horizontally sliding installation mode (the tight side of the chain slides on the slack side). The sliding blocks are set onto the side links on the interior bend instead of the usual crossbar interlocks; (no tools needed). This forces the chain to slide on the sliding blocks instead on the side links of the chain. Depending on the application, the service life of the energy chain may be extended five-fold, by using slide blocks. Information about the minimum bending radius of the energy chain at the sliding block insert is listed in the following table.

Type	Order No.	Installation site	Min. radius mm	Sliding block height mm
GS 52.4.1 right	052490400302	For right side link	150.0	4.0
GS 52.4.2 left	052490400300	For left side link	150.0	4.0

**GLP 5 (52.4) GLIDING PLATE**

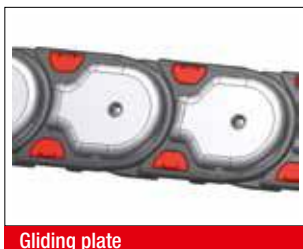

Gliding plate

The gliding plates are mounted in a horizontal position, with the chain laying on its side, to minimize friction wear to the sides. They are mounted to the side links using a special screw. The wear limit is 2.5 mm. We recommend replacing the energy chain when this limit has been reached. Depending on the application, the service life of the energy chain may be extended two-fold, by using gliding plates. The energy chain must be placed on its side before opening.

Type	Order No.	Installation site	For radius mm	Gliding plate height mm
SG 52.4 RK125.1 right with GLP5, mounted	052400012566	Right chain link including gliding plate	125.0	7.0
SG 52.4 RK125.2 left with GLP5, mounted	052400012564	Left chain link including gliding plate	125.0	7.0
SG 52.4 RK135.1 right with GLP5, mounted	052400013566	Right chain link including gliding plate	135.0	7.0
SG 52.4 RK135.2 left with GLP5, mounted	052400013564	Left chain link including gliding plate	135.0	7.0
SG 52.4 RK150.1 right with GLP5, mounted	052400015066	Right chain link including gliding plate	150.0	7.0
SG 52.4 RK150.2 left with GLP5, mounted	052400015064	Left chain link including gliding plate	150.0	7.0
SG 52.4 RK175.1 right with GLP5, mounted	052400017566	Right chain link including gliding plate	175.0	7.0
SG 52.4 RK175.2 left with GLP5, mounted	052400017564	Left chain link including gliding plate	175.0	7.0
SG 52.4 RK200.1 right with GLP5, mounted	052400020066	Right chain link including gliding plate	200.0	7.0
SG 52.4 RK200.2 left with GLP5, mounted	052400020064	Left chain link including gliding plate	200.0	7.0
SG 52.4 RK250.1 right with GLP5, mounted	052400025066	Right chain link including gliding plate	250.0	7.0
SG 52.4 RK250.2 left with GLP5, mounted	052400025064	Left chain link including gliding plate	250.0	7.0
SG 52.4 RK300.1 right with GLP5, mounted	052400030066	Right chain link including gliding plate	300.0	7.0
SG 52.4 RK300.2 left with GLP5, mounted	052400030064	Left chain link including gliding plate	300.0	7.0
SG 52.4-D RK125.1 right with GLP5, mounted	052400012596	Right chain link including gliding plate	125.0	7.0
SG 52.4-D RK125.2 left with GLP5, mounted	052400012594	Left chain link including gliding plate	125.0	7.0
SG 52.4-D RK135.1 right with GLP5, mounted	052400013596	Right chain link including gliding plate	135.0	7.0
SG 52.4-D RK135.2 left with GLP5, mounted	052400013594	Left chain link including gliding plate	135.0	7.0
SG 52.4-D RK150.1 right with GLP5, mounted	052400015096	Right chain link including gliding plate	150.0	7.0
SG 52.4-D RK150.2 left with GLP5, mounted	052400015094	Left chain link including gliding plate	150.0	7.0
SG 52.4-D RK175.1 right with GLP5, mounted	052400017596	Right chain link including gliding plate	175.0	7.0
SG 52.4-D RK175.2 left with GLP5, mounted	052400017594	Left chain link including gliding plate	175.0	7.0
SG 52.4-D RK200.1 right with GLP5, mounted	052400020096	Right chain link including gliding plate	200.0	7.0
SG 52.4-D RK200.2 left with GLP5, mounted	052400020094	Left chain link including gliding plate	200.0	7.0
SG 52.4-D RK250.1 right with GLP5, mounted	052400025096	Right chain link including gliding plate	250.0	7.0
SG 52.4-D RK250.2 left with GLP5, mounted	052400025094	Left chain link including gliding plate	250.0	7.0
SG 52.4-D RK300.1 right with GLP5, mounted	052400030096	Right chain link including gliding plate	300.0	7.0
SG 52.4-D RK300.2 left with GLP5, mounted	052400030094	Left chain link including gliding plate	300.0	7.0

**TR 52 SEPARATOR**

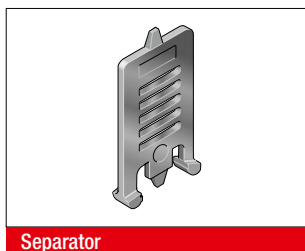
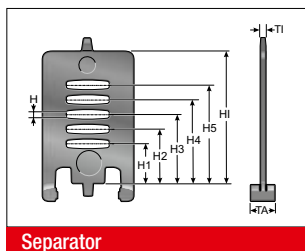

We recommend that separators be used if multiple round cables or conduits with differing diameters are to be installed. The closed separator is used when no shelves are used. This is the recommended design for travel paths of 30 metres or greater.

Type	Order No.	Description	Version	TI mm	TA mm	H mm	H1 mm	H2 mm	H3 mm	H4 mm	H5 mm	Hl mm
TR 52	052000009200	TR 52 Separator	lockable	3.5	10.0	4.2	16.3	22.3	28.2	33.8	39.8	52.0

**TR 52.1 SEPARATOR**

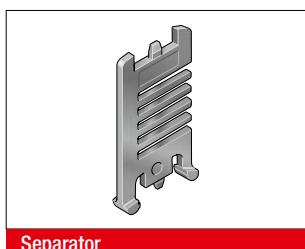
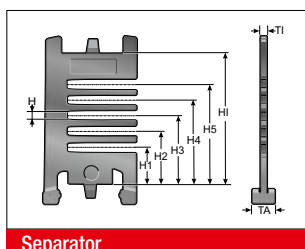

We recommend that separators be used if multiple round cables or conduits with differing diameters are to be installed.

Type	Order No.	Description	Version	TI mm	TA mm	H mm	H1 mm	H2 mm	H3 mm	H4 mm	H5 mm	Hl mm
TR 52.1	052100009200	TR 52.1 Separator	lockable	3.5	8.0	4.0	15.6	22.0	28.2	34.6	41.0	52.0

**TR 52-V SEPARATOR**

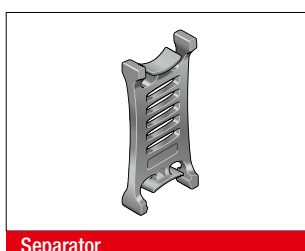
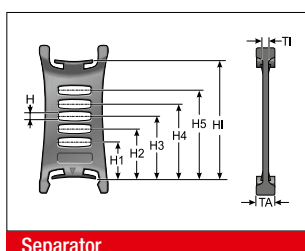

We recommend that separators be used if multiple round cables or conduits with differing diameters are to be installed.

Type	Order No.	Description	Version	TI mm	TA mm	H mm	H1 mm	H2 mm	H3 mm	H4 mm	H5 mm	Hl mm
TR 52-V	052000009300	TR 52-V Separator	moveable	3.5	13.0	4.0	16.3	22.3	28.2	33.8	39.8	52.0

**RTT 52 SHELF SUPPORT, DIVISIBLE**

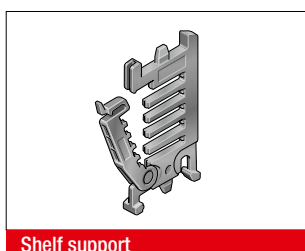
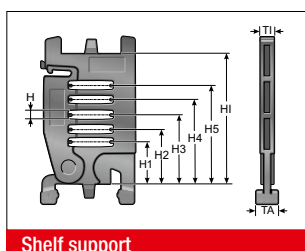

In connection with two separable shelf supports (RTT) with at least one end-to-end shelf (RB) the shelf becomes an easy to fill shelving system. The additional levels prevent cables from criss-crossing and minimise the friction between them.

Type	Order No.	Description	Version	TI mm	TA mm	H mm	H1 mm	H2 mm	H3 mm	H4 mm	H5 mm	Hl mm
RTT 52	100090522000	Shelf support, divisible	lockable	7.0	8.0	4.0	15.6	22.0	28.2	34.6	41.0	52.0

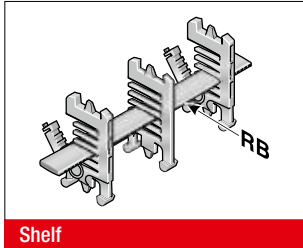
**RB-5 SHELF**

In connection with at least two separable shelf supports (RTT), the shelf becomes a shelving system. The additional levels prevent cables from criss-crossing and minimise the friction between them.

Type	Order No.	Description	Width mm	Inside width mm
RB 028-5	10000002800	Shelf	28.0	45.0
RB 034-5	1000003405	Shelf	33.6	45.0
RB 039-5	1000003905	Shelf	39.2	45.0
RB 045-5	1000004505	Shelf	44.8	57.0
RB 050-5	1000005005	Shelf	50.4	57.0
RB 056-5	10000005601	Shelf	56.0	62.0
RB 062-5	1000006205	Shelf	61.6	62.0
RB 067-5	1000006705	Shelf	67.2	84.0
RB 073-5	1000007305	Shelf	72.8	84.0
RB 078-5	1000007805	Shelf	78.4	84.0
RB 084-5	10000008400	Shelf	84.0	84.0
RB 090-5	1000009005	Shelf	89.6	96.0
RB 095-5	1000009505	Shelf	95.2	96.0
RB 101-5	1000010105	Shelf	100.8	107.0
RB 106-5	1000010605	Shelf	106.4	107.0
RB 112-5	100000011200	Shelf	112.0	121.0
RB 118-5	1000011805	Shelf	117.6	121.0
RB 123-5	1000012305	Shelf	123.2	133.0
RB 129-5	1000012905	Shelf	128.8	133.0
RB 134-5	1000013405	Shelf	134.4	144.0
RB 140-5	100000014000	Shelf	140.0	144.0
RB 146-5	1000014605	Shelf	145.6	158.0
RB 151-5	1000015105	Shelf	151.2	158.0
RB 157-5	1000015705	Shelf	156.8	164.0
RB 162-5	1000016205	Shelf	162.4	164.0
RB 168-5	100000016800	Shelf	168.0	182.0
RB 174-5	1000017405	Shelf	173.6	182.0
RB 179-5	1000017905	Shelf	179.2	196.0
RB 185-5	1000018505	Shelf	184.8	196.0
RB 190-5	1000019005	Shelf	190.4	196.0
RB 196-5	100000019600	Shelf	196.0	196.0
RB 291-5	100000029100	Shelf	291.2	346.0

### RSV 52 CROSSBAR CONNECTOR



For crossbars wider than 246 mm, we recommend the use of crossbar connectors. These prevent deformation to the crossbar under large amounts of additional weight of the chain assembly.

Type	Order No.	Description	TI mm
RSV 52	052000009600	Crossbar connector	7.5
RSV 52 Alu	052000009800	Crossbar connector for aluminium crossbars	7.5

### RE 52 H-SHAPED SHELF UNIT

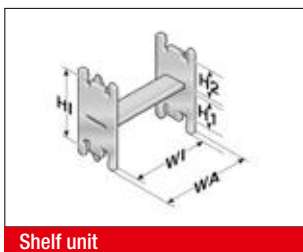

One-piece shelving system, the shelf cannot be varied in height.

Type	Order No.	Description	WA mm	WI mm	H1 mm	H2 mm	H3 mm
RE 36/17	100000361714	H-shaped shelf unit	42.5	36.5	31.0	17.4	52.0
RE 59/24	100000592414	H-shaped shelf unit	65.0	59.0	24.2	24.2	52.0
RE 81/12	100000811214	H-shaped shelf unit	87.5	81.5	36.0	12.4	52.0

### BS-5 BRACKET BAR



Large-diameter conduits are routed securely by using a bracket bar (BS). This bar is installed on the crossbars or the covers of the energy chain.

The bracket bar can be installed on both the inside and outside bend.

The bracket bar support (BSH) is used to attach the bars to PowerLine series crossbars. Two bracket bar supports are required for each bar.

Type	Order No.	Description	Conduit diameter max. mm	Installation height mm	Inner chain width min. mm
BS 120-5	052412000000	Bracket bar	115.0	140.0	164.0
BS 153-5	052415300000	Bracket bar	148.0	170.0	208.0
BS 187-5	052418700000	Bracket bar	182.0	205.0	233.0
BSH-5	052400000000	Bracket bar support			
Assembly set	052400000001	Assembly set			



### D4 CHAIN BRACKET COVER

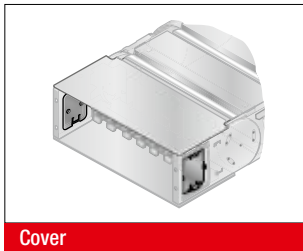

Self-locking covers close the side mounting window on the flexible chain bracket (KA-FB/FG).

Type	Order No.
D4 Cover	0413888002

### RS-ZL-5 CROSSBAR STRAIN RELIEF PLATE

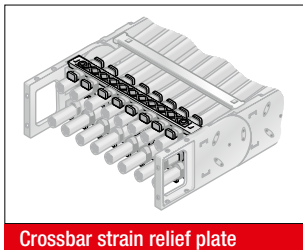

Fixed integrated frame bridge strain relief plates in the chain brackets. Tailored to all crossbar widths up to 246 mm. May be assembled on the inside and outside bends at both chain endings.

Type	Order No.	Description	Inside width mm
RS-ZL 045-5	052004500010	Crossbar strain relief plate	45.0
RS-ZL 057-5	052005700010	Crossbar strain relief plate	57.0
RS-ZL 062-5	052006200010	Crossbar strain relief plate	62.0
RS-ZL 071-5	052007100010	Crossbar strain relief plate	71.0
RS-ZL 084-5	052008400010	Crossbar strain relief plate	84.0
RS-ZL 093-5	052009300010	Crossbar strain relief plate	93.0
RS-ZL 096-5	052009600010	Crossbar strain relief plate	96.0
RS-ZL 104-5	052010400010	Crossbar strain relief plate	104.0
RS-ZL 107-5	052010700010	Crossbar strain relief plate	107.0
RS-ZL 121-5	052012100010	Crossbar strain relief plate	121.0
RS-ZL 133-5	052013300010	Crossbar strain relief plate	133.0
RS-ZL 144-5	052014400010	Crossbar strain relief plate	144.0
RS-ZL 146-5	052014600010	Crossbar strain relief plate	146.0
RS-ZL 158-5	052015800010	Crossbar strain relief plate	158.0
RS-ZL 164-5	052016400010	Crossbar strain relief plate	164.0
RS-ZL 171-5	052017100010	Crossbar strain relief plate	171.0
RS-ZL 182-5	052018200010	Crossbar strain relief plate	182.0
RS-ZL 196-5	052019600010	Crossbar strain relief plate	196.0
RS-ZL 208-5	052020800010	Crossbar strain relief plate	208.0
RS-ZL 220-5	052022000010	Crossbar strain relief plate	220.0
RS-ZL 233-5	052023300010	Crossbar strain relief plate	233.0
RS-ZL 246-5	052024600010	Crossbar strain relief plate	246.0

**STRAIN RELIEF WITH STEEL FIX**

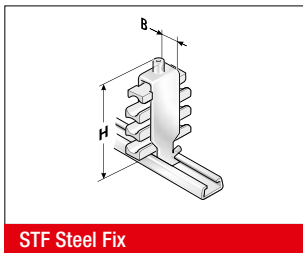

STF Steel Fix

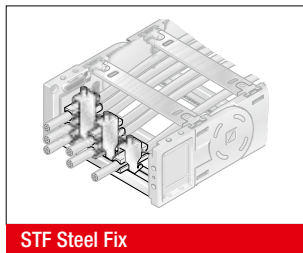

STF Steel Fix

C-rails (galvanised) for permanent integration, for accommodating the Steel Fix bow clamps in the chain brackets. The bow clamps can take up to 3 cables and are suitable for C-rails with a groove width of 11 mm. Due to the design of the trough elements, a cable preserving cable guidance is ensured. May be assembled on the inside and outside bends at both chain endings. The overall height stated is a guide only. The actual height is, amongst other things, dependent on the diameter and the quality of the cable. A safety distance of 10 mm at the fixed point above the strain relief must be kept during gliding applications.

Type	Order No.	Description	Seats qty.	Cable Ø mm	Width mm	Total height (H) mm
<b>Single clamp (for one cable)</b>						
STF 12-1 Steel Fix	81661801	Hooped clamp	1	6.0 – 12.0	16.0	55.0
STF 14-1 Steel Fix	81661802	Hooped clamp	1	12.0 – 14.0	18.0	52.0
STF 16-1 Steel Fix	81661803	Hooped clamp	1	14.0 – 16.0	20.0	54.0
STF 18-1 Steel Fix	81661804	Hooped clamp	1	16.0 – 18.0	22.0	56.0
STF 20-1 Steel Fix	81661805	Hooped clamp	1	18.0 – 20.0	24.0	59.0
STF 22-1 Steel Fix	81661806	Hooped clamp	1	20.0 – 22.0	26.0	61.0
STF 26-1 Steel Fix	81661807	Hooped clamp	1	22.0 – 26.0	30.0	70.0
STF 30-1 Steel Fix	81661808	Hooped clamp	1	26.0 – 30.0	34.0	74.0
STF 34-1 Steel Fix	81661809	Hooped clamp	1	30.0 – 34.0	38.0	78.0
STF 38-1 Steel Fix	81661810	Hooped clamp	1	34.0 – 38.0	42.0	82.0
STF 42-1 Steel Fix	81661811	Hooped clamp	1	38.0 – 42.0	46.0	91.0
<b>Double clamp (for two cables)</b>						
STF 12-2 Steel Fix	81661821	Hooped clamp	2	6.0 – 12.0	16.0	73.0
STF 14-2 Steel Fix	81661822	Hooped clamp	2	12.0 – 14.0	18.0	74.0
STF 16-2 Steel Fix	81661823	Hooped clamp	2	14.0 – 16.0	20.0	82.0
STF 18-2 Steel Fix	81661824	Hooped clamp	2	16.0 – 18.0	22.0	86.0
STF 20-2 Steel Fix	81661825	Hooped clamp	2	18.0 – 20.0	24.0	91.0
STF 22-2 Steel Fix	81661826	Hooped clamp	2	20.0 – 22.0	26.0	95.0
STF 26-2 Steel Fix	81661827	Hooped clamp	2	22.0 – 26.0	30.0	108.0
STF 30-2 Steel Fix	81661828	Hooped clamp	2	26.0 – 30.0	34.0	121.0
STF 34-2 Steel Fix	81661829	Hooped clamp	2	30.0 – 34.0	38.0	129.0
<b>Triple clamp (for three cables)</b>						
STF 12-3 Steel Fix	81661841	Hooped clamp	3	6.0 – 12.0	16.0	98.0
STF 14-3 Steel Fix	81661842	Hooped clamp	3	12.0 – 14.0	18.0	98.0
STF 16-3 Steel Fix	81661843	Hooped clamp	3	14.0 – 16.0	20.0	105.0
STF 18-3 Steel Fix	81661844	Hooped clamp	3	16.0 – 18.0	22.0	111.0
STF 20-3 Steel Fix	81661845	Hooped clamp	3	18.0 – 20.0	24.0	118.0
STF 22-3 Steel Fix	81661846	Hooped clamp	3	20.0 – 22.0	26.0	130.0

**GUIDE CHANNEL VAW (ALUMINIUM / STAINLESS STEEL)**



VAW steel galvanised / stainless steel



VAW aluminium

A range of variable guide channel systems, constructed from aluminium or stainless steel sections, are available for this energy chain.

The variable guide channel ensures that the energy chain is supported and guided securely.

**MP 52/62/72 LOCK BUTTON**

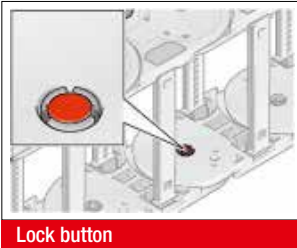

Lock button

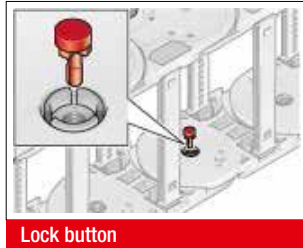

Lock button

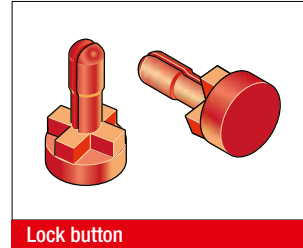

Lock button

To increase the side stability, we recommend the use of lock buttons during strong lateral acceleration or when installed

“laying on the side (turned 90°) without support”.

Type	Order No.
MP52/62/72 lock button	0520000080

**LOWERED FIXING POINT MP 52.4**

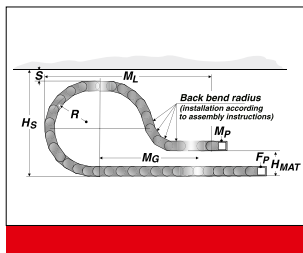
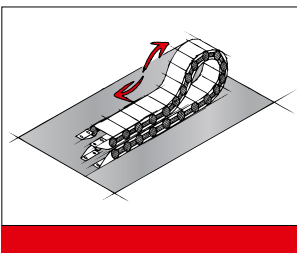

It is sometimes necessary to lower the height of the moving attachment point.

In such cases, modifications to the chain layout should be noted (e.g. extension of chain).

Please contact our application engineers.

Radius R mm	Height of moving end bracket (H <sub>MA</sub> ) mm	Safety margin (S) mm	Installation height incl. safety (H <sub>S</sub> ) mm	Projection (M <sub>L</sub> ) mm	Additional links qty.	of which additional back chain links qty.
175.0	180.0	50.0	475.0	620.0	6	3
200.0	210.0	50.0	525.0	830.0	10	3
250.0	250.0	50.0	625.0	990.0	13	3
300.0	300.0	50.0	725.0	900.0	14	3

**MP 52.4 REARWARD RADII**

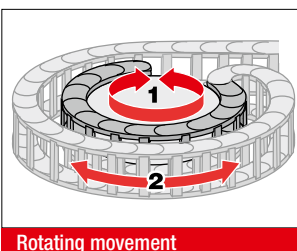

Rotating movement

Side links with rearward radius allow movements in both directions. This is intended for rotating movements and lowered chain brackets. Note: This type of chain has different chain links for the left or right side! Rotation movements are only possible with open variants.

Type	Order No.	Radius mm	Rearward radius mm
SR 52.4 (RÜ200/R200.1) right	052400020062	200.0	200.0
SR 52.4 (RÜ200/R200.2) left	052400020060	200.0	200.0

**ASSEMBLY INSTRUCTION FLEXIBLE CHAIN BRACKET FB/FG**

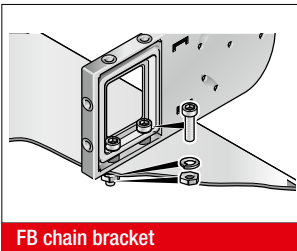

FB chain bracket

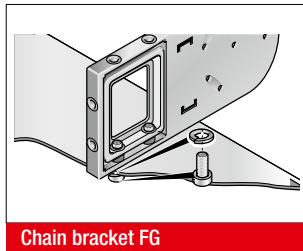

Chain bracket FG

Brass bushes guarantee long-lasting fastening without cold flow in the plastic.

**Version KA-FB:**

Integrated through-hole fastened down using screw and nut.

**Version KA-FG:**

Built-in threads allow for quick and easy on-site mounting, since a screw, including a retaining washer where necessary, is sufficient.

**ASSEMBLY**

**DISASSEMBLY**

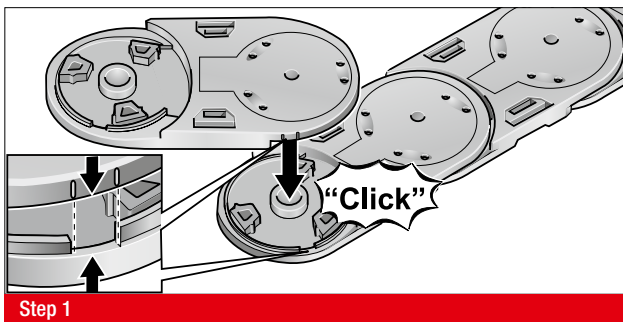

Step 1

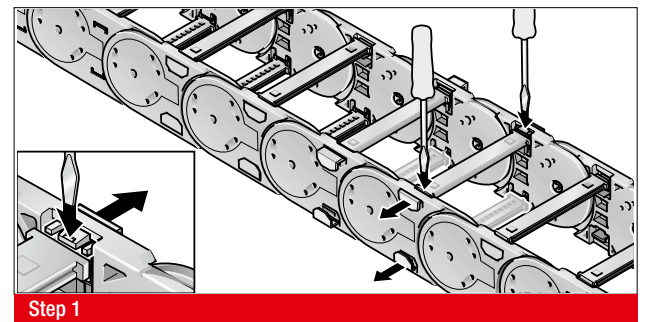

Step 1

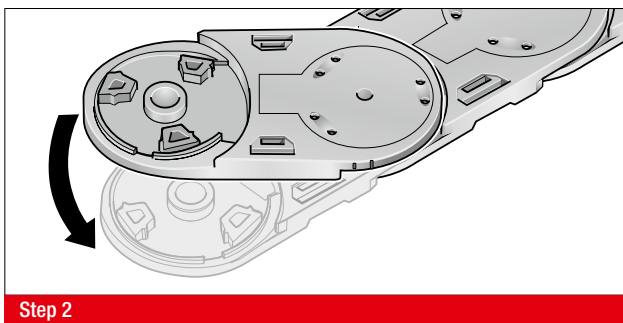

Step 2

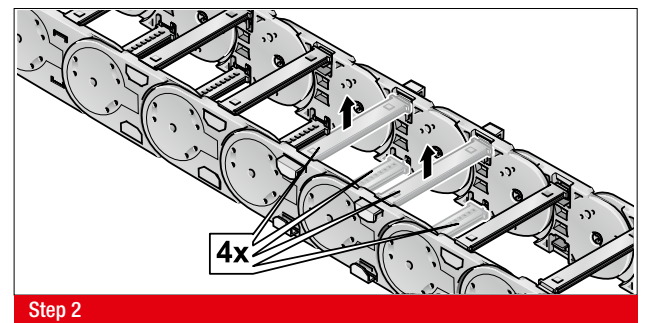

Step 2

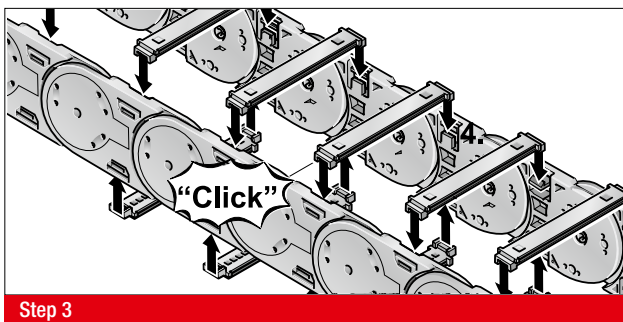

Step 3

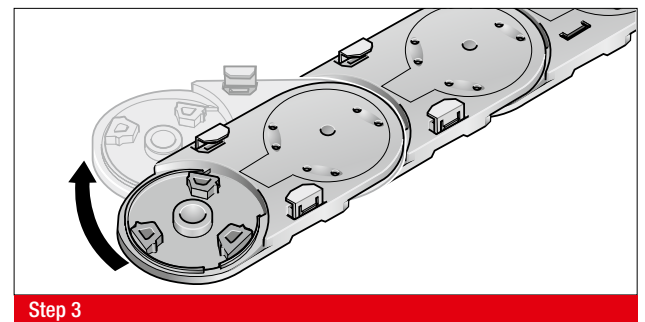

Step 3

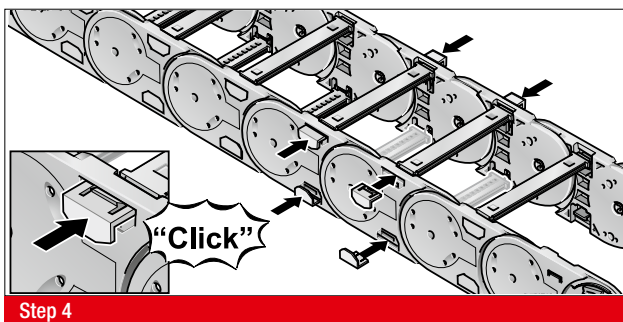

Step 4

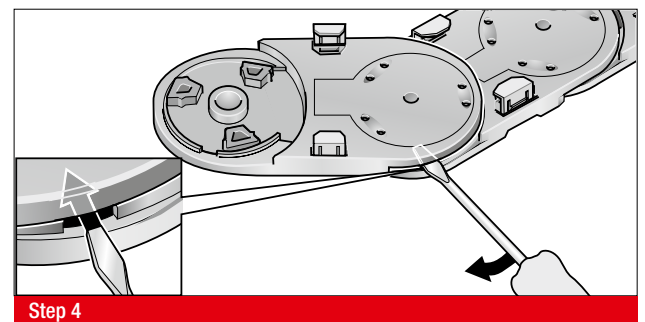

Step 4



## MP 52.6 OPEN



## MP 52.7 CLOSED



- FOR PARTICULARLY HIGH LOADING QUANTITIES
- FOR VERY LONG, SLIDING APPLICATIONS
- SLIDING BLOCKS FOR LONGER SERVICE LIFE
- CHAIN BRACKET FLEXIBLE

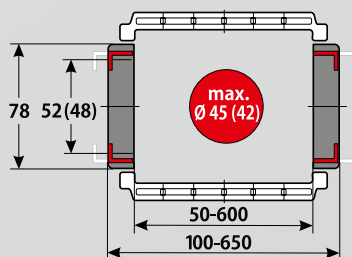

### TECHNICAL DATA

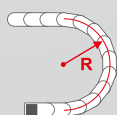

**Available radii**  
150.0 – 300.0 mm



**Available interior widths**  
With plastic crossbar  
50.0 – 600.0 mm  
With alu crossbar / with alu cover  
50.0 – 600.0 mm / 42.0 – 600.0 mm

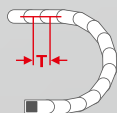

**Pitch**  
T = 91.0 mm





## TECHNICAL SPECIFICATIONS

Travel distance gliding $L_g$ max.	150.0 m
Travel distance vertical, hanging $L_{vh}$ max.	80.0 m
Travel distance vertical, upright $L_{vs}$ max.	6.0 m
Rotated 90°, unsupported $L_{90r}$ max.	1.5 m
Speed, gliding $V_g$ max.	6.0 m/s
Acceleration, gliding $a_g$ max.	10.0 m/s <sup>2</sup>

## MATERIAL PROPERTIES

Standard material	Polyamide (PA) black
Service temperature	-30.0 – 120.0 °C
Gliding friction factor	0.3
Static friction factor	0.45
Fire classification	UL 94 HB

Other material properties on request.

## SHELVING SYSTEM



Separator TR

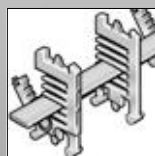

RS shelving system

## CHAIN BRACKET

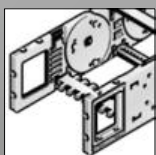

Chain bracket flexible



Crossbar connector RSV

## ACCESSORIES

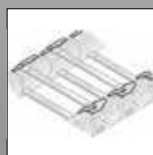

Sliding block

## GUIDE CHANNELS



VAW steel galvanised / stainless steel

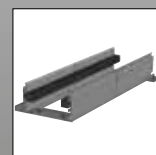

VAW aluminium

## STRAIN RELIEF

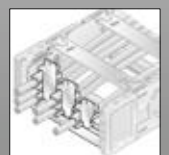

STF Steel Fix

**ORDERING KEY**

Dimensions in mm [US inch]

Type code	Variation	Inside width	Outside width	Inside width	Outside width	Radius	Crossbar variant	Material	Chain length
<b>0526 30</b>	MP 52.6 open Crossbar on outside bend Crossbar on inside bend Opens on inside and outside bend	<b>050</b> [1.97]	<b>100</b> [3.94]	<b>252</b> [9.92]	<b>302</b> [11.89]	<b>150</b> [5.91]	<b>5</b> Aluminium full-ridged without bias	<b>0</b> Polyamide standard (PA/black)	
		<b>071</b> [2.80]	<b>121</b> [4.76]	<b>258</b> [10.16]	<b>308</b> [12.13]				
<b>0527 44<sup>1)</sup></b>	MP 52.7 Closed Cover on outside bend Cover on inside bend Opens on inside and outside bend	<b>084</b> [3.31]	<b>134</b> [5.28]	<b>296</b> [11.65]	<b>346</b> [13.62]	<b>200</b> [7.87]	<b>7</b> Aluminium half-ridged without bias		
		<b>093</b> [3.66]	<b>143</b> [5.63]	<b>346</b> [13.62]	<b>396</b> [15.59]				
		<b>096</b> [3.78]	<b>146</b> [5.75]	<b>350</b> [13.78]	<b>400</b> [15.75]	<b>250</b> [9.84]			
		<b>104</b> [4.09]	<b>154</b> [6.06]	<b>358</b> [14.09]	<b>408</b> [16.06]				
		<b>107</b> [4.21]	<b>157</b> [6.18]	<b>371</b> [14.61]	<b>421</b> [16.57]	<b>300</b> [11.81]			
		<b>121</b> [4.76]	<b>171</b> [6.73]	<b>396</b> [15.59]	<b>446</b> [17.56]				
		<b>133</b> [5.24]	<b>183</b> [7.20]	<b>421</b> [16.57]	<b>471</b> [18.54]				
		<b>144</b> [5.67]	<b>194</b> [7.64]	<b>446</b> [17.56]	<b>496</b> [19.53]				
		<b>146</b> [5.75]	<b>196</b> [7.72]	<b>496</b> [19.53]	<b>546</b> [21.50]				
		<b>158</b> [6.22]	<b>208</b> [8.19]	<b>546</b> [21.50]	<b>596</b> [23.46]				
		<b>164</b> [6.46]	<b>214</b> [8.43]	<b>600</b> [23.62]	<b>650</b> [25.59]				
		<b>171</b> [6.73]	<b>221</b> [8.70]						
		<b>182</b> [7.17]	<b>232</b> [9.13]						
		<b>196</b> [7.72]	<b>246</b> [9.69]						
		<b>208</b> [8.19]	<b>258</b> [10.16]						
		<b>220</b> [8.66]	<b>270</b> [10.63]						
		<b>233</b> [9.17]	<b>283</b> [11.14]						
		<b>246</b> [9.69]	<b>296</b> [11.65]						



**ORDERING EXAMPLE: 0526 30 220 250 5 0 25000**

Crossbar on outside bend, crossbar on inside bend, can be opened from inside and outside bend  
 Inside width 220 mm, radius 250 mm  
 Aluminium crossbar, full-ridged without bias, material black-coloured polyamide  
 Chain length 25000 mm (275 links)

<sup>1)</sup> Reduced inner height, reduced max. cable diameter, see chain window drawing on previous page



**NOTE ON CONFIGURATION**

**Crossbars and cover from aluminium:**

This energy chain is suitable for aluminium frame bridges and covers only.

Aluminium crossbars can be supplied in 1 mm width sizes for inner widths from 50.0 mm – 600.0 mm .

Aluminium covers can be supplied in 1 mm width sizes for inner widths from 42.0 mm – 600.0 mm .

**Crossbar connector and strain relief:**

Once inside widths exceed 246 mm, we recommend the deployment of crossbar connectors (RSV).

Crossbar connectors cannot be used in conjunction with covers made from aluminium.

Steel Fix bow clamps are used for strain relief. The C-rails needed for accommodating the Steel Fix bow clamps can be integrated into the chain brackets.

For detailed information, please consult the corresponding product documentation.

**DETERMINING THE CHAIN LENGTH**

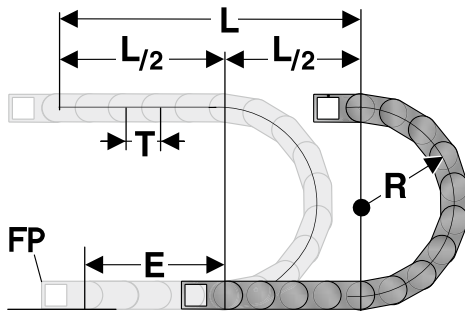

The fixed point of the energy chain should be connected in the middle of the travel distance.

This arrangement gives the shortest connection between the fixed point (FP) and the moving consumer and thus the most efficient chain length.

Chain length calculation =  $L/2 + \pi * R + E$   
 $\approx 1 \text{ m chain} = 11 \text{ qty. x}91.0 \text{ mm.}$

- E = Distance between entry point and middle of travel distance
- L = Travel distance
- R = Radius
- P = Pitch 91.0 mm

**INSTALLATION DIMENSIONS**

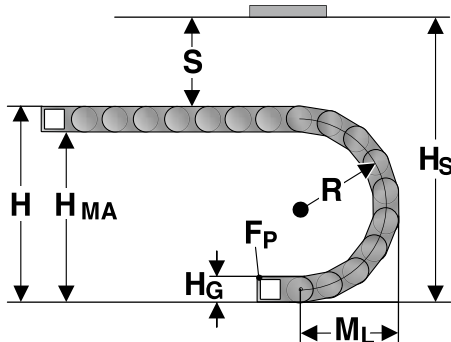

The moving end chain connection is to be screw fixed at height H<sub>MA</sub> for the respective radius.

For the installed dimension the “Installed height H<sub>s</sub>” value has to be taken into account.

Radius R	150	200	250	300
Outside height of chain link (H <sub>e</sub> )	78	78	78	78
Height of bend (H)	378	478	578	678
Height of moving end bracket (H <sub>MA</sub> )	300	400	500	600
Safety margin (S)	12	12	12	12
Installation height (H <sub>s</sub> )	390	490	590	690
Arc projection (M <sub>L</sub> )	280	330	380	430

**KA 52.6 CHAIN BRACKET FLEXIBLE**

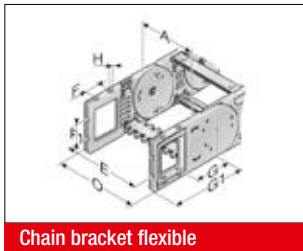

Chain bracket flexible

This chain bracket offers universal connection options (top, bottom and front) and is attached to the ends of the chain like a side link. This allows the chain to move right up to the bracket. Each chain requires one male and one female bracket. M8 screws are used to secure the brackets in place. Pressed-in metal bushes with a through-hole ensure the permanent, high-strength transmission of even extreme forces onto the energy chain.

Type	Order No.	Material	Version	Inside width							Outside width of KA 0 mm
				A mm	E mm	F mm	F1 mm	G mm	G1 mm	H0 mm	
KA 52.6-F Hole, completely	0526000050	Plastic	with bush	50.0 – 600.0	A+25.0	35.0	30.0	72.5	131.0	8.5	A+50.0
KA 52.6-F Male end, completely	0526000051	Plastic	with bush	50.0 – 600.0	A+25.0	35.0	30.0	72.5	131.0	8.5	A+50.0

**MP 52.6 SLIDING BLOCK**



In the case of energy chains, sliding blocks are used in a horizontally sliding installation mode (the tight side of the chain slides on the slack side). The sliding blocks are set onto the side links on the interior bend (no tools necessary). This forces the chain to slide on the sliding blocks instead on the side links of the chain. Depending on the application, the service life of the energy chain may be extended five-fold, by using slide blocks. Information about the minimum bending radius of the energy chain at the sliding block insert is listed in the following table.

Type	Order No.	Installation site	Min. radius mm	Sliding block height mm
GS 52.6.1 G	052690400306	For right side link	150.0	4.0
GS 52.6.2 G	052690400304	For left side link	150.0	4.0

**TR 52 SEPARATOR**

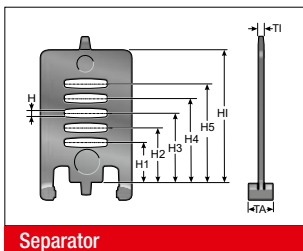

Separator

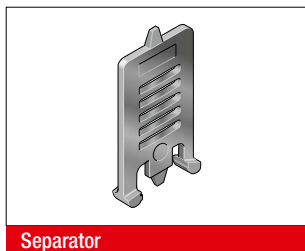

Separator

We recommend that separators be used if multiple round cables or conduits with differing diameters are to be installed. The closed separator is used when no shelves are used. This is the recommended design for travel paths of 30 metres or greater.

Type	Order No.	Description	Version	TI mm	TA mm	H mm	H1 mm	H2 mm	H3 mm	H4 mm	H5 mm	Hl mm
TR 52	052000009200	TR 52 Separator	lockable	3.5	10.0	4.2	16.3	22.3	28.2	33.8	39.8	52.0

**TR 52.1 SEPARATOR**

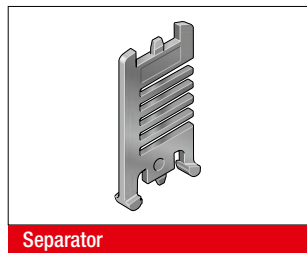
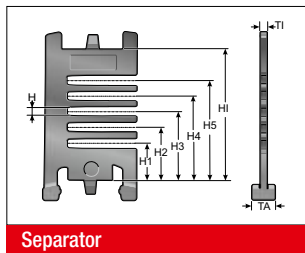

We recommend that separators be used if multiple round cables or conduits with differing diameters are to be installed.

Type	Order No.	Description	Version	TI mm	TA mm	H mm	H1 mm	H2 mm	H3 mm	H4 mm	H5 mm	H1 mm
TR 52.1	052100009200	TR 52.1 Separator	lockable	3.5	8.0	4.0	15.6	22.0	28.2	34.6	41.0	52.0

**TR 52-V SEPARATOR**

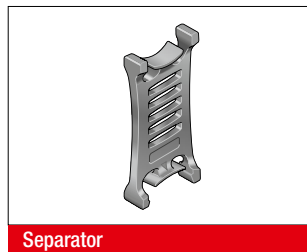
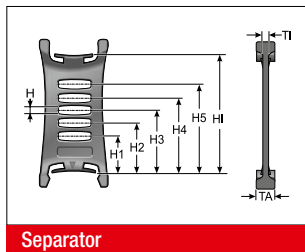

We recommend that separators be used if multiple round cables or conduits with differing diameters are to be installed.

Type	Order No.	Description	Version	TI mm	TA mm	H mm	H1 mm	H2 mm	H3 mm	H4 mm	H5 mm	H1 mm
TR 52-V	052000009300	TR 52-V Separator	moveable	3.5	13.0	4.0	16.3	22.3	28.2	33.8	39.8	52.0

**RTT 52 SHELF SUPPORT, DIVISIBLE**

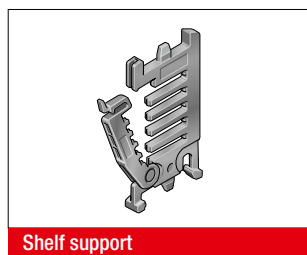
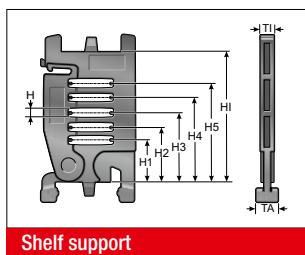

In connection with two separable shelf supports (RTT) with at least one end-to-end shelf (RB) the shelf becomes an easy to fill shelving system. The additional levels prevent cables from criss-crossing and minimise the friction between them.

Type	Order No.	Description	Version	TI mm	TA mm	H mm	H1 mm	H2 mm	H3 mm	H4 mm	H5 mm	H1 mm
RTT 52	100090522000	Shelf support, divisible	lockable	7.0	8.0	4.0	15.6	22.0	28.2	34.6	41.0	52.0

**RSV 52 CROSSBAR CONNECTOR**



For crossbars wider than 246 mm, we recommend the use of crossbar connectors. These prevent deformation to the crossbar under large amounts of additional weight of the chain assembly.

Type	Order No.	Description	TI mm
RSV 52 Alu	052000009800	Crossbar connector for aluminium crossbars	7.5

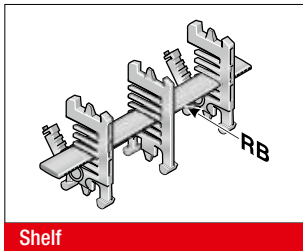
**RB-5 SHELF**

In connection with at least two separable shelf supports (RTT), the shelf becomes a shelving system. The additional levels prevent cables from criss-crossing and minimise the friction between them.

Type	Order No.	Description	Width mm	Inside width mm
RB 028-5	10000002800	Shelf	28.0	45.0
RB 034-5	1000003405	Shelf	33.6	45.0
RB 039-5	1000003905	Shelf	39.2	45.0
RB 045-5	1000004505	Shelf	44.8	57.0
RB 050-5	1000005005	Shelf	50.4	57.0
RB 056-5	10000005601	Shelf	56.0	62.0
RB 062-5	1000006205	Shelf	61.6	62.0
RB 067-5	1000006705	Shelf	67.2	84.0
RB 073-5	1000007305	Shelf	72.8	84.0
RB 078-5	1000007805	Shelf	78.4	84.0
RB 084-5	10000008400	Shelf	84.0	84.0
RB 090-5	1000009005	Shelf	89.6	96.0
RB 095-5	1000009505	Shelf	95.2	96.0
RB 101-5	1000010105	Shelf	100.8	107.0
RB 106-5	1000010605	Shelf	106.4	107.0
RB 112-5	100000011200	Shelf	112.0	121.0
RB 118-5	1000011805	Shelf	117.6	121.0
RB 123-5	1000012305	Shelf	123.2	133.0
RB 129-5	1000012905	Shelf	128.8	133.0
RB 134-5	1000013405	Shelf	134.4	144.0
RB 140-5	100000014000	Shelf	140.0	144.0
RB 146-5	1000014605	Shelf	145.6	158.0
RB 151-5	1000015105	Shelf	151.2	158.0
RB 157-5	1000015705	Shelf	156.8	164.0
RB 162-5	1000016205	Shelf	162.4	164.0
RB 168-5	100000016800	Shelf	168.0	182.0
RB 174-5	1000017405	Shelf	173.6	182.0
RB 179-5	1000017905	Shelf	179.2	196.0
RB 185-5	1000018505	Shelf	184.8	196.0
RB 190-5	1000019005	Shelf	190.4	196.0
RB 196-5	100000019600	Shelf	196.0	196.0
RB 291-5	100000029100	Shelf	291.2	346.0

## STRAIN RELIEF WITH STEEL FIX

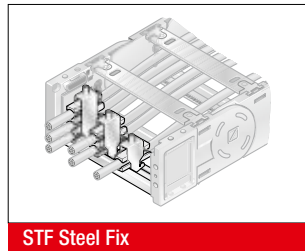
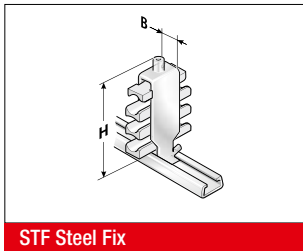

C-rails (galvanised) for permanent integration, for accommodating the Steel Fix bow clamps in the chain brackets. The bow clamps can take up to 3 cables and are suitable for C-rails with a groove width of 11 mm. Due to the design of the trough elements, a cable preserving cable guidance is ensured. May be assembled on the inside and outside bends at both chain endings. The overall height stated is a guide only. The actual height is, amongst other things, dependent on the diameter and the quality of the cable. A safety distance of 10 mm at the fixed point above the strain relief must be kept during gliding applications.

Type	Order No.	Description	Seats qty.	Cable Ø mm	Width mm	Total height (H) mm
<b>Single clamp (for one cable)</b>						
STF 12-1 Steel Fix	81661801	Hooped clamp	1	6.0 – 12.0	16.0	55.0
STF 14-1 Steel Fix	81661802	Hooped clamp	1	12.0 – 14.0	18.0	52.0
STF 16-1 Steel Fix	81661803	Hooped clamp	1	14.0 – 16.0	20.0	54.0
STF 18-1 Steel Fix	81661804	Hooped clamp	1	16.0 – 18.0	22.0	56.0
STF 20-1 Steel Fix	81661805	Hooped clamp	1	18.0 – 20.0	24.0	59.0
STF 22-1 Steel Fix	81661806	Hooped clamp	1	20.0 – 22.0	26.0	61.0
STF 26-1 Steel Fix	81661807	Hooped clamp	1	22.0 – 26.0	30.0	70.0
STF 30-1 Steel Fix	81661808	Hooped clamp	1	26.0 – 30.0	34.0	74.0
STF 34-1 Steel Fix	81661809	Hooped clamp	1	30.0 – 34.0	38.0	78.0
STF 38-1 Steel Fix	81661810	Hooped clamp	1	34.0 – 38.0	42.0	82.0
STF 42-1 Steel Fix	81661811	Hooped clamp	1	38.0 – 42.0	46.0	91.0
<b>Double clamp (for two cables)</b>						
STF 12-2 Steel Fix	81661821	Hooped clamp	2	6.0 – 12.0	16.0	73.0
STF 14-2 Steel Fix	81661822	Hooped clamp	2	12.0 – 14.0	18.0	74.0
STF 16-2 Steel Fix	81661823	Hooped clamp	2	14.0 – 16.0	20.0	82.0
STF 18-2 Steel Fix	81661824	Hooped clamp	2	16.0 – 18.0	22.0	86.0
STF 20-2 Steel Fix	81661825	Hooped clamp	2	18.0 – 20.0	24.0	91.0
STF 22-2 Steel Fix	81661826	Hooped clamp	2	20.0 – 22.0	26.0	95.0
STF 26-2 Steel Fix	81661827	Hooped clamp	2	22.0 – 26.0	30.0	108.0
STF 30-2 Steel Fix	81661828	Hooped clamp	2	26.0 – 30.0	34.0	121.0
STF 34-2 Steel Fix	81661829	Hooped clamp	2	30.0 – 34.0	38.0	129.0
<b>Triple clamp (for three cables)</b>						
STF 12-3 Steel Fix	81661841	Hooped clamp	3	6.0 – 12.0	16.0	98.0
STF 14-3 Steel Fix	81661842	Hooped clamp	3	12.0 – 14.0	18.0	98.0
STF 16-3 Steel Fix	81661843	Hooped clamp	3	14.0 – 16.0	20.0	105.0
STF 18-3 Steel Fix	81661844	Hooped clamp	3	16.0 – 18.0	22.0	111.0
STF 20-3 Steel Fix	81661845	Hooped clamp	3	18.0 – 20.0	24.0	118.0
STF 22-3 Steel Fix	81661846	Hooped clamp	3	20.0 – 22.0	26.0	130.0

**MP 52.6 LOWERED FIXING POINT**

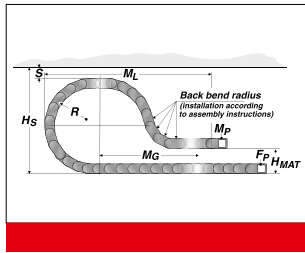
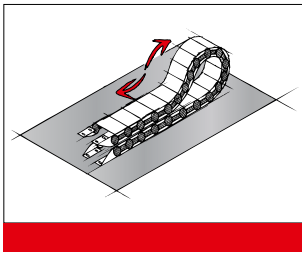

It is sometimes necessary to lower the height of the moving attachment point.

In such cases, modifications to the chain layout should be noted (e.g. extension of chain).

Please contact our application engineers.

Radius R mm	Height of moving end bracket (H <sub>MA</sub> ) mm	Safety margin (S) mm	Installation height incl. safety (H <sub>S</sub> ) mm	Projection (M <sub>L</sub> ) mm	Additional links qty.	of which additional back chain links qty.
200.0	210.0	50.0	528.0	830.0	10	3
250.0	250.0	50.0	628.0	990.0	13	3
300.0	300.0	50.0	728.0	900.0	14	3

**MP 52.6 REARWARD RADII**

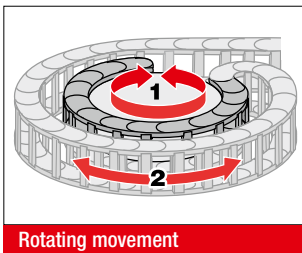

Rotating movement

Side links with rearward radius allow movements in both directions. This is intended for rotating movements and lowered chain brackets. Note: This type of chain has different chain links for the left or right side! Rotation movements are only possible with open variants.

Type	Order No.	Radius mm	Rearward radius mm
SR 52.6 RK250.2 (RÜ250/R250) left GS	052600025060	250.0	250.0
SR 52.6 RK250.1 (RÜ250/R250) right GS	052600025062	250.0	250.0

**GUIDE CHANNEL VAW (ALUMINIUM / STAINLESS STEEL)**



VAW steel galvanised / stainless steel



VAW aluminium

A range of variable guide channel systems, constructed from aluminium or stainless steel sections, are available for this energy chain. The variable guide channel ensures that the energy chain is supported and guided securely.

**ASSEMBLY INSTRUCTION FLEXIBLE CHAIN BRACKET FB/FG**

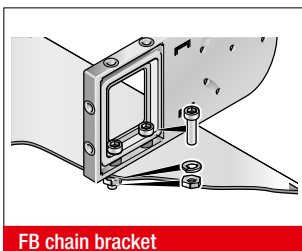

FB chain bracket

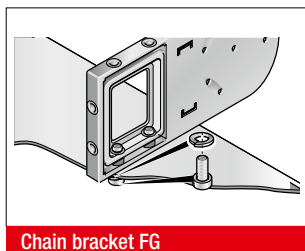

Chain bracket FG

Brass bushes guarantee long-lasting fastening without cold flow in the plastic.

**Version KA-FB:**  
Integrated through-hole fastened down using screw and nut.

**Version KA-FG:**  
Built-in threads allow for quick and easy on-site mounting, since a screw, including a retaining washer where necessary, is sufficient.

ASSEMBLY

DISASSEMBLY

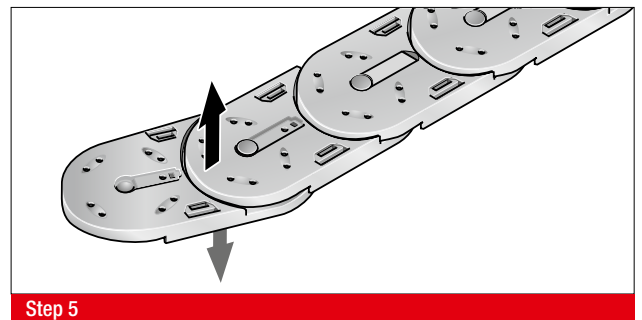
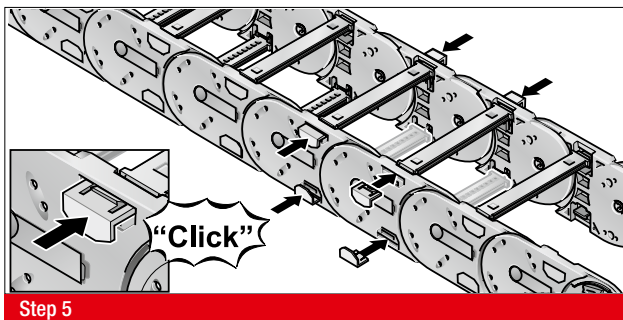
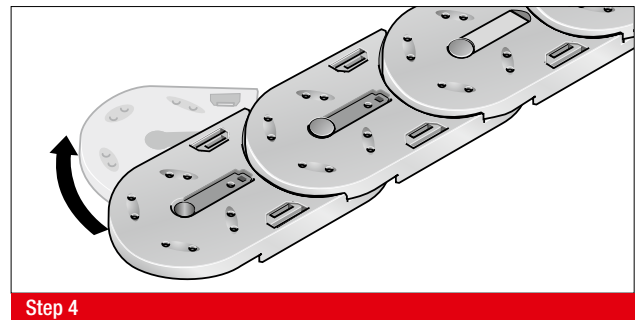
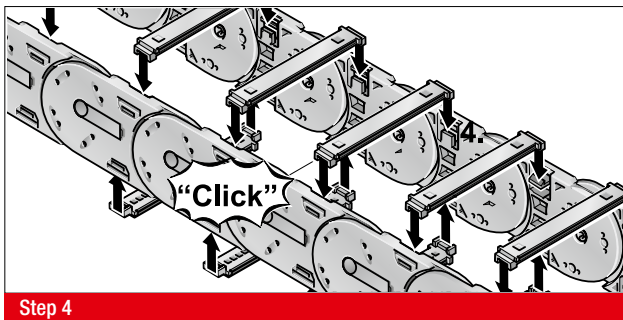
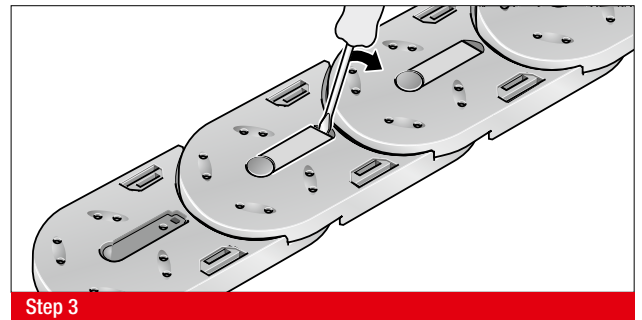
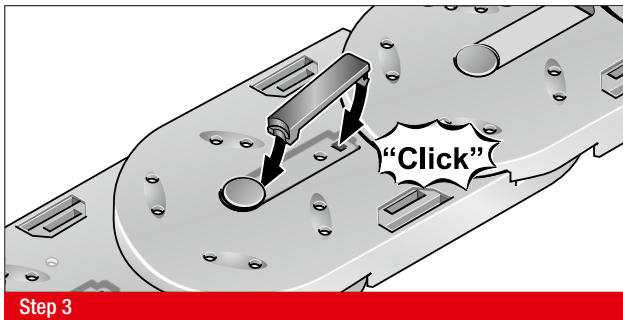
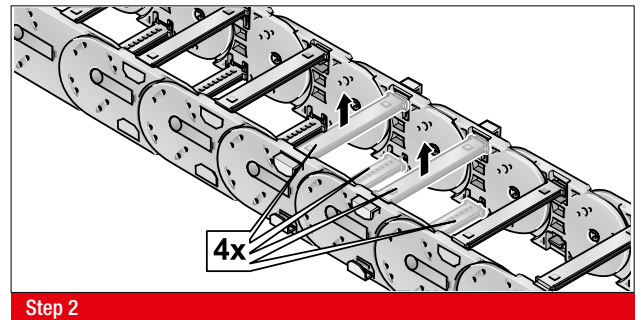
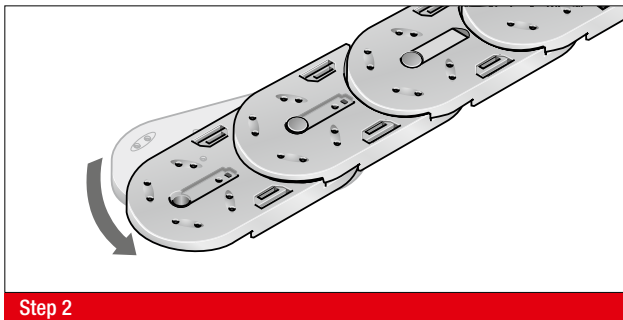
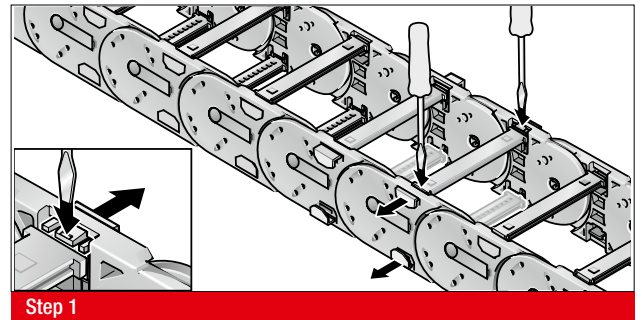
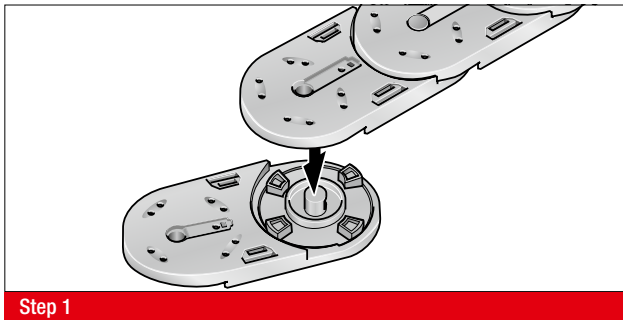

## MP 62.4 OPEN



- LOW-COST VARIANT
- SOFT-STOP SYSTEM
- CHAIN BRACKET FLEXIBLE
- BROAD INTERIOR LAYOUT
- PLASTIC OR ALUMINIUM VERSION

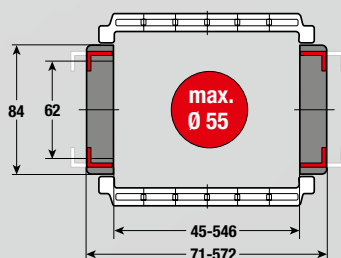

### TECHNICAL DATA

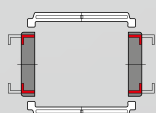

**Loading side**  
Inside and outside bend

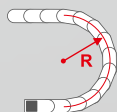

**Available radii**  
135.0 – 300.0

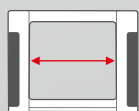

**Available interior widths**  
With plastic crossbar  
45.0 – 546.0  
With alu crossbar / with alu cover  
67.0 – 600.0 mm /

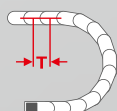

**Pitch**  
T = 91.0 mm



**Noise attenuator**  
Reduction of the noise emission by up to 10 dB(A) by the use of damping elements in the chain links.

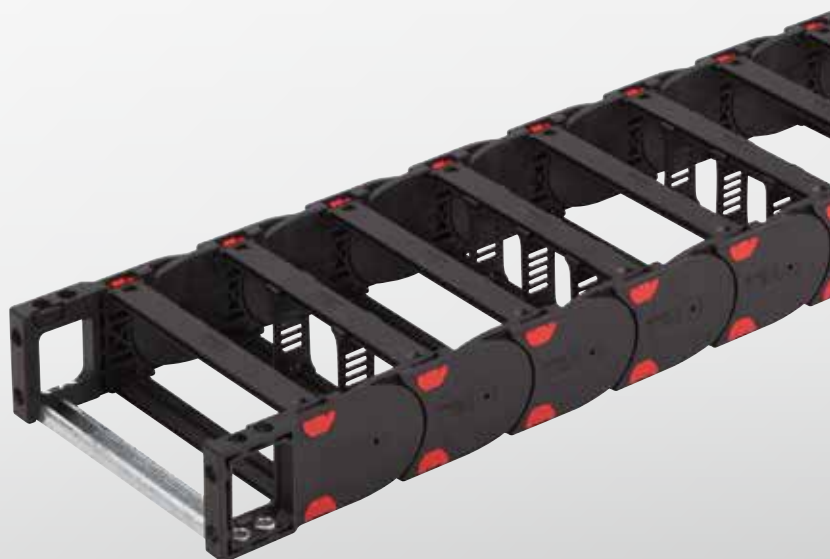





## TECHNICAL SPECIFICATIONS

Travel distance gliding $L_g$ max.	50.0 m
Travel distance self-supporting $L_s$ max.	see diagram on page 276
Travel distance vertical, hanging $L_{vh}$ max.	50.0 m
Travel distance vertical, upright $L_{vs}$ max.	4.0 m
Rotated 90°, unsupported $L_{90f}$ max.	1.0 m
Speed, gliding $V_g$ max.	5.0 m/s
Speed, self-supporting $V_f$ max.	20.0 m/s
Acceleration, gliding $a_g$ max.	25.0 m/s <sup>2</sup>
Acceleration, self-supporting $a_s$ max.	30.0 m/s <sup>2</sup>

Contact our engineering department to meet any higher requirements: [efk@murrplastik.de](mailto:efk@murrplastik.de)

## MATERIAL PROPERTIES

Standard material	Polyamide (PA) black
Service temperature	-30.0 – 120.0 °C
Gliding friction factor	0.3
Static friction factor	0.45
Fire classification	UL 94 HB

Other material properties on request.

## ACCESSORIES

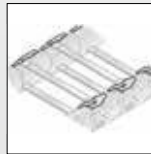

Sliding block

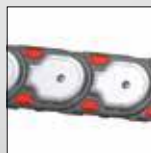

Gliding plate

## SHELVING SYSTEM



Separator TR



Bracket bar

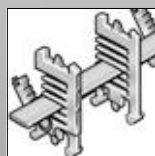

RS shelving system



Cover

## GUIDE CHANNELS



VAW steel galvanised / stainless steel

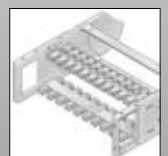

RS-ZL crossbar strain relief

## CHAIN BRACKET

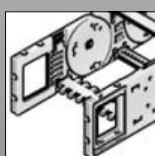

Chain bracket flexible



Crossbar connector RSV

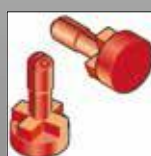

Lock button

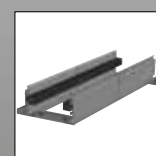

VAW aluminium



STF Steel Fix

**ORDERING KEY**

Dimensions in mm [US inch]

Type code	Variation	Inside width	Outside width	Inside width	Outside width	Radius	Crossbar variant	Material	Chain length
<b>0624 30</b>	Crossbar on outside bend Crossbar on inside bend Opens on inside and outside bend	<b>045<sup>1)</sup></b> [1.77]	<b>071</b> [2.80]	<b>233</b> [9.17]	<b>259</b> [10.20]	<b>135</b> [5.31]	<b>0</b> Plastic, full-ridged with bias	<b>2</b> Polyamide without attenuator (PA/black)	
		<b>057<sup>1)</sup></b> [2.24]	<b>083</b> [3.27]	<b>246</b> [9.69]	<b>272</b> [10.71]				
		<b>062<sup>1)</sup></b> [2.44]	<b>088</b> [3.46]	<b>252</b> [9.92]	<b>278</b> [10.94]	<b>150</b> [5.91]	<b>1</b> Plastic, full-ridged without bias	<b>3</b> Polyamide with attenuator (PA/black)	
		<b>071</b> [2.80]	<b>097</b> [3.82]	<b>258</b> [10.16]	<b>284</b> [11.18]				
		<b>084</b> [3.31]	<b>110</b> [4.33]	<b>296</b> [11.65]	<b>322</b> [12.68]	<b>175</b> [6.89]	<b>2</b> Plastic, half-ridged with bias	<b>9</b> Special version (on request)	
		<b>093</b> [3.66]	<b>119</b> [4.69]	<b>346</b> [13.62]	<b>372</b> [14.65]				
		<b>096</b> [3.78]	<b>122</b> [4.80]	<b>350</b> [13.78]	<b>376</b> [14.80]	<b>200</b> [7.87]	<b>3</b> Plastic, half-ridged without bias		
		<b>104</b> [4.09]	<b>130</b> [5.12]	<b>358</b> [14.09]	<b>384</b> [15.12]				
		<b>107</b> [4.21]	<b>133</b> [5.24]	<b>371</b> [14.61]	<b>397</b> [15.63]	<b>250</b> [9.84]	<b>4</b> Aluminium full-ridged with bias		
		<b>121</b> [4.76]	<b>147</b> [5.79]	<b>396</b> [15.59]	<b>422</b> [16.61]				
		<b>133</b> [5.24]	<b>159</b> [6.26]	<b>421</b> [16.57]	<b>447</b> [17.60]	<b>300</b> [11.81]	<b>5</b> Aluminium full-ridged without bias		
		<b>144</b> [5.67]	<b>170</b> [6.69]	<b>446</b> [17.56]	<b>472</b> [18.58]				
		<b>146</b> [5.75]	<b>172</b> [6.77]	<b>496</b> [19.53]	<b>522</b> [20.55]		<b>6</b> Aluminium half-ridged with bias		
		<b>158</b> [6.22]	<b>184</b> [7.24]	<b>546</b> [21.50]	<b>572</b> [22.52]				
		<b>164</b> [6.46]	<b>190</b> [7.48]				<b>7</b> Aluminium half-ridged without bias		
		<b>171</b> [6.73]	<b>197</b> [7.76]						
		<b>182</b> [7.17]	<b>208</b> [8.19]				<b>9</b> Special version (on request)		
		<b>196</b> [7.72]	<b>222</b> [8.74]						
		<b>208</b> [8.19]	<b>234</b> [9.21]						
		<b>220</b> [8.66]	<b>246</b> [9.69]						

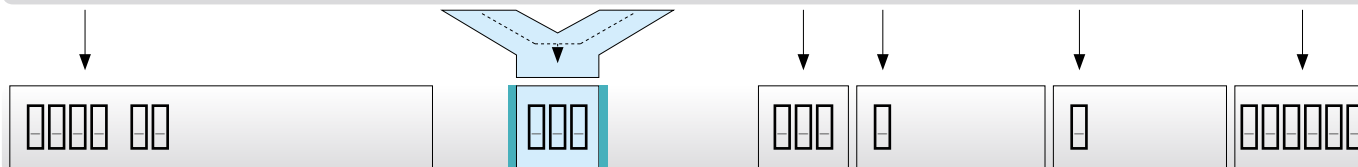

**ORDERING EXAMPLE: 0624 30 144 200 0 3 3000**

Crossbar on outside bend, crossbar on inside bend, can be opened from inside and outside bend  
 Inside width 144 mm, radius 200 mm  
 Plastic, full-ridged with bias, material polyamide with damper (PA/black)  
 Chain length 3000 mm (33 links)

<sup>1)</sup> for Variant 30 only

**NOTE ON CONFIGURATION**

**Aluminium crossbars:**

Aluminium crossbars can be supplied in 1 mm width sizes for inner widths from 67.0 mm – 600.0 mm.

**Crossbar strain relief plate:**

If crossbar strain relief plates (RS-ZL) are to be deployed in the chain brackets, take standard inside widths into account.

For detailed information, please consult the corresponding product documentation.

**SELF-SUPPORTING LENGTH**

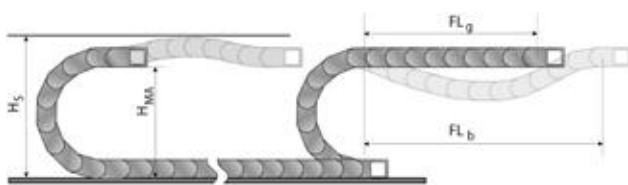

The self-supporting length is the distance between the chain bracket on the moving end and the start of the chain arch. The installation variant  $FL_g$  offers the lowest load and wear for the energy chain. The maximum travel parameters (speed and acceleration) can be applied for this variant.

- $H_s$  = Installation height plus safety
- $H_{MA}$  = Height of moving end connection
- $FL_g$  = Self-supporting length, upper run straight
- $FL_b$  = Self-supporting length, upper run bent

**LOAD DIAGRAM FOR SELF-SUPPORTING APPLICATIONS**

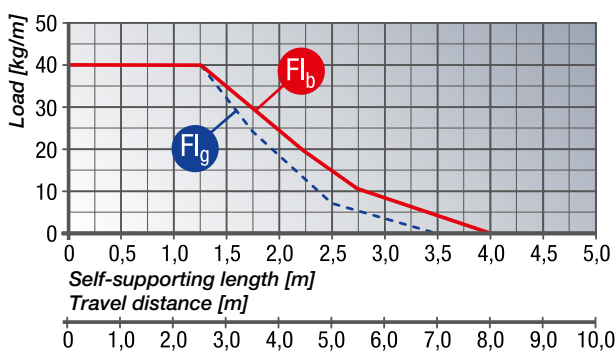

**$FL_g$  Self-supporting length, upper run straight**

In the  $FL_g$  range, the chain upper run still has a bias, is straight or has a maximum sag of 70.0 mm.

**$FL_b$  Self-supporting length, upper run bent**

In the  $FL_b$  range, the chain upper run has a sag of more than 70.0 mm, but this is still less than the maximum sag. Where the sag is greater than that permitted in the  $FL_b$  range, the application is critical and should be avoided. The self-supporting length can be optimised by using a support for the upper run or a more stable energy chain.

Closed cable drag chains (with covers) have a higher unit weight than open chains (with frame bridges). This higher weight must be taken into account when calculating the self-supporting length. To the weight of the cabling (cable load, in kg/m), you must add 1.5 kg/m, to account for the higher weight of closed-cover chains.

**DETERMINING THE CHAIN LENGTH**

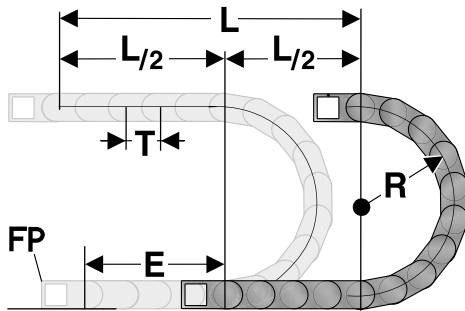

The fixed point of the energy chain should be connected in the middle of the travel distance.

This arrangement gives the shortest connection between the fixed point (FP) and the moving consumer and thus the most efficient chain length.

Chain length calculation =  $L/2 + \pi * R + E$   
 $\approx 1 \text{ m chain} = 11 \text{ qty. } \times 91.0 \text{ mm.}$

$E$  = Distance between entry point and middle of travel distance

$L$  = Travel distance

$R$  = Radius

$P$  = Pitch 91.0 mm

**INSTALLATION DIMENSIONS**

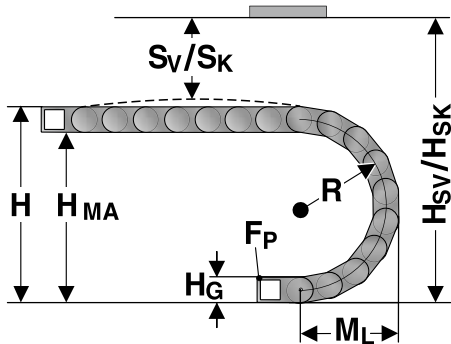

The moving end chain connection is to be screw fixed at height  $H_{MA}$  for the respective radius.

Concerning the installed dimensions, you must take into consideration whether the chain links are equipped with damping elements or not.

For chain links without damping elements, the value “Installed height with bias  $H_{sv}$  without damper” or “Installed height without bias  $H_{sk}$  without damper” must be taken into account.

If the chain links are equipped with a damping element, the value “Installed height with bias  $H_{sv}$  with damper” or “Installed height without bias  $H_{sk}$  with damper” is to be taken into account.

Radius R	135	150	175	200	250	300
Outside height of chain link ( $H_o$ )	84	84	84	84	84	84
Height of bend (H)	354	384	434	484	584	684
Height of moving end bracket ( $H_{MA}$ )	270	300	350	400	500	600
Safety margin with bias ( $S_v$ )	20	20	20	20	20	20
Installation height with bias ( $H_{sv}$ ) without damper	434	464	514	564	664	764
Installation height with bias ( $H_{sv}$ ) with damper	464	494	544	594	694	794
Safety margin without bias ( $S_k$ )	20	20	20	20	20	20
Installation height without bias ( $H_{sk}$ ) without damper	374	404	454	504	604	704
Installation height without bias ( $H_{sk}$ ) with damper	404	434	484	534	634	734
Arc projection ( $M_L$ )	268	283	308	333	383	433

**DAMPING ELEMENTS FOR THE SIDE LINKS**

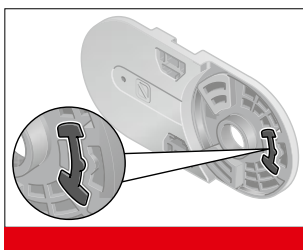

The damping elements in the stops facilitate a significantly quieter unrolling of the chain links. The dampers can be chosen optionally.

A reduction of the noise emission by up to 10 dB(A) comparing to the variants without the use of damping elements is possible.

## POWERLINE PLASTIC CROSSBAR



The crossbars connect the two side runs of the energy chain. The crossbar length is synonymous with the inside width of the energy chain.

Type	Order No.	Description	Inside width mm
RS 045-5	052004500000	Crossbar	45.0
RS 057-5	052005700000	Crossbar	57.0
RS 062-5	052006200000	Crossbar	62.0
RS 071-5	052007100000	Crossbar	71.0
RS 084-5	052008400000	Crossbar	84.0
RS 093-5	052009300000	Crossbar	93.0
RS 096-5	052009600000	Crossbar	96.0
RS 104-5	052010400000	Crossbar	104.0
RS 107-5	052010700000	Crossbar	107.0
RS 121-5	052012100000	Crossbar	121.0
RS 133-5	052013300000	Crossbar	133.0
RS 144-5	052014400000	Crossbar	144.0
RS 146-5	052014600000	Crossbar	146.0
RS 158-5	052015800000	Crossbar	158.0
RS 164-5	052016400000	Crossbar	164.0
RS 171-5	052017100000	Crossbar	171.0
RS 182-5	052018200000	Crossbar	182.0
RS 196-5	052019600000	Crossbar	196.0
RS 208-5	052020800000	Crossbar	208.0
RS 220-5	052022000000	Crossbar	220.0
RS 233-5	052023300000	Crossbar	233.0
RS 246-5	052024600000	Crossbar	246.0
RS 252-5	052025200010	Crossbar	252.0
RS 258-5	052025800000	Crossbar	258.0
RS 296-5	052029600000	Crossbar	296.0
RS 346-5	052034600000	Crossbar	346.0
RS 350-5	052035000000	Crossbar	350.0
RS 358-5	052035800000	Crossbar	358.0
RS 371-5	052037100000	Crossbar	371.0
RS 396-5	052039600000	Crossbar	396.0
RS 421-5	052042100000	Crossbar	421.0
RS 446-5	052044600000	Crossbar	446.0
RS 496-5	052049600000	Crossbar	496.0
RS 546-5	052054600000	Crossbar	546.0

## KA 62.4 CHAIN BRACKET FLEXIBLE

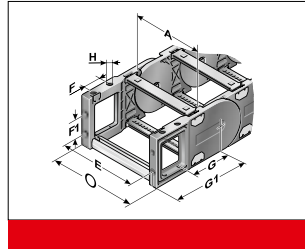
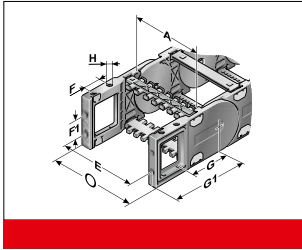

Questo attacco terminale di catena consente possibilità universali di fissaggio (sopra, sotto, frontalmente) e il collegamento alle ai pezzi ad U avviene nello stesso modo che tra pezzi ad U e pezzi ad U, ma alle estremità della catena. In tal modo, la catena è mobile fino al raccordo. Per ogni catena occorre un raccordo con perno e un raccordo con foro. Il fissaggio va eseguito con viti di dimensione M8. Le boccole in metallo incassate con foro passante (-FB) oppure con foro filettato (-FG), assicurano una trasmissione duratura e particolarmente resistente delle forze estreme sulla catena portacavi.

Type	Order No.	Material	Version	Inside width								Outside width of KA 01 mm
				A mm	E mm	F mm	F1 mm	G mm	G1 mm	H mm	H0 mm	
KA 62.4-FB Female end	0624000050	Plastic	with bush	45.0 – 546.0	A+16.0	20.0	45.0	85.0	125.0	9.0	A+34.0	
KA 62.4-FB Male end	0624000051	Plastic	with bush	45.0 – 546.0	A+16.0	20.0	45.0	85.0	125.0	9.0	A+34.0	
KA 62.4-FB Female end, pendular	0624000052	Plastic	with bush	45.0 – 546.0	A+16.0	20.0	45.0	85.0	125.0	9.0	A+34.0	
KA 62.4-FG Female end	0624000053	Plastic	with thread	45.0 – 546.0	A+16.0	20.0	45.0	85.0	125.0	M8	A+34.0	
KA 62.4-FG Female end, pendular	0624000055	Plastic	with thread	45.0 – 546.0	A+16.0	20.0	45.0	85.0	125.0	M8	A+34.0	
KA 62.4-FG Male end	0624000054	Plastic	with thread	45.0 – 546.0	A+16.0	20.0	45.0	85.0	125.0	M8	A+34.0	

## GS 62.4 SLIDING BLOCK

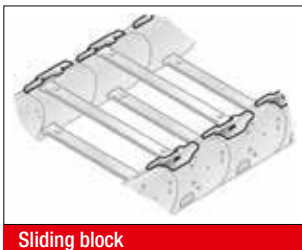

Sliding block

In the case of energy chains, sliding blocks are used in a horizontally sliding installation mode (the tight side of the chain slides on the slack side). The sliding blocks are set onto the side links on the interior bend instead of the usual crossbar interlocks; (no tools needed). This forces the chain to slide on the sliding blocks instead on the side links of the chain. Depending on the application, the service life of the energy chain may be extended five-fold, by using slide blocks. Information about the minimum bending radius of the energy chain at the sliding block insert is listed in the following table.

Type	Order No.	Installation site	Min. radius mm	Sliding block height mm
GS 62.4.1 right	062490400302	For right side link	175.0	4.0
GS 62.4.2 left	062490400300	For left side link	175.0	4.0

## GLP 5 (62.4) GLIDING PLATE

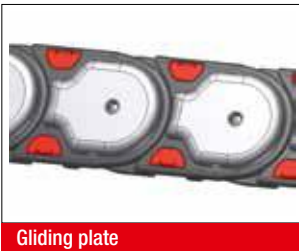

The gliding plates are mounted in a horizontal position, with the chain laying on its side, to minimize friction wear to the sides. They are mounted to the side links using a special screw. The wear limit is 2.5 mm. We recommend replacing the energy chain when this limit has been reached. Depending on the application, the service life of the energy chain may be extended two-fold, by using gliding plates. The energy chain must be placed on its side before opening.

Type	Order No.	Installation site	For radius mm	Gliding plate height mm
SG 62.4 RK135.1 right with GLP5, mounted	062400013566	Right chain link including gliding plate	135.0	7.0
SG 62.4 RK135.2 left with GLP5, mounted	062400013564	Left chain link including gliding plate	135.0	7.0
SG 62.4 RK150.1 right with GLP5, mounted	062400015066	Right chain link including gliding plate	150.0	7.0
SG 62.4 RK150.2 left with GLP5, mounted	062400015064	Left chain link including gliding plate	150.0	7.0
SG 62.4 RK175.1 right with GLP5, mounted	062400017566	Right chain link including gliding plate	175.0	7.0
SG 62.4 RK175.2 left with GLP5, mounted	062400017564	Left chain link including gliding plate	175.0	7.0
SG 62.4 RK200.1 right with GLP5, mounted	062400020066	Right chain link including gliding plate	200.0	7.0
SG 62.4 RK200.2 left with GLP5, mounted	062400020064	Left chain link including gliding plate	200.0	7.0
SG 62.4 RK250.1 right with GLP5, mounted	062400025066	Right chain link including gliding plate	250.0	7.0
SG 62.4 RK250.2 left with GLP5, mounted	062400025064	Left chain link including gliding plate	250.0	7.0
SG 62.4 RK300.1 right with GLP5, mounted	062400030066	Right chain link including gliding plate	300.0	7.0
SG 62.4 RK300.2 left with GLP5, mounted	062400030064	Left chain link including gliding plate	300.0	7.0
SG 62.4-D RK135.1 right with GLP5, mounted	062400013596	Right chain link including gliding plate	135.0	7.0
SG 62.4-D RK135.2 left with GLP5, mounted	062400013594	Left chain link including gliding plate	135.0	7.0
SG 62.4-D RK150.1 right with GLP5, mounted	062400015096	Right chain link including gliding plate	150.0	7.0
SG 62.4-D RK150.2 left with GLP5, mounted	062400015094	Left chain link including gliding plate	150.0	7.0
SG 62.4-D RK175.1 right with GLP5, mounted	062400017596	Right chain link including gliding plate	175.0	7.0
SG 62.4-D RK175.2 left with GLP5, mounted	062400017594	Left chain link including gliding plate	175.0	7.0
SG 62.4-D RK200.1 right with GLP5, mounted	062400020096	Right chain link including gliding plate	200.0	7.0
SG 62.4-D RK200.2 left with GLP5, mounted	062400020094	Left chain link including gliding plate	200.0	7.0
SG 62.4-D RK250.1 right with GLP5, mounted	062400025096	Right chain link including gliding plate	250.0	7.0
SG 62.4-D RK250.2 left with GLP5, mounted	062400025094	Left chain link including gliding plate	250.0	7.0
SG 62.4-D RK300.1 right with GLP5, mounted	062400030096	Right chain link including gliding plate	300.0	7.0
SG 62.4-D RK300.2 left with GLP5, mounted	062400030094	Left chain link including gliding plate	300.0	7.0

**TR 62.4 SEPARATOR**

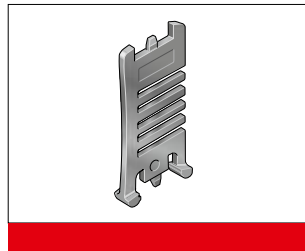
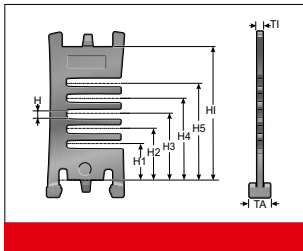

We recommend that separators be used if multiple round cables or conduits with differing diameters are to be installed.

Type	Order No.	Description	Version	TI mm	TA mm	H mm	H1 mm	H2 mm	H3 mm	H4 mm	H5 mm	HI mm
TR 62.4	062400009200	TR 62.4 Separator	lockable	3.5	11.0	4.0	17.0	24.0	31.0	38.0	45.0	62.0

**TR 62.4-V SEPARATOR**

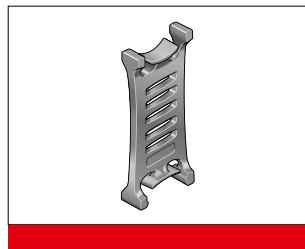
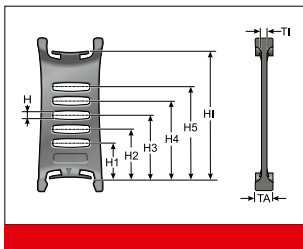

We recommend that separators be used if multiple round cables or conduits with differing diameters are to be installed.

Type	Order No.	Description	Version	TI mm	TA mm	H mm	H1 mm	H2 mm	H3 mm	H4 mm	H5 mm	HI mm
TR 62.4-V	062400009300	TR 62.4-V Separator	moveable	3.5	13.0	4.0	17.0	24.0	31.0	38.0	45.0	62.0

**RTT 62.4 SHELF SUPPORT, DIVISIBLE**

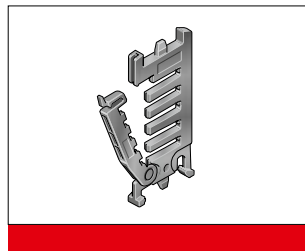
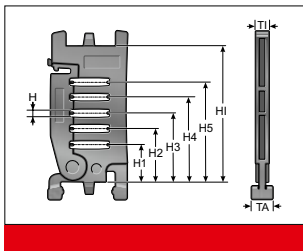

In connection with two separable shelf supports (RTT) with at least one end-to-end shelf (RB) the shelf becomes an easy to fill shelving system. The additional levels prevent cables from criss-crossing and minimise the friction between them.

Type	Order No.	Description	Version	TI mm	TA mm	H mm	H1 mm	H2 mm	H3 mm	H4 mm	H5 mm	HI mm
RTT 62.4	100090624000	Shelf support, divisible	lockable	7.0	11.0	4.0	17.0	24.0	31.0	38.0	45.0	62.0

**RSV 62.4 CROSSBAR CONNECTOR**



For crossbars wider than 246 mm, we recommend the use of crossbar connectors. These prevent deformation to the crossbar under large amounts of additional weight of the chain assembly.

Order No.	Description	TI mm
062400009700	Crossbar connector	6.0
062400009800	Crossbar connector for aluminium crossbars	6.0



## RB-5 SHELF

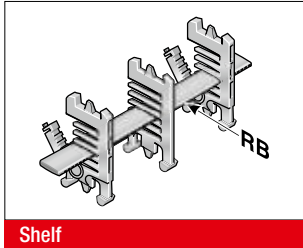

In connection with at least two separable shelf supports (RTT), the shelf becomes a shelving system. The additional levels prevent cables from criss-crossing and minimise the friction between them.

Type	Order No.	Description	Width mm	Inside width mm
RB 028-5	10000002800	Shelf	28.0	45.0
RB 034-5	1000003405	Shelf	33.6	45.0
RB 039-5	1000003905	Shelf	39.2	45.0
RB 045-5	1000004505	Shelf	44.8	57.0
RB 050-5	1000005005	Shelf	50.4	57.0
RB 056-5	10000005601	Shelf	56.0	62.0
RB 062-5	1000006205	Shelf	61.6	62.0
RB 067-5	1000006705	Shelf	67.2	84.0
RB 073-5	1000007305	Shelf	72.8	84.0
RB 078-5	1000007805	Shelf	78.4	84.0
RB 084-5	10000008400	Shelf	84.0	84.0
RB 090-5	1000009005	Shelf	89.6	96.0
RB 095-5	1000009505	Shelf	95.2	96.0
RB 101-5	1000010105	Shelf	100.8	107.0
RB 106-5	1000010605	Shelf	106.4	107.0
RB 112-5	100000011200	Shelf	112.0	121.0
RB 118-5	1000011805	Shelf	117.6	121.0
RB 123-5	1000012305	Shelf	123.2	133.0
RB 129-5	1000012905	Shelf	128.8	133.0
RB 134-5	1000013405	Shelf	134.4	144.0
RB 140-5	100000014000	Shelf	140.0	144.0
RB 146-5	1000014605	Shelf	145.6	158.0
RB 151-5	1000015105	Shelf	151.2	158.0
RB 157-5	1000015705	Shelf	156.8	164.0
RB 162-5	1000016205	Shelf	162.4	164.0
RB 168-5	100000016800	Shelf	168.0	182.0
RB 174-5	1000017405	Shelf	173.6	182.0
RB 179-5	1000017905	Shelf	179.2	196.0
RB 185-5	1000018505	Shelf	184.8	196.0
RB 190-5	1000019005	Shelf	190.4	196.0
RB 196-5	100000019600	Shelf	196.0	196.0
RB 291-5	100000029100	Shelf	291.2	346.0

**BS-5 BRACKET BAR**



Large-diameter conduits are routed securely by using a bracket bar (BS). This bar is installed on the crossbars or the covers of the energy chain.

The bracket bar can be installed on both the inside and outside bend.

The bracket bar support (BSH) is used to attach the bars to PowerLine series crossbars. Two bracket bar supports are required for each bar.

Type	Order No.	Description	Conduit diameter max. mm	Installation height mm	Inner chain width min. mm
BS 120-5	052412000000	Bracket bar	115.0	140.0	164.0
BS 153-5	052415300000	Bracket bar	148.0	170.0	208.0
BS 187-5	052418700000	Bracket bar	182.0	205.0	233.0
BSH-5	052400000000	Bracket bar support			
Assembly set	052400000001	Assembly set			

**D5 CHAIN BRACKET COVER**

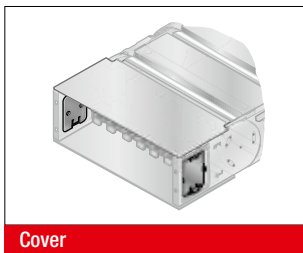

Self-locking covers close the side mounting window on the flexible chain bracket (KA-FB/FG).

Type	Order No.
D5 Cover	0523888002

**RS-ZL-5 CROSSBAR STRAIN RELIEF PLATE**

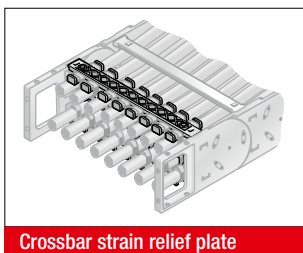

Fixed integrated frame bridge strain relief plates in the chain brackets. Tailored to all crossbar widths up to 246 mm. May be assembled on the inside and outside bends at both chain endings.

Type	Order No.	Description	Inside width mm
RS-ZL 045-5	052004500010	Crossbar strain relief plate	45.0
RS-ZL 057-5	052005700010	Crossbar strain relief plate	57.0
RS-ZL 062-5	052006200010	Crossbar strain relief plate	62.0
RS-ZL 071-5	052007100010	Crossbar strain relief plate	71.0
RS-ZL 084-5	052008400010	Crossbar strain relief plate	84.0
RS-ZL 093-5	052009300010	Crossbar strain relief plate	93.0
RS-ZL 096-5	052009600010	Crossbar strain relief plate	96.0
RS-ZL 104-5	052010400010	Crossbar strain relief plate	104.0
RS-ZL 107-5	052010700010	Crossbar strain relief plate	107.0
RS-ZL 121-5	052012100010	Crossbar strain relief plate	121.0

## RS-ZL-5 CROSSBAR STRAIN RELIEF PLATE

Type	Order No.	Description	Inside width mm
RS-ZL 133-5	052013300010	Crossbar strain relief plate	133.0
RS-ZL 144-5	052014400010	Crossbar strain relief plate	144.0
RS-ZL 146-5	052014600010	Crossbar strain relief plate	146.0
RS-ZL 158-5	052015800010	Crossbar strain relief plate	158.0
RS-ZL 164-5	052016400010	Crossbar strain relief plate	164.0
RS-ZL 171-5	052017100010	Crossbar strain relief plate	171.0
RS-ZL 182-5	052018200010	Crossbar strain relief plate	182.0
RS-ZL 196-5	052019600010	Crossbar strain relief plate	196.0
RS-ZL 208-5	052020800010	Crossbar strain relief plate	208.0
RS-ZL 220-5	052022000010	Crossbar strain relief plate	220.0
RS-ZL 233-5	052023300010	Crossbar strain relief plate	233.0
RS-ZL 246-5	052024600010	Crossbar strain relief plate	246.0

## STRAIN RELIEF WITH STEEL FIX

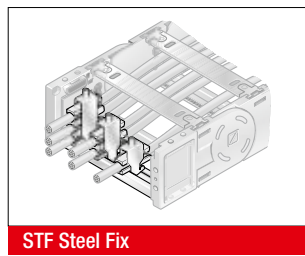
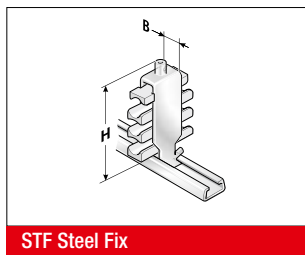

C-rails (galvanised) for permanent integration, for accommodating the Steel Fix bow clamps in the chain brackets. The bow clamps can take up to 3 cables and are suitable for C-rails with a groove width of 11 mm. Due to the design of the trough elements, a cable preserving cable guidance is ensured. May be assembled on the inside and outside bends at both chain endings. The overall height stated is a guide only. The actual height is, amongst other things, dependent on the diameter and the quality of the cable. A safety distance of 10 mm at the fixed point above the strain relief must be kept during gliding applications.

Type	Order No.	Designation	Seats qty.	Cable Ø mm	Width mm	Overall height (H) mm
<b>Single clamp (for one cable)</b>						
STF 12-1 Steel Fix	81661801	Hooped clamp	1	6.0 – 12.0	16.0	55.0
STF 14-1 Steel Fix	81661802	Hooped clamp	1	12.0 – 14.0	18.0	52.0
STF 16-1 Steel Fix	81661803	Hooped clamp	1	14.0 – 16.0	20.0	54.0
STF 18-1 Steel Fix	81661804	Hooped clamp	1	16.0 – 18.0	22.0	56.0
STF 20-1 Steel Fix	81661805	Hooped clamp	1	18.0 – 20.0	24.0	59.0
STF 22-1 Steel Fix	81661806	Hooped clamp	1	20.0 – 22.0	26.0	61.0
STF 26-1 Steel Fix	81661807	Hooped clamp	1	22.0 – 26.0	30.0	70.0
STF 30-1 Steel Fix	81661808	Hooped clamp	1	26.0 – 30.0	34.0	74.0
STF 34-1 Steel Fix	81661809	Hooped clamp	1	30.0 – 34.0	38.0	78.0
STF 38-1 Steel Fix	81661810	Hooped clamp	1	34.0 – 38.0	42.0	82.0
STF 42-1 Steel Fix	81661811	Hooped clamp	1	38.0 – 42.0	46.0	91.0
<b>Double clamp (for two cables)</b>						
STF 12-2 Steel Fix	81661821	Hooped clamp	2	6.0 – 12.0	16.0	73.0
STF 14-2 Steel Fix	81661822	Hooped clamp	2	12.0 – 14.0	18.0	74.0
STF 16-2 Steel Fix	81661823	Hooped clamp	2	14.0 – 16.0	20.0	82.0
STF 18-2 Steel Fix	81661824	Hooped clamp	2	16.0 – 18.0	22.0	86.0
STF 20-2 Steel Fix	81661825	Hooped clamp	2	18.0 – 20.0	24.0	91.0
STF 22-2 Steel Fix	81661826	Hooped clamp	2	20.0 – 22.0	26.0	95.0
STF 26-2 Steel Fix	81661827	Hooped clamp	2	22.0 – 26.0	30.0	108.0
STF 30-2 Steel Fix	81661828	Hooped clamp	2	26.0 – 30.0	34.0	121.0
STF 34-2 Steel Fix	81661829	Hooped clamp	2	30.0 – 34.0	38.0	129.0
<b>Triple clamp (for three cables)</b>						
STF 12-3 Steel Fix	81661841	Hooped clamp	3	6.0 – 12.0	16.0	98.0

## MP 62.4 OPEN

Type	Order No.	Designation	Seats qty.	Cable Ø mm	Width mm	Overall height (H) mm
STF 14-3 Steel Fix	81661842	Hooped clamp	3	12.0 – 14.0	18.0	98.0
STF 16-3 Steel Fix	81661843	Hooped clamp	3	14.0 – 16.0	20.0	105.0
STF 18-3 Steel Fix	81661844	Hooped clamp	3	16.0 – 18.0	22.0	111.0
STF 20-3 Steel Fix	81661845	Hooped clamp	3	18.0 – 20.0	24.0	118.0
STF 22-3 Steel Fix	81661846	Hooped clamp	3	20.0 – 22.0	26.0	130.0

## MP 52/62/72 LOCK BUTTON

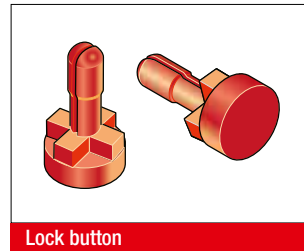
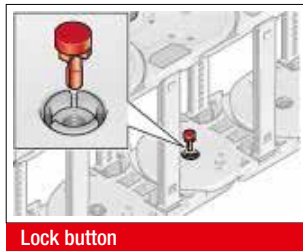
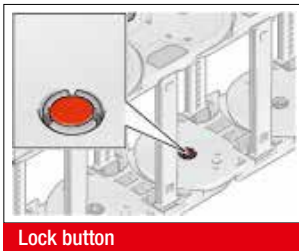

To increase the side stability, we recommend the use of lock buttons during strong lateral acceleration or when installed

“laying on the side (turned 90°) without support”.

Type	Order No.
MP52/62/72 lock button	0520000080

## MP 62.4 LOWERED FIXING POINT

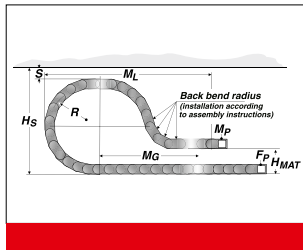
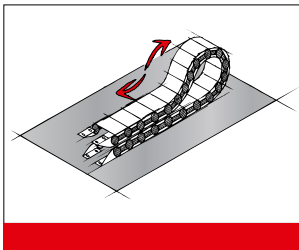

It is sometimes necessary to lower the height of the moving attachment point.

In such cases, modifications to the chain layout should be noted (e.g. extension of chain).

Please contact our application engineers.

Radius R mm	Height of moving end bracket (H <sub>MA</sub> ) mm	Safety margin (S) mm	Installation height incl. safety (H <sub>S</sub> ) mm	Projection (M <sub>L</sub> ) mm	Additional links qty.	of which additional back chain links qty.
175.0	180.0	50.0	484.0	620.0	6	3
200.0	210.0	50.0	534.0	830.0	10	3
250.0	250.0	50.0	634.0	990.0	13	3
300.0	300.0	50.0	734.0	900.0	14	3

## MP 62.4 REARWARD RADII

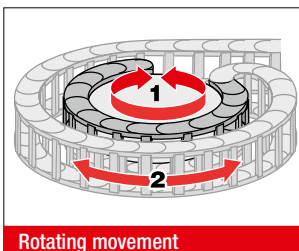

Side links with rearward radius allow movements in both directions. This is intended for rotating movements and lowered chain brackets. Note: This type of chain has different chain links for the left or right side! Rotation movements are only possible with open variants.

Type	Order No.	Radius mm	Rearward radius mm
SR 62.4 (RÜ200/R150.2) left	062400015060	150.0	200.0
SR 62.4 (RÜ200/R150.1) right	062400015062	150.0	200.0
SR 62.4 (RÜ200/R200.2) left	062400020060	200.0	200.0
SR 62.4 (RÜ200/R200.1) right	062400020062	200.0	200.0

**GUIDE CHANNEL VAW (ALUMINIUM / STAINLESS STEEL)**



VAW steel galvanised / stainless steel



VAW aluminium

A range of variable guide channel systems, constructed from aluminium or stainless steel sections, are available for this energy chain.

The variable guide channel ensures that the energy chain is supported and guided securely.

**ASSEMBLY**

**DISASSEMBLY**

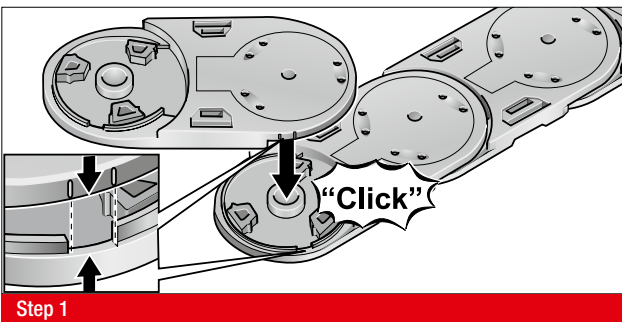

Step 1

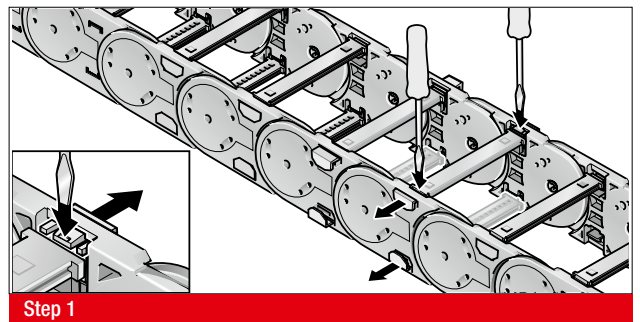

Step 1

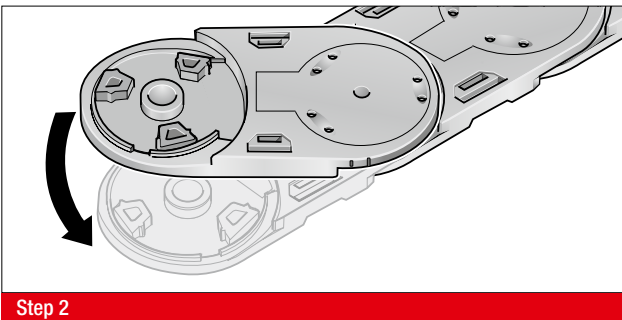

Step 2

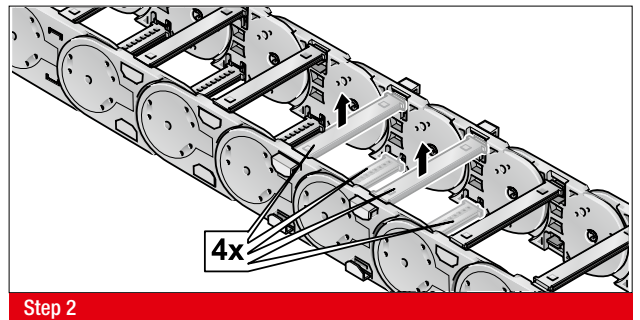

Step 2

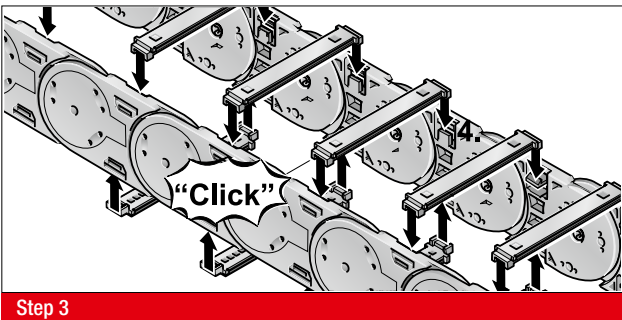

Step 3

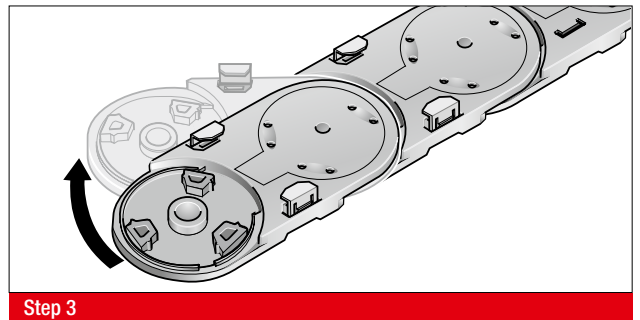

Step 3

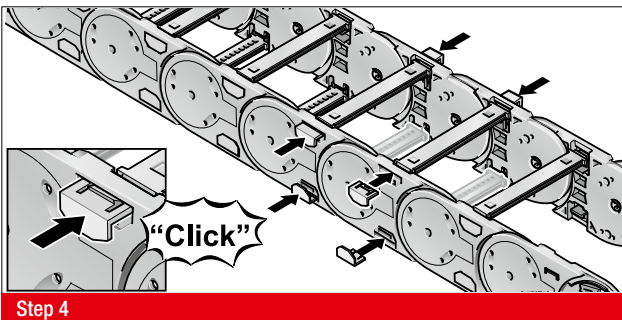

Step 4

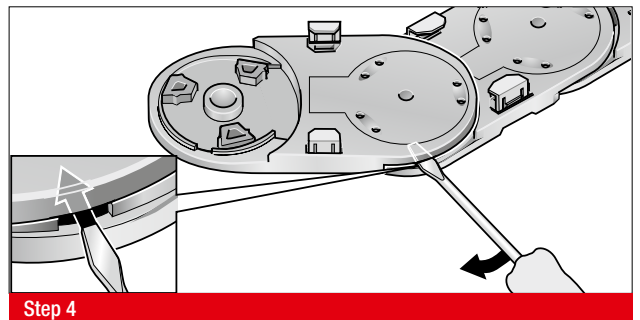

Step 4

**MP 62.2**  
OPEN

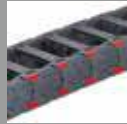

**MP 62.3**  
CLOSED



- SLIDING BLOCKS FOR LONGER SERVICE LIFE
- BROAD INTERIOR LAYOUT
- CHAIN BRACKET FLEXIBLE
- PLASTIC OR ALUMINIUM VERSION

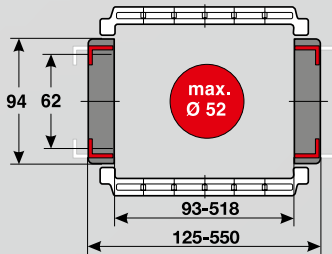

## TECHNICAL DATA

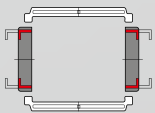

**Loading side**  
Inside and outside bend

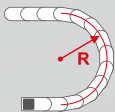

**Available radii**  
150.0 – 500.0 mm

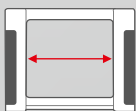

**Available interior widths**  
With plastic crossbar  
93.0 – 518.0 mm  
With alu crossbar / with alu cover  
72.0 – 600.0 mm / 40.0 – 600.0 mm

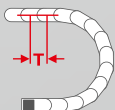

**Pitch**  
T = 100.0 mm

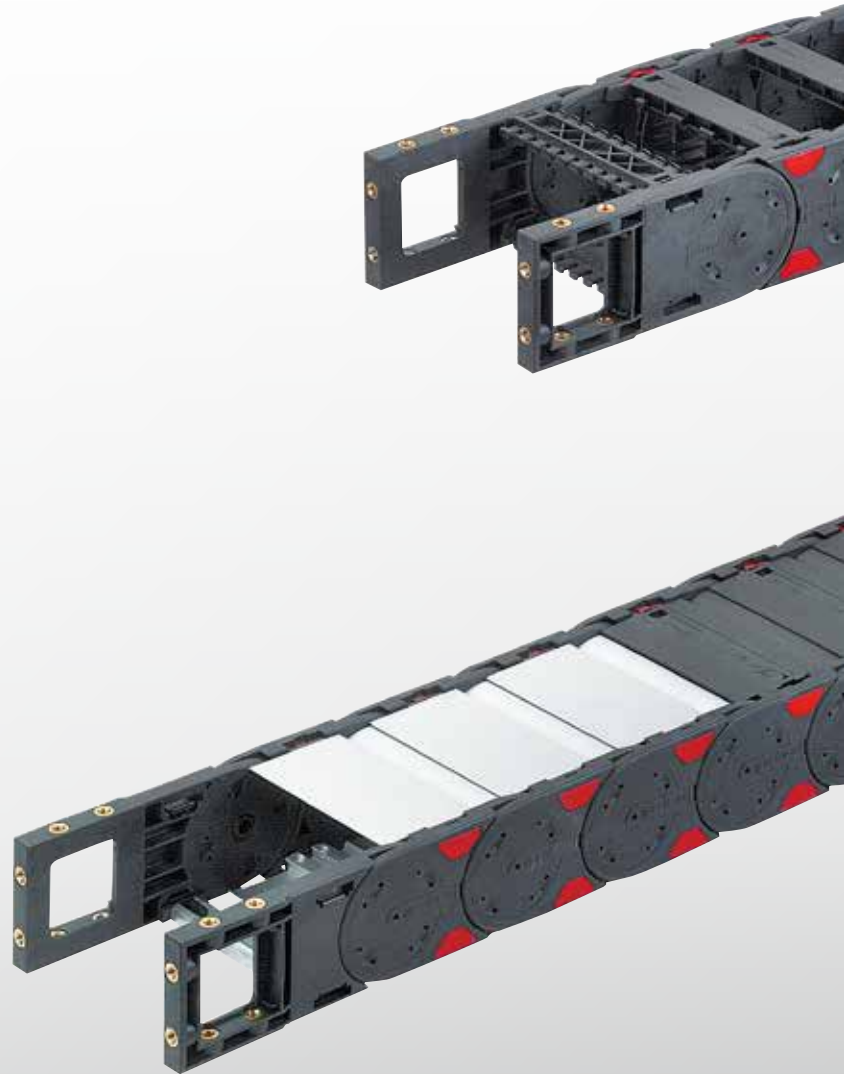



## TECHNICAL SPECIFICATIONS

Travel distance gliding $L_g$ max.	150.0 m
Travel distance self-supporting $L_s$ max.	see diagram on page 293
Travel distance vertical, hanging $L_{vh}$ max.	65.0 m
Travel distance vertical, upright $L_{vs}$ max.	6.0 m
Rotated 90°, unsupported $L_{90f}$ max.	4.0 m
Speed, gliding $V_g$ max.	5.0 m/s
Speed, self-supporting $V_f$ max.	20.0 m/s
Acceleration, gliding $a_g$ max.	25.0 m/s <sup>2</sup>
Acceleration, self-supporting $a_s$ max.	40.0 m/s <sup>2</sup>

Contact our engineering department to meet any higher requirements: [efk@murrplastik.de](mailto:efk@murrplastik.de)

## MATERIAL PROPERTIES

Standard material	Polyamide (PA) black
Service temperature	-30.0 – 120.0 °C
Gliding friction factor	0.3
Static friction factor	0.45
Fire classification	UL 94 HB

Other material properties on request.

## ACCESSORIES



Sliding block

## SHELVING SYSTEM



Separator TR



Bracket bar

## CHAIN BRACKET

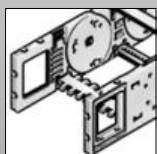

Chain bracket flexible



RS shelving system



Cover

## GUIDE CHANNELS



VAW steel galvanised / stainless steel

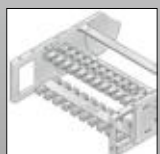

RS-ZL crossbar strain relief

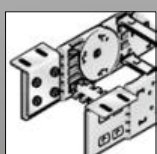

Chain bracket angle



Crossbar connector RSV

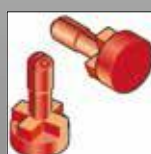

Lock button

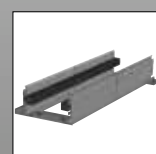

VAW aluminium

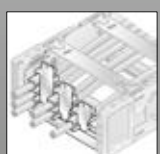

STF Steel Fix

**ORDERING KEY**

Dimensions in mm [US inch]

Type code	Variation	Inside width	Outside width	Inside width	Outside width	Radius	Crossbar variant	Material	Chain length
<b>0622 30</b>	MP 62.2 open Crossbar on outside bend Crossbar on inside bend Opens on inside and outside bend	<b>093</b> [3.66]	<b>125</b> [4.92]	<b>468</b> [18.43]	<b>500</b> [19.69]	<b>150<sup>1)</sup></b> [5.91]	<b>0</b> Plastic, full-ridged with bias	<b>0</b> Polyamide standard (PA/black)	
		<b>106</b> [4.17]	<b>138</b> [5.43]	<b>518</b> [20.39]	<b>550</b> [21.65]				
<b>0623 44</b>	MP 62.3 Closed Cover on outside bend Cover on inside bend Opens on inside and outside bend	<b>118<sup>2)</sup></b> [4.65]	<b>150</b> [5.91]			<b>200</b> [7.87]	<b>1</b> Plastic, full-ridged without bias	<b>5</b> Polypropylene (PP/blue)	
		<b>131</b> [5.16]	<b>163</b> [6.42]						
		<b>143<sup>2)</sup></b> [5.63]	<b>175</b> [6.89]			<b>250</b> [9.84]	<b>2</b> Plastic, half-ridged with bias	<b>7</b> EMC (PA/light grey)	
		<b>156</b> [6.14]	<b>188</b> [7.40]						
		<b>168</b> [6.61]	<b>200</b> [7.87]			<b>300</b> [11.81]	<b>3</b> Plastic, half-ridged without bias	<b>9</b> Special version (on request)	
		<b>181</b> [7.13]	<b>213</b> [8.39]						
		<b>193<sup>2)</sup></b> [7.60]	<b>225</b> [8.86]			<b>350</b> [13.78]	<b>4</b> Aluminium full-ridged with bias		
		<b>206</b> [8.11]	<b>238</b> [9.37]						
		<b>218</b> [8.58]	<b>250</b> [9.84]			<b>400</b> [15.75]	<b>5</b> Aluminium full-ridged without bias		
		<b>231</b> [9.09]	<b>263</b> [10.35]						
		<b>243<sup>2)</sup></b> [9.57]	<b>275</b> [10.83]			<b>500</b> [19.69]	<b>6</b> Aluminium half-ridged with bias		
		<b>256</b> [10.08]	<b>288</b> [11.34]						
		<b>268</b> [10.55]	<b>300</b> [11.81]				<b>7</b> Aluminium half-ridged without bias		
		<b>293<sup>2)</sup></b> [11.54]	<b>325</b> [12.80]						
		<b>318</b> [12.52]	<b>350</b> [13.78]				<b>9</b> Special version (on request)		
		<b>343<sup>2)</sup></b> [13.50]	<b>375</b> [14.76]						
		<b>368</b> [14.49]	<b>400</b> [15.75]						
		<b>418<sup>2)</sup></b> [16.46]	<b>450</b> [17.72]						

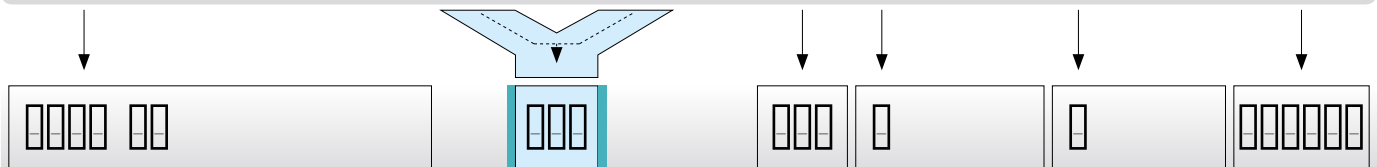

**ORDERING EXAMPLE: 0622 30 118 150 0 0 1600**

Crossbar on outside bend, crossbar on inside bend, can be opened from inside and outside bend  
 Inside width 118 mm; radius 150 mm  
 Plastic crossbar, full-ridged with bias, material black-coloured polyamide  
 Chain length 1600 mm (16 links)

<sup>1)</sup> for Variant 30 only  
<sup>2)</sup> also available with plastic cover



**NOTE ON CONFIGURATION**

**Aluminium crossbars:**

Aluminium crossbars can be supplied in 1 mm width sizes for inner widths from 72.0 mm – 600.0 mm .

**Aluminium covers:**

Aluminium covers can be supplied in 1 mm width sizes for inner widths from 40.0 mm – 600.0 mm .

**Crossbar connector and crossbar strain relief plate:**

Once inside widths exceed 243 mm, we recommend the deployment of crossbar connectors (RSV). Crossbar connectors cannot be used in conjunction with covers made from plastic or aluminium.

If crossbar strain relief plates (RS-ZL) are to be deployed in the chain brackets, take standard inside widths into account.

For detailed information, please consult the corresponding product documentation.

**SELF-SUPPORTING LENGTH**

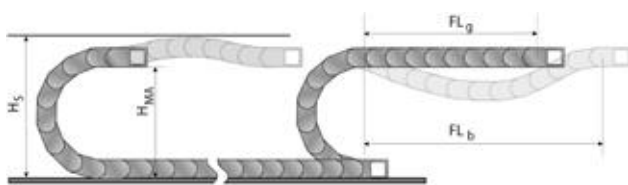

The self-supporting length is the distance between the chain bracket on the moving end and the start of the chain arch. The installation variant  $FL_g$  offers the lowest load and wear for the energy chain. The maximum travel parameters (speed and acceleration) can be applied for this variant.

- $H_s$  = Installation height plus safety
- $H_{MA}$  = Height of moving end connection
- $FL_g$  = Self-supporting length, upper run straight
- $FL_b$  = Self-supporting length, upper run bent

**LOAD DIAGRAM FOR SELF-SUPPORTING APPLICATIONS**

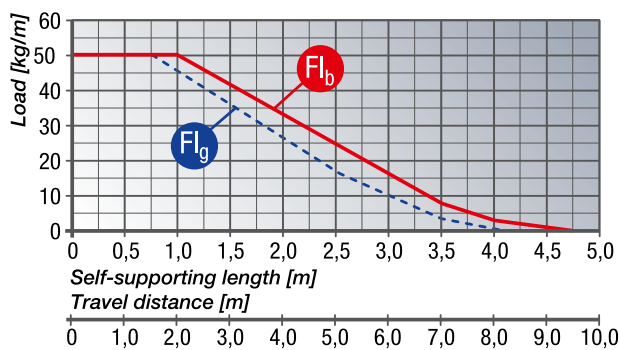

**$FL_g$  Self-supporting length, upper run straight**

In the  $FL_g$  range, the chain upper run still has a bias, is straight or has a maximum sag of 80.0 mm.

**$FL_b$  Self-supporting length, upper run bent**

In the  $FL_b$  range, the chain upper run has a sag of more than 80.0 mm, but this is still less than the maximum sag. Where the sag is greater than that permitted in the  $FL_b$  range, the application is critical and should be avoided. The self-supporting length can be optimised by using a support for the upper run or a more stable energy chain. Closed energy chains (with covers) have a higher unit weight than open chains (with crossbars). This higher weight must be taken into account when calculating the self-supporting length. To the weight of the cabling (cable load, in kg/m), you must add 3.1 kg/m, to account for the higher weight of closed-cover chains.

**DETERMINING THE CHAIN LENGTH**

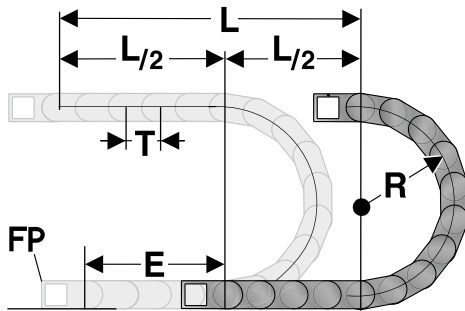

The fixed point of the energy chain should be connected in the middle of the travel distance.

This arrangement gives the shortest connection between the fixed point (FP) and the moving consumer and thus the most efficient chain length.

Chain length calculation =  $L/2 + \pi * R + E$   
 $\approx 1 \text{ m chain} = 10 \text{ qty. } \times 100.0 \text{ mm.}$

- E = Distance between entry point and middle of travel distance
- L = Travel distance
- R = Radius
- P = Pitch 100.0 mm

**INSTALLATION DIMENSIONS**

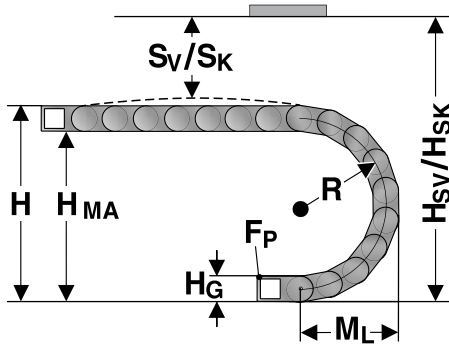

The moving end chain connection is to be screw fixed at height  $H_{MA}$  for the respective radius.

Concerning the installed dimensions, you must take into account whether the chain links are equipped with or without bias.

For chain links without bias, the "Installed height without bias  $H_{SK}$ " value has to be taken into account.

If the chain links are equipped with a bias, the value "Installed height with bias  $H_{SV}$ " has to be taken into account.

Radius R	150	200	250	300	350	400	500
Outside height of chain link ( $H_G$ )	94	94	94	94	94	94	94
Height of bend (H)	424	524	624	724	824	924	1124
Height of moving end bracket ( $H_{MA}$ )	330	430	530	630	730	830	1030
Safety margin with bias ( $S_v$ )	50	50	50	50	50	50	50
Installation height with bias ( $H_{sv}$ )	474	574	674	774	874	974	1174
Safety margin without bias ( $S_r$ )	20	20	20	20	20	20	20
Installation height without bias ( $H_{sk}$ )	444	544	644	744	844	944	1144
Arc projection ( $M_L$ )	312	362	412	462	512	562	662

**HEAVYLINE PLASTIC CROSSBAR**



The crossbars connect the two side runs of the energy chain. The crossbar length is synonymous with the inside width of the energy chain.

Type	Order No.	Description	Inside width mm
RS 093-7	072009300000	Crossbar	93.0
RS 106-7	072010600000	Crossbar	106.0
RS 118-7	072011800000	Crossbar	118.0
RS 131-7	072013100000	Crossbar	131.0
RS 143-7	072014300000	Crossbar	143.0

## HEAVYLINE PLASTIC CROSSBAR

Type	Order No.	Description	Inside width mm
RS 156-7	072015600000	Crossbar	156.0
RS 168-7	072016800000	Crossbar	168.0
RS 181-7	072018100000	Crossbar	181.0
RS 193-7	072019300000	Crossbar	193.0
RS 206-7	072020600000	Crossbar	206.0
RS 231-7	072023100000	Crossbar	231.0
RS 243-7	072024300000	Crossbar	243.0
RS 256-7	072025600000	Crossbar	256.0
RS 268-7	072026800000	Crossbar	268.0
RS 293-7	072029300000	Crossbar	293.0
RS 318-7	072031800000	Crossbar	318.0
RS 343-7	072034300000	Crossbar	343.0
RS 368-7	072036800000	Crossbar	368.0
RS 418-7	072041800000	Crossbar	418.0
RS 468-7	072046800000	Crossbar	468.0
RS 518-7	072051800000	Crossbar	518.0

## MP 62.3 PLASTIC COVER



Cover

The covers connect the two side runs of the energy chain. The cover length is synonymous with the inside width of the energy chain.

Type	Order No.	Description	Installation site	Inside width mm
A-623118, outside	062311810000	Cover	Outside bend	118.0
I-623118, inside	062311820000	Cover	Inside bend	118.0
A-623143, outside	062314310000	Cover	Outside bend	143.0
I-623143, inside	062314320000	Cover	Inside bend	143.0
A-623193, outside	062319310000	Cover	Outside bend	193.0
I-623193, inside	062319320000	Cover	Inside bend	193.0
A-623243, outside	062324310000	Cover	Outside bend	243.0
I-623243, inside	062324320000	Cover	Inside bend	243.0
A-623293, outside	062329310000	Cover	Outside bend	293.0
I-623293, inside	062329320000	Cover	Inside bend	293.0
A-623343, outside	062334310000	Cover	Outside bend	343.0
I-623343, inside	062334320000	Cover	Inside bend	343.0
A-623418, outside	062341810000	Cover	Outside bend	418.0
I-623418, inside	062341820000	Cover	Inside bend	418.0

**KA 62.1 CHAIN BRACKET FLEXIBLE**

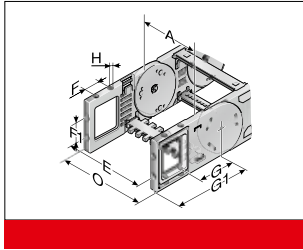

This chain bracket offers universal connection options (top, bottom and front) and is attached to the ends of the chain like a side link. This allows the chain to move right up to the bracket. Each chain requires one male and one female bracket. M8 screws are used to secure the brackets in place. Extrusion-coated metal bushes with either a through-hole (-FB) or a threaded hole (-FG) ensure the permanent, high-strength transmission of even extreme forces onto the energy chain.

Type	Order No.	Material	Version	Inside width								Outside width of KA 0 mm
				A mm	E mm	F mm	F1 mm	G mm	G1 mm	H mm	H0 mm	
KA 62-FB Female end	0620000056	Plastic	with bush	93.0 – 518.0	A+17.0	35.0	45.0	107.0	171.5	8.5	A+36.0	
KA 62-FB male end	0620000057	Plastic	with bush	93.0 – 518.0	A+17.0	35.0	45.0	107.0	171.5	8.5	A+36.0	
KA 62-FG Female end	0620000058	Plastic	with thread	93.0 – 518.0	A+17.0	35.0	45.0	107.0	171.5	M8	A+36.0	
KA 62-FG male end	0620000059	Plastic	with thread	93.0 – 518.0	A+17.0	35.0	45.0	107.0	171.5	M8	A+36.0	

**KA 62.1 CHAIN BRACKET ANGLE**

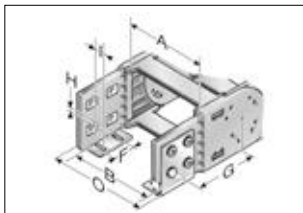

KA 62 (inside up / down)

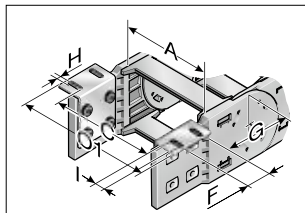

KA 62 (outside up / down)

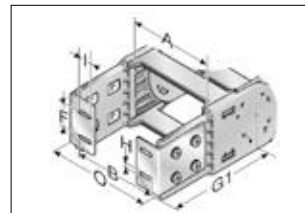

KA 62 (front inside)

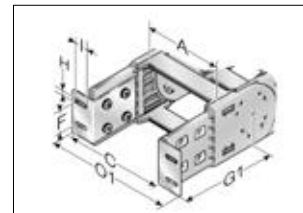

KA 62 (front outside)

This chain bracket offers universal connection options (top, bottom and front) and is attached to the ends of the chain like a side link. This allows the chain to move right up to the bracket. Each chain requires one male and one female bracket. M8

screws are used to secure the brackets in place. Metal inserts (supplied) help to minimise the cold flow properties. This is an enormous advantage, guaranteeing the smooth transfer of high loads to the chain.

Type	Order No.	Material	Inside width								Outside width of KA 0 mm	Outside width of KA 01 mm
			A mm	B mm	C mm	F mm	G mm	G1 mm	H0 mm	I mm		
KA 62 Female end	0620000050	Sheet steel	93.0 – 518.0	A-12.0	A+44.0	45.0	102.0	171.5	9.0	15.0	A+32.0	A+90.0
KA 62 Male end	0620000051	Sheet steel	93.0 – 518.0	A-12.0	A+44.0	45.0	102.0	171.5	9.0	15.0	A+32.0	A+90.0

**MP 52/62/72 LOCK BUTTON**

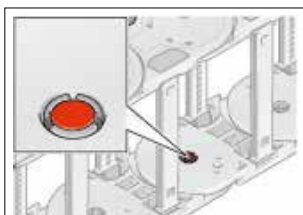

Lock button

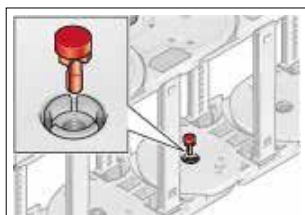

Lock button

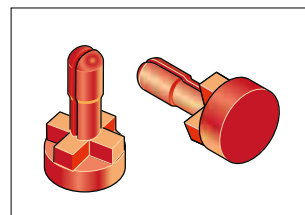

Lock button

To increase the side stability, we recommend the use of lock buttons during strong lateral acceleration or when installed

“laying on the side (turned 90°) without support”.

Type	Order No.
MP52/62/72 lock button	0520000080

**GS 62.2 SLIDING BLOCK**

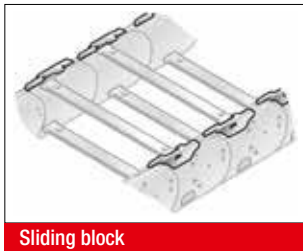

In the case of energy chains, sliding blocks are used in a horizontally sliding installation mode (the tight side of the chain slides on the slack side). The sliding blocks are set onto the side links on the interior bend instead of the usual crossbar interlocks; (no tools needed). This forces the chain to slide on the sliding blocks instead on the side links of the chain. Depending on the application, the service life of the energy chain may be extended five-fold, by using slide blocks. Information about the minimum bending radius of the energy chain at the sliding block insert is listed in the following table.

Type	Order No.	Installation site	Min. radius mm	Sliding block height mm
GS 62.2.1 right	062290400302	For right side link	200.0	6.0
GS 62.2.2 left	062290400300	For left side link	200.0	6.0

**TR 62 SEPARATOR**

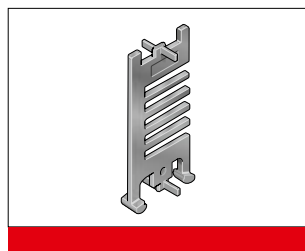
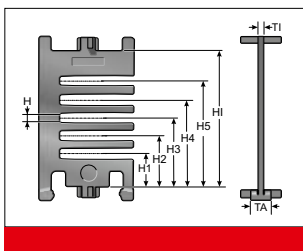

We recommend that separators be used if multiple round cables or conduits with differing diameters are to be installed.

Type	Order No.	Description	Version	TI mm	TA mm	H mm	H1 mm	H2 mm	H3 mm	H4 mm	H5 mm	Hl mm
TR 62	062000009200	Separator	lockable	3.5	13.0	5.5	14.8	23.1	31.4	39.7	48.0	62.0

**RTT 62 SHELF SUPPORT, DIVISIBLE**

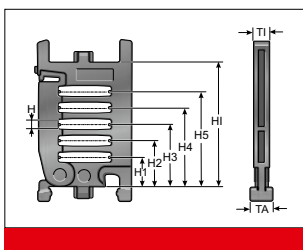

In connection with two separable shelf supports (RTT) with at least one end-to-end shelf (RB) the shelf becomes an easy to fill shelving system. The additional levels prevent cables from criss-crossing and minimise the friction between them.

Type	Order No.	Description	Version	TI mm	TA mm	H mm	H1 mm	H2 mm	H3 mm	H4 mm	H5 mm	Hl mm
RTT 62	100090622000	Shelf support, divisible	lockable	8.0	8.0	5.5	14.8	23.1	31.4	39.7	48.0	62.0

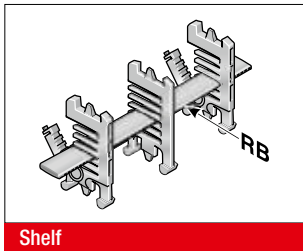
**RB-7 SHELF**

In connection with at least two separable shelf supports (RTT), the shelf becomes a shelving system. The additional levels prevent cables from criss-crossing and minimise the friction between them.

Type	Order No.	Description	Width mm	Inside width mm
RB 056-7	100000005600	Shelf	56.0	93.0
RB 061-7	1000006107	Shelf	61.0	93.0
RB 066-7	100000006600	Shelf	66.0	93.0
RB 071-7	1000007107	Shelf	71.0	93.0
RB 076-7	1000007607	Shelf	76.0	93.0
RB 081-7	100000008100	Shelf	81.0	93.0
RB 086-7	1000008607	Shelf	86.0	93.0
RB 091-7	1000009107	Shelf	91.0	106.0
RB 096-7	1000009607	Shelf	96.0	106.0
RB 101-7	1000010107	Shelf	101.0	106.0
RB 106-7	100000010600	Shelf	106.0	106.0
RB 111-7	1000011107	Shelf	111.0	118.0
RB 116-7	100000011600	Shelf	116.0	118.0
RB 121-7	1000012107	Shelf	121.0	131.0
RB 126-7	1000012607	Shelf	126.0	131.0
RB 131-7	1000013107	Shelf	131.0	143.0
RB 136-7	1000013607	Shelf	136.0	143.0
RB 141-7	1000014107	Shelf	141.0	143.0
RB 146-7	1000014607	Shelf	146.0	156.0
RB 151-7	1000015107	Shelf	151.0	156.0
RB 156-7	1000015607	Shelf	156.0	156.0
RB 161-7	1000016107	Shelf	161.0	168.0
RB 166-7	100000016600	Shelf	166.0	168.0
RB 171-7	1000017107	Shelf	171.0	181.0
RB 176-7	1000017607	Shelf	176.0	181.0
RB 181-7	1000018107	Shelf	181.0	193.0
RB 186-7	1000018607	Shelf	186.0	193.0
RB 191-7	1000019107	Shelf	191.0	193.0
RB 196-7	1000019607	Shelf	196.0	206.0
RB 201-7	1000020107	Shelf	201.0	206.0
RB 206-7	1000020607	Shelf	206.0	206.0
RB 211-7	1000021107	Shelf	211.0	218.0
RB 216-7	100000021600	Shelf	216.0	218.0

### RSV 62 CROSSBAR CONNECTOR



For crossbars wider than 246 mm, we recommend the use of crossbar connectors. These prevent deformation to the crossbar under large amounts of additional weight of the chain assembly.

Type	Order No.	Description	TI mm
RSV 62	062000009600	Crossbar connector	8.0
RSV 62 Alu	062000009800	Crossbar connector for aluminium crossbars	8.0

### BS-5 BRACKET BAR



Large-diameter conduits are routed securely by using a bracket bar (BS). This bar is installed on the crossbars or the covers of the energy chain.

The bracket bar can be installed on both the inside and outside bend.

The bracket bar support (BSH) is used to attach the bars to PowerLine series crossbars. Two bracket bar supports are required for each bar.

Type	Order No.	Description	Conduit diameter max. mm	Installation height mm	Inner chain width min. mm
BS 120-5	052412000000	Bracket bar	115.0	140.0	164.0
BS 153-5	052415300000	Bracket bar	148.0	170.0	208.0
BS 187-5	052418700000	Bracket bar	182.0	205.0	233.0
Assembly set	052400000001	Assembly set			

### D6 CHAIN BRACKET COVER



Self-locking covers close the side mounting window on the flexible chain bracket (KA-FB/FG).

Type	Order No.
Cover D6 KA 62.1-FB/FG	0623888002

**MP 62.3 CHAIN BRACKET CANOPY**



Constructed from aluminium, the canopies for the flexible chain bracket (KA-FB/FG) ensure a continuously closed system for chains with covers.

**Canopy for chain bracket fixed point outside bend: Type and order number configurator**



Type:	KA 62.1 FB/FG AB	Inside width	2-2
Order No.:	0621	Inside width	060

**Canopy for chain bracket fixed point inside bend: Type and order number configurator**



Type:	KA 62.1 FB/FG IB	Inside width	2-2
Order No.:	0621	Inside width	058

**Canopy for chain bracket moving end outside bend: Type and order number configurator**



Type:	KA 62.1 FB/FG AB	Inside width	1-2
Order No.:	0621	Inside width	059

**Canopy for chain bracket moving end inside bend: Type and order number configurator**



Type:	KA 62.1 FB/FG IB	Inside width	1-2
Order No.:	0621	Inside width	057

**Ordering example:**

0621096058 KA 62.1 FB/FG IB 118 2-2

Chain bracket canopy at fixing point in inside bend, for inside width of 118 mm.

**RS-ZL-7 CROSSBAR STRAIN RELIEF PLATE**

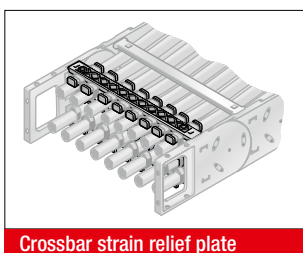

Fixed integrated frame bridge strain relief plates in the chain brackets. Accommodated to all widths of the frame bridges, up to 256 mm in size. May be assembled on the inside and outside flexure curves at both chain endings.

Type	Order No.	Description	Inside width mm
RS-ZL 093-7	072009300010	Crossbar strain relief plate	93.0
RS-ZL 106-7	072010600010	Crossbar strain relief plate	106.0
RS-ZL 118-7	072011800010	Crossbar strain relief plate	118.0
RS-ZL 131-7	072013100010	Crossbar strain relief plate	131.0
RS-ZL 143-7	072014300010	Crossbar strain relief plate	143.0
RS-ZL 156-7	072015600010	Crossbar strain relief plate	156.0
RS-ZL 168-7	072016800010	Crossbar strain relief plate	168.0
RS-ZL 181-7	072018100010	Crossbar strain relief plate	181.0



**RS-ZL-7 CROSSBAR STRAIN RELIEF PLATE**

Type	Order No.	Description	Inside width mm
RS-ZL 193-7	072019300010	Crossbar strain relief plate	193.0
RS-ZL 206-7	072020600010	Crossbar strain relief plate	206.0
RS-ZL 218-7	072021800010	Crossbar strain relief plate	218.0
RS-ZL 231-7	072023100010	Crossbar strain relief plate	231.0
RS-ZL 243-7	072024300010	Crossbar strain relief plate	243.0
RS-ZL 256-7	072025600010	Crossbar strain relief plate	256.0

**STRAIN RELIEF WITH STEEL FIX**

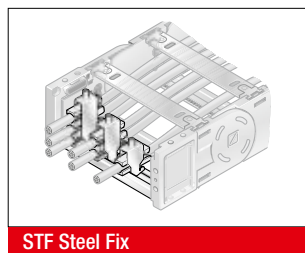
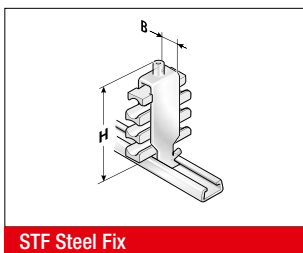

C-rails (galvanised) for permanent integration, for accommodating the Steel Fix bow clamps in the chain brackets. The bow clamps can take up to 3 cables and are suitable for C-rails with a groove width of 11 mm. Due to the design of the trough elements, a cable preserving cable guidance is ensured. May be assembled on the inside and outside bends at both chain endings. The overall height stated is a guide only. The actual height is, amongst other things, dependent on the diameter and the quality of the cable. A safety distance of 10 mm at the fixed point above the strain relief must be kept during gliding applications.

Type	Order No.	Designation	Seats qty.	Cable Ø mm	Width mm	Overall height (H) mm
<b>Single clamp (for one cable)</b>						
STF 12-1 Steel Fix	81661801	Hooped clamp	1	6.0 – 12.0	16.0	55.0
STF 14-1 Steel Fix	81661802	Hooped clamp	1	12.0 – 14.0	18.0	52.0
STF 16-1 Steel Fix	81661803	Hooped clamp	1	14.0 – 16.0	20.0	54.0
STF 18-1 Steel Fix	81661804	Hooped clamp	1	16.0 – 18.0	22.0	56.0
STF 20-1 Steel Fix	81661805	Hooped clamp	1	18.0 – 20.0	24.0	59.0
STF 22-1 Steel Fix	81661806	Hooped clamp	1	20.0 – 22.0	26.0	61.0
STF 26-1 Steel Fix	81661807	Hooped clamp	1	22.0 – 26.0	30.0	70.0
STF 30-1 Steel Fix	81661808	Hooped clamp	1	26.0 – 30.0	34.0	74.0
STF 34-1 Steel Fix	81661809	Hooped clamp	1	30.0 – 34.0	38.0	78.0
STF 38-1 Steel Fix	81661810	Hooped clamp	1	34.0 – 38.0	42.0	82.0
STF 42-1 Steel Fix	81661811	Hooped clamp	1	38.0 – 42.0	46.0	91.0
<b>Double clamp (for two cables)</b>						
STF 12-2 Steel Fix	81661821	Hooped clamp	2	6.0 – 12.0	16.0	73.0
STF 14-2 Steel Fix	81661822	Hooped clamp	2	12.0 – 14.0	18.0	74.0
STF 16-2 Steel Fix	81661823	Hooped clamp	2	14.0 – 16.0	20.0	82.0
STF 18-2 Steel Fix	81661824	Hooped clamp	2	16.0 – 18.0	22.0	86.0
STF 20-2 Steel Fix	81661825	Hooped clamp	2	18.0 – 20.0	24.0	91.0
STF 22-2 Steel Fix	81661826	Hooped clamp	2	20.0 – 22.0	26.0	95.0
STF 26-2 Steel Fix	81661827	Hooped clamp	2	22.0 – 26.0	30.0	108.0
STF 30-2 Steel Fix	81661828	Hooped clamp	2	26.0 – 30.0	34.0	121.0
STF 34-2 Steel Fix	81661829	Hooped clamp	2	30.0 – 34.0	38.0	129.0
<b>Triple clamp (for three cables)</b>						
STF 12-3 Steel Fix	81661841	Hooped clamp	3	6.0 – 12.0	16.0	98.0
STF 14-3 Steel Fix	81661842	Hooped clamp	3	12.0 – 14.0	18.0	98.0
STF 16-3 Steel Fix	81661843	Hooped clamp	3	14.0 – 16.0	20.0	105.0
STF 18-3 Steel Fix	81661844	Hooped clamp	3	16.0 – 18.0	22.0	111.0
STF 20-3 Steel Fix	81661845	Hooped clamp	3	18.0 – 20.0	24.0	118.0
STF 22-3 Steel Fix	81661846	Hooped clamp	3	20.0 – 22.0	26.0	130.0

**LOWERED FIXING POINT MP 62**

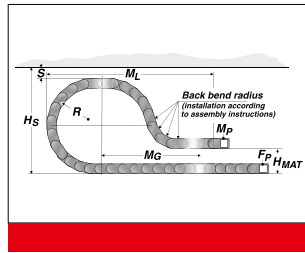
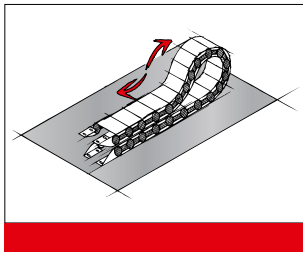

It is sometimes necessary to lower the height of the moving attachment point.

In such cases, modifications to the chain layout should be noted (e.g. extension of chain).

Please contact our application engineers.

Radius R mm	Height of moving end bracket (H <sub>MA</sub> ) mm	Safety margin (S) mm	Installation height incl. safety (H <sub>s</sub> ) mm	Projection (M <sub>1</sub> ) mm	Additional links qty.	of which additional back chain links qty.
200.0	230.0	60.0	564.0	850.0	11	2
250.0	270.0	60.0	664.0	990.0	12	2
300.0	320.0	60.0	764.0	1060.0	12	3
400.0	380.0	90.0	694.0	1060.0	14	3
500.0	440.0	60.0	1164.0	1520.0	17	3

**MP 62.2 REARWARD RADII**

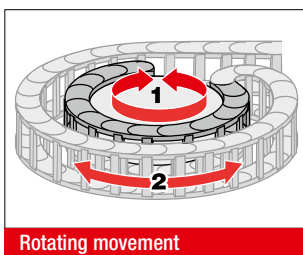

Rotating movement

Side links with rearward radius allow movements in both directions. This is intended for rotating movements and lowered chain brackets. Note: This type of chain has different chain links for the left or right side! Rotation movements are only possible with open variants.

Type	Order No.	Radius mm	Rearward radius mm
SR 62.2 (RÜ300/R300) left	062200030060	300.0	300.0
SR 62.2 (RÜ300/R300) right	062200030062	300.0	300.0

**GUIDE CHANNEL VAW (ALUMINIUM / STAINLESS STEEL)**



VAW steel galvanised / stainless steel



VAW aluminium

A range of variable guide channel systems, constructed from aluminium or stainless steel sections, are available for this energy chain.

The variable guide channel ensures that the energy chain is supported and guided securely.

**ASSEMBLY INSTRUCTION FLEXIBLE CHAIN BRACKET FB/FG**

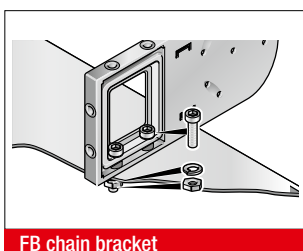

FB chain bracket

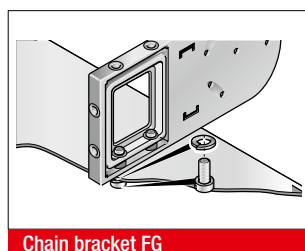

Chain bracket FG

Brass bushes guarantee long-lasting fastening without cold flow in the plastic.

**Version KA-FB:**

Integrated through-hole fastened down using screw and nut.

**Version KA-FG:**

Built-in threads allow for quick and easy on-site mounting, since a screw, including a retaining washer where necessary, is sufficient.

**ASSEMBLY**

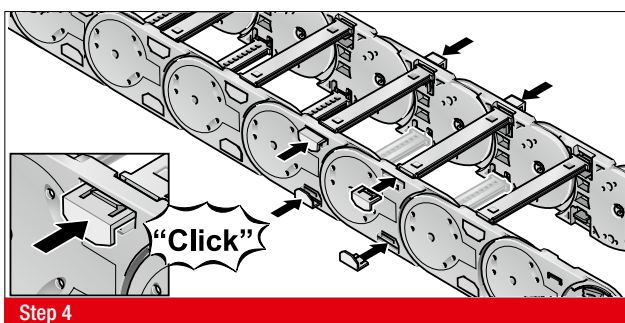
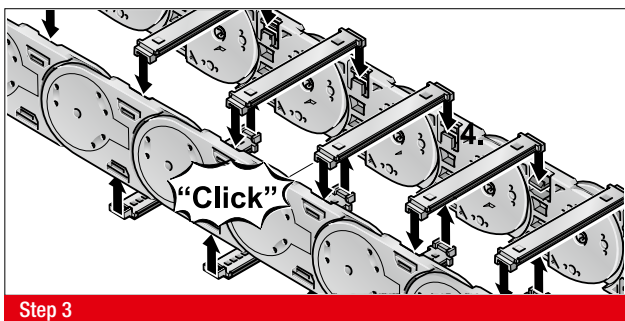
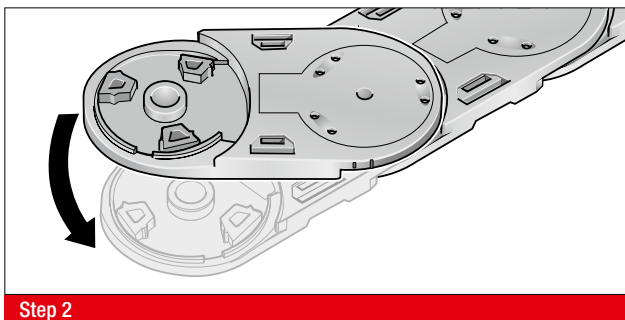
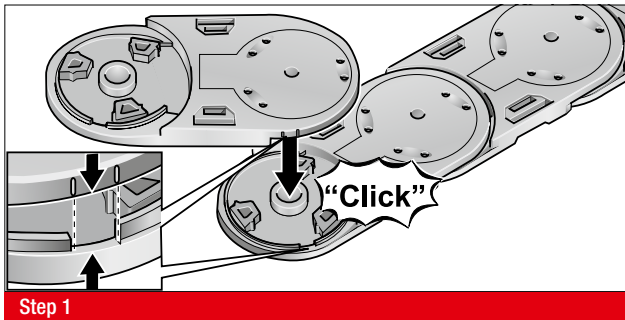

**DISASSEMBLY**

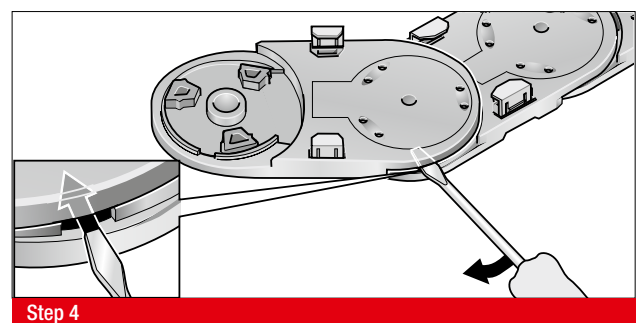
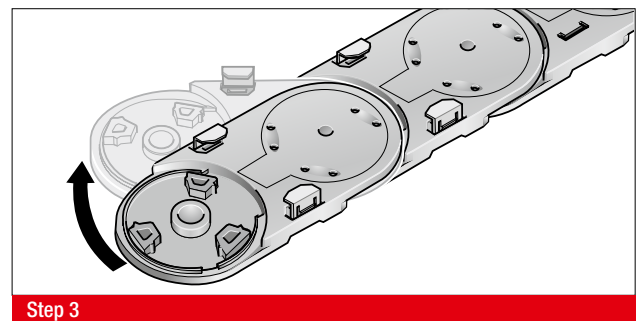
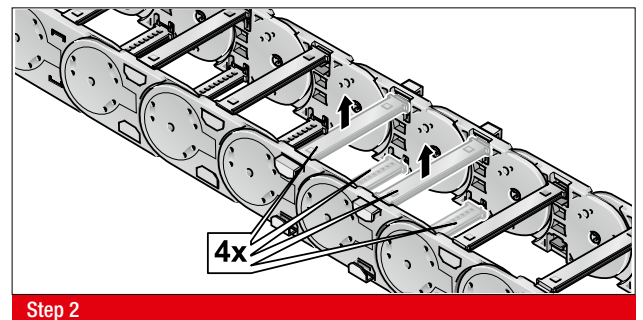
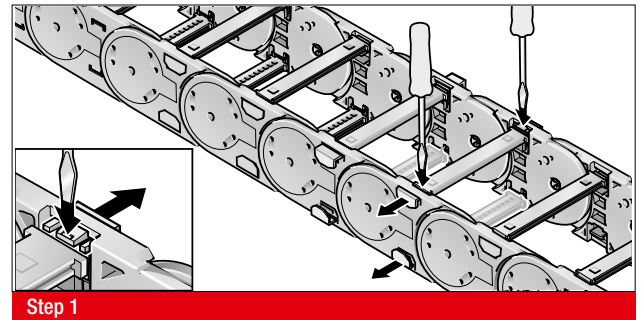

**MP 82.2**  
OPEN

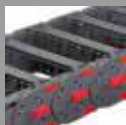

**MP 82.3**  
CLOSED



- SLIDING BLOCKS FOR LONGER SERVICE LIFE
- BROAD INTERIOR LAYOUT
- CHAIN BRACKET FLEXIBLE
- PLASTIC OR ALUMINIUM VERSION
- SIDE LINK LOCK

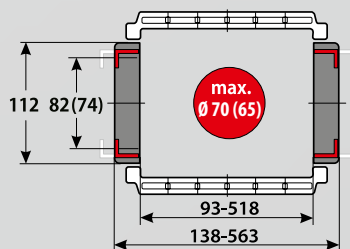

## TECHNICAL DATA

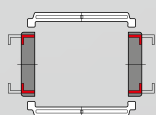

**Loading side**  
Inside and outside bend

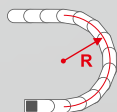

**Available radii**  
150.0 – 650.0 mm

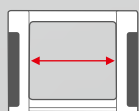

**Available interior widths**  
With plastic crossbar  
93.0 – 518.0 mm  
With alu crossbar / with alu cover  
72.0 – 600.0 mm / 40.0 – 600.0 mm

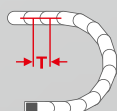

**Pitch**  
T = 118.0 mm

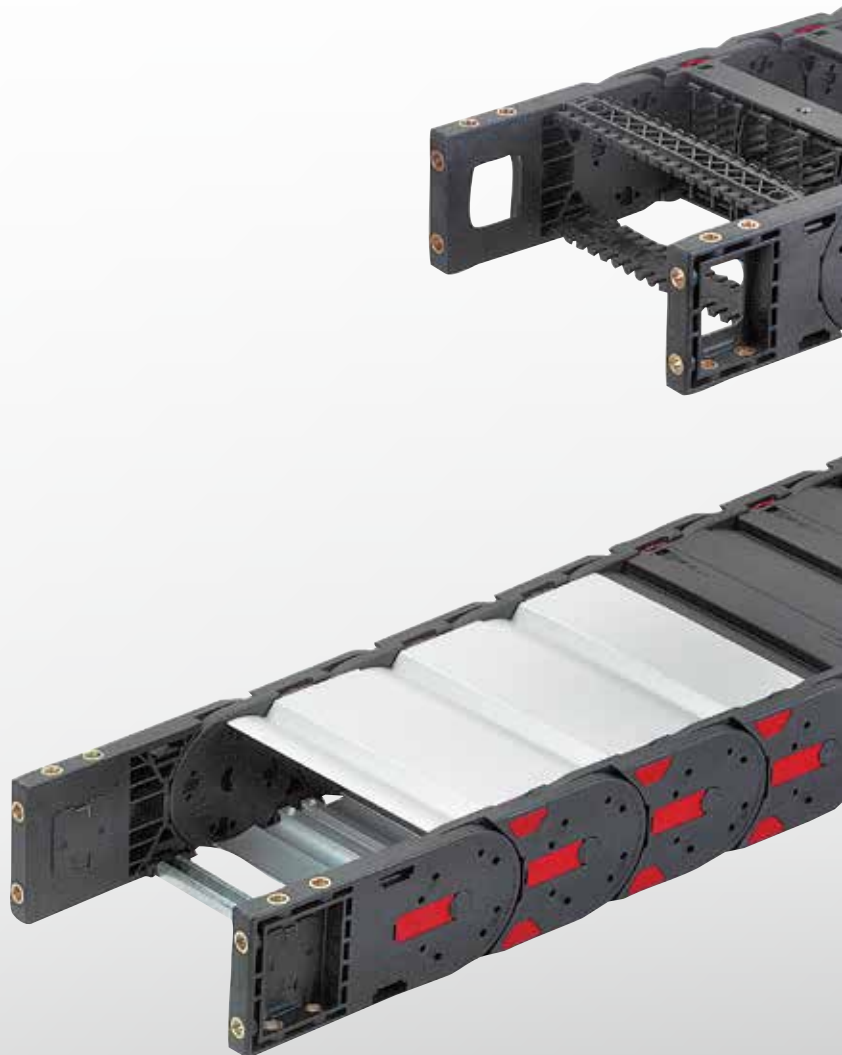



## TECHNICAL SPECIFICATIONS

Travel distance gliding $L_g$ max.	150.0 m
Travel distance self-supporting $L_s$ max.	see diagram on page 307
Travel distance vertical, hanging $L_{vh}$ max.	80.0 m
Travel distance vertical, upright $L_{vs}$ max.	6.0 m
Rotated 90°, unsupported $L_{90f}$ max.	3.0 m
Speed, gliding $V_g$ max.	5.0 m/s
Speed, self-supporting $V_f$ max.	20.0 m/s
Acceleration, gliding $a_g$ max.	25.0 m/s <sup>2</sup>
Acceleration, self-supporting $a_s$ max.	40.0 m/s <sup>2</sup>

Contact our engineering department to meet any higher requirements: [efk@murrplastik.de](mailto:efk@murrplastik.de)

## MATERIAL PROPERTIES

Standard material	Polyamide (PA) black
Service temperature	-30.0 – 120.0 °C
Gliding friction factor	0.3
Static friction factor	0.45
Fire classification	UL 94 HB

Other material properties on request.

## ACCESSORIES



Sliding block

## SHELVING SYSTEM



Separator TR

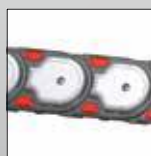

Gliding plate

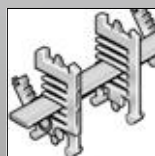

RS shelving system



Bracket bar

## GUIDE CHANNELS



VAW steel galvanised / stainless steel



RS-ZL crossbar strain relief

## CHAIN BRACKET

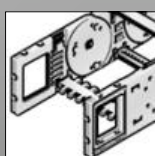

Chain bracket flexible



Crossbar connector RSV



Cover

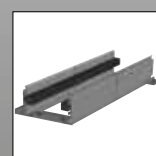

VAW aluminium

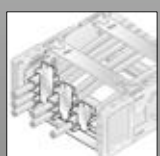

STF Steel Fix

**ORDERING KEY**

Dimensions in mm [US inch]

Type code	Variation	Inside width	Outside width	Inside width	Outside width	Radius	Crossbar variant	Material	Chain length
<b>0822 30</b>	MP 82.2 open Crossbar on outside bend Crossbar on inside bend Opens on inside and outside bend	<b>093</b> [3.66]	<b>138</b> [5.43]	<b>468</b> [18.43]	<b>513</b> [20.20]	<b>150<sup>1)</sup></b> [5.91]	<b>0</b> Plastic, full-ridged with bias	<b>0</b> Polyamide standard (PA/black)	
		<b>106</b> [4.17]	<b>151</b> [5.94]	<b>518</b> [20.39]	<b>563</b> [22.17]				
<b>0823 44<sup>2)</sup></b>	MP 82.3 Closed Cover on outside bend Cover on inside bend Opens on inside and outside bend	<b>118</b> [4.65]	<b>163</b> [6.42]			<b>200</b> [7.87]	<b>1</b> Plastic, full-ridged without bias	<b>5</b> Polypropylene (PP/blue)	
		<b>131</b> [5.16]	<b>176</b> [6.93]						
		<b>143</b> [5.63]	<b>188</b> [7.40]			<b>250</b> [9.84]	<b>2</b> Plastic, half-ridged with bias	<b>7</b> EMC (PA/light grey)	
		<b>156</b> [6.14]	<b>201</b> [7.91]						
		<b>168</b> [6.61]	<b>213</b> [8.39]			<b>300</b> [11.81]	<b>3</b> Plastic, half-ridged without bias	<b>9</b> Special version (on request)	
		<b>181</b> [7.13]	<b>226</b> [8.90]						
		<b>193</b> [7.60]	<b>238</b> [9.37]			<b>350</b> [13.78]	<b>4</b> Aluminium full-ridged with bias		
		<b>206</b> [8.11]	<b>251</b> [9.88]						
		<b>218</b> [8.58]	<b>263</b> [10.35]			<b>400</b> [15.75]	<b>5</b> Aluminium full-ridged without bias		
		<b>231</b> [9.09]	<b>276</b> [10.87]						
		<b>243<sup>3)</sup></b> [9.57]	<b>288</b> [11.34]			<b>500</b> [19.69]	<b>6</b> Aluminium half-ridged with bias		
		<b>256</b> [10.08]	<b>301</b> [11.85]						
		<b>268</b> [10.55]	<b>313</b> [12.32]			<b>650</b> [25.59]	<b>7</b> Aluminium half-ridged without bias		
		<b>293</b> [11.54]	<b>338</b> [13.31]						
		<b>318</b> [12.52]	<b>363</b> [14.29]				<b>9</b> Special version (on request)		
		<b>343</b> [13.50]	<b>388</b> [15.28]						
		<b>368</b> [14.49]	<b>413</b> [16.26]						
		<b>418</b> [16.46]	<b>463</b> [18.23]						

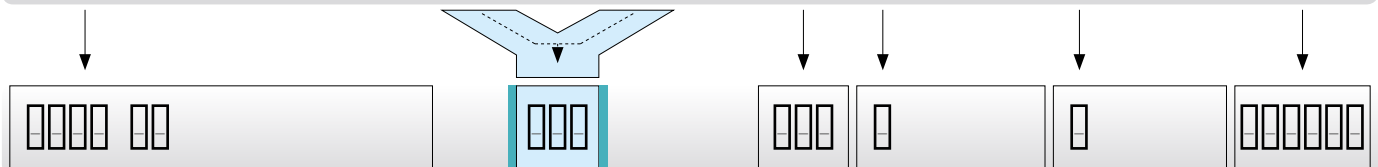

**ORDERING EXAMPLE: 0822 30 118 150 0 0 1534**

Crossbar on outside bend, crossbar on inside bend, can be opened from inside and outside bend  
 Inside width 118 mm; radius 150 mm  
 Plastic crossbar, full-ridged with bias, material black-coloured polyamide  
 Chain length 1534 mm (13 links)

<sup>1)</sup> for Variant 30 only  
<sup>2)</sup> reduced inner height, reduced max. cable diameter, see chain window drawing on previous page  
<sup>3)</sup> also available with plastic cover

**NOTE ON CONFIGURATION**

**Aluminium crossbars:**

Aluminium crossbars can be supplied in 1 mm width sizes for inner widths from 72.0 mm – 600.0 mm .

**Aluminium covers:**

Aluminium covers can be supplied in 1 mm width sizes for inner widths from 40.0 mm – 600.0 mm .

**Crossbar connector and crossbar strain relief plate:**

Once inside widths exceed 243 mm, we recommend the deployment of crossbar connectors (RSV). Crossbar connectors cannot be used in conjunction with covers made from plastic or aluminium.

If crossbar strain relief plates (RS-ZL) are to be deployed in the chain brackets, take standard inside widths into account.

For detailed information, please consult the corresponding product documentation.

**SELF-SUPPORTING LENGTH**

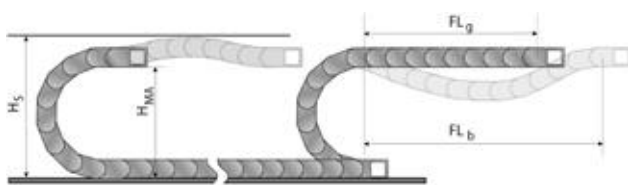

The self-supporting length is the distance between the chain bracket on the moving end and the start of the chain arch. The installation variant  $FL_g$  offers the lowest load and wear for the energy chain. The maximum travel parameters (speed and acceleration) can be applied for this variant.

- $H_s$  = Installation height plus safety
- $H_{MA}$  = Height of moving end connection
- $FL_g$  = Self-supporting length, upper run straight
- $FL_b$  = Self-supporting length, upper run bent

**LOAD DIAGRAM FOR SELF-SUPPORTING APPLICATIONS**

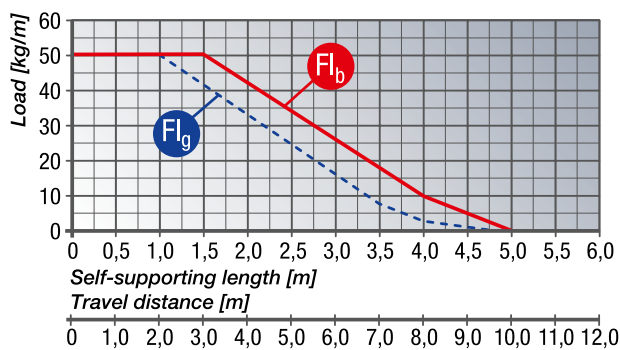

**$FL_g$  Self-supporting length, upper run straight**

In the  $FL_g$  range, the chain upper run still has a bias, is straight or has a maximum sag of 80.0 mm.

**$FL_b$  Self-supporting length, upper run bent**

In the  $FL_b$  range, the chain upper run has a sag of more than 80.0 mm, but this is still less than the maximum sag. Where the sag is greater than that permitted in the  $FL_b$  range, the application is critical and should be avoided. The self-supporting length can be optimised by using a support for the upper run or a more stable energy chain. Closed energy chains (with covers) have a higher unit weight than open chains (with crossbars). This higher weight must be taken into account when calculating the self-supporting length. To the weight of the cabling (cable load, in kg/m), you must add 3.1 kg/m, to account for the higher weight of closed-cover chains.

### DETERMINING THE CHAIN LENGTH

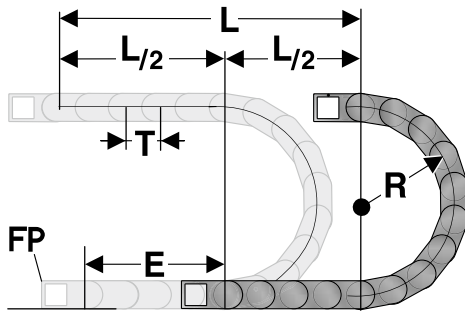

The fixed point of the energy chain should be connected in the middle of the travel distance.

This arrangement gives the shortest connection between the fixed point (FP) and the moving consumer and thus the most efficient chain length.

$$\text{Chain length calculation} = L/2 + \pi * R + E$$

$$\approx 1 \text{ m chain} = 9 \text{ qty.} \times 118.0 \text{ mm.}$$

E = Distance between entry point and middle of travel distance

L = Travel distance

R = Radius

P = Pitch 118.0 mm

### INSTALLATION DIMENSIONS

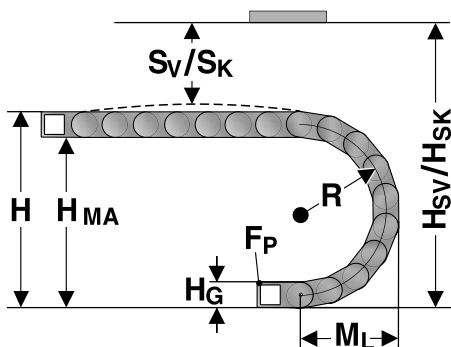

The moving end chain connection is to be screw fixed at height  $H_{MA}$  for the respective radius.

Concerning the installed dimensions, you must take into account whether the chain links are equipped with or without bias.

For chain links without bias, the "Installed height without bias  $H_{SK}$ " value has to be taken into account.

If the chain links are equipped with a bias, the value "Installed height with bias  $H_{SV}$ " has to be taken into account.

Radius R	150	200	250	300	350	400	500	650
Outside height of chain link ( $H_o$ )	112	112	112	112	112	112	112	112
Height of bend (H)	422	522	622	722	822	922	1122	1422
Height of moving end bracket ( $H_{MA}$ )	310	410	510	610	710	810	1010	1310
Safety margin (S)	50	50	50	50	50	50	50	50
Installation height ( $H_s$ )	452	552	652	752	852	952	1152	1452
Safety margin without bias ( $S_R$ )	30	30	30	30	30	30	30	30
Installation height without bias ( $H_{SK}$ )	452	552	652	752	852	952	1152	1452
Arc projection ( $M_L$ )	329	379	429	479	529	579	679	829



## HEAVYLINE PLASTIC CROSSBAR



Crossbar

The crossbars connect the two side runs of the energy chain. The crossbar length is synonymous with the inside width of the energy chain.

Type	Order No.	Description	Inside width mm
RS 093-7	072009300000	Crossbar	93.0
RS 106-7	072010600000	Crossbar	106.0
RS 118-7	072011800000	Crossbar	118.0
RS 131-7	072013100000	Crossbar	131.0
RS 143-7	072014300000	Crossbar	143.0
RS 156-7	072015600000	Crossbar	156.0
RS 168-7	072016800000	Crossbar	168.0
RS 181-7	072018100000	Crossbar	181.0
RS 193-7	072019300000	Crossbar	193.0
RS 206-7	072020600000	Crossbar	206.0
RS 231-7	072023100000	Crossbar	231.0
RS 243-7	072024300000	Crossbar	243.0
RS 256-7	072025600000	Crossbar	256.0
RS 268-7	072026800000	Crossbar	268.0
RS 293-7	072029300000	Crossbar	293.0
RS 318-7	072031800000	Crossbar	318.0
RS 343-7	072034300000	Crossbar	343.0
RS 368-7	072036800000	Crossbar	368.0
RS 418-7	072041800000	Crossbar	418.0
RS 468-7	072046800000	Crossbar	468.0
RS 518-7	072051800000	Crossbar	518.0

## MP 82.3 PLASTIC COVER



Cover

The covers connect the two side runs of the energy chain. The cover length is synonymous with the inside width of the energy chain.

Type	Order No.	Description	Installation site	Inside width mm
A-823243, outside	082324310000	Cover	Outside bend	243.0
I-823243, inside	082324320000	Cover	Inside bend	243.0

**KA 82.2 CHAIN BRACKET FLEXIBLE**

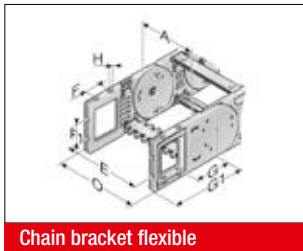

This chain bracket offers universal connection options (top, bottom and front) and is attached to the ends of the chain like a side link. This allows the chain to move right up to the bracket. Each chain requires one male and one female bracket. M8 screws are used to secure the brackets in place. Pressed-in metal bushes with a through-hole ensure the permanent, high-strength transmission of even extreme forces onto the energy chain.

Type	Order No.	Material	Version	Inside width								Outside width of KA O mm
				A mm	E mm	F mm	F1 mm	G mm	G1 mm	H mm	H0 mm	
KA 82-FB Female end	0820000056	Plastic	with bush	93.0 – 518.0	A+23.0	35.0	66.0	117.0	182.0	11.0	A+45.0	
KA 82-FB male end	0820000057	Plastic	with bush	93.0 – 518.0	A+23.0	35.0	66.0	117.0	182.0	11.0	A+45.0	
KA 82-FG Female end	0820000058	Plastic	with thread	93.0 – 518.0	A+23.0	35.0	66.0	117.0	182.0	M10	A+45.0	
KA 82-FG male end	0820000059	Plastic	with thread	93.0 – 518.0	A+23.0	35.0	66.0	117.0	182.0	M10	A+45.0	

**MP 82.2 SLIDING BLOCK**

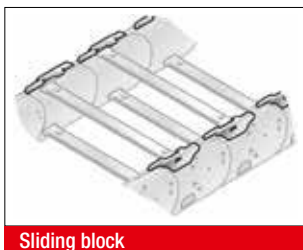

In the case of energy chains, sliding blocks are used in a horizontally sliding installation mode (the tight side of the chain slides on the slack side). The sliding blocks are set onto the side links on the interior bend instead of the usual crossbar interlocks; (no tools needed). This forces the chain to slide on the sliding blocks instead on the side links of the chain. Depending on the application, the service life of the energy chain may be extended five-fold, by using slide blocks. Information about the minimum bending radius of the energy chain at the sliding block insert is listed in the following table.

Type	Order No.	Installation site	Min. radius mm	Sliding block height mm
GS 82.2.1 right	082290400302	For right side link	200.0	6.0
GS 82.2.2 left	082290400300	For left side link	200.0	6.0

**GLP 8 (82.2) GLIDING PLATE**



The gliding plates are mounted in a horizontal position, with the chain laying on its side, to minimize friction wear to the sides. The gliding plates are placed onto the side links instead of the usual chain link side locks (no tools required). The wear limit is 2.5 mm. We recommend replacing the energy chain when this limit has been reached. Depending on the application, the service life of the energy chain may be extended two-fold, by using gliding plates. The energy chain must be placed on its side before opening.

Type	Order No.	Installation site	Gliding plate height mm
GLP 8	082290400301	GLP8 gliding plate for the MP82.2, MP82.3	7.0

**TR 82 SEPARATOR**

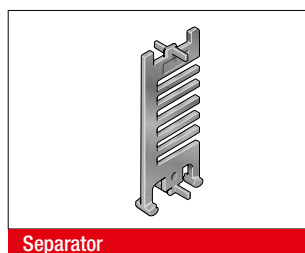
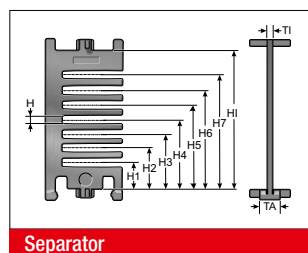

We recommend that separators be used if multiple round cables or conduits with differing diameters are to be installed.

Type	Order No.	Description	Version	TI mm	TA mm	H mm	H1 mm	H2 mm	H3 mm	H4 mm	H5 mm	H6 mm	H7 mm	HI mm
TR 82-S	082000009300	Separator	lockable	4.0	14.8	5.5	23.1	39.7	56.3					82.0
TR 82	082000009200	Separator	lockable	3.5	15.0	5.5	14.9	23.2	31.5	39.8	48.1	56.4	64.7	82.0

**RTT 82 SHELF SUPPORT, DIVISIBLE**

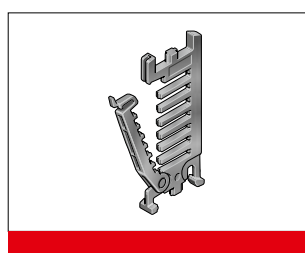
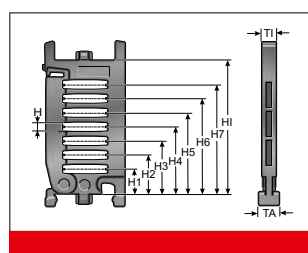

In connection with two separable shelf supports (RTT) with at least one end-to-end shelf (RB) the shelf becomes an easy to fill shelving system. The additional levels prevent cables from criss-crossing and minimise the friction between them.

Type	Order No.	Description	Version	TI mm	TA mm	H mm	H1 mm	H2 mm	H3 mm	H4 mm	H5 mm	H6 mm	H7 mm	HI mm
RTT 82	100090822000	Shelf support, divisible	lockable	8.0	8.0	5.5	14.9	23.2	31.5	39.8	48.1	56.4	64.7	82.0

**RSV 82.2 CROSSBAR CONNECTOR**



For crossbars wider than 246 mm, we recommend the use of crossbar connectors. These prevent deformation to the crossbar under large amounts of additional weight of the chain assembly.

Type	Order No.	Description	TI mm
RSV 82	082000009600	Crossbar connector	8.0
RSV 82 Alu	082000009800	Crossbar connector for aluminium crossbars	8.0

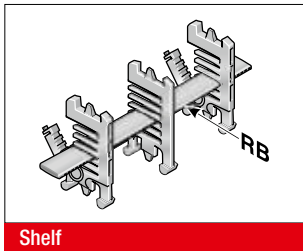
**RB-7 SHELF**

In connection with at least two separable shelf supports (RTT), the shelf becomes a shelving system. The additional levels prevent cables from criss-crossing and minimise the friction between them.

Type	Order No.	Description	Width mm	Inside width mm
RB 056-7	100000005600	Shelf	56.0	93.0
RB 061-7	1000006107	Shelf	61.0	93.0
RB 066-7	100000006600	Shelf	66.0	93.0
RB 071-7	1000007107	Shelf	71.0	93.0
RB 076-7	1000007607	Shelf	76.0	93.0
RB 081-7	100000008100	Shelf	81.0	93.0
RB 086-7	1000008607	Shelf	86.0	93.0
RB 091-7	1000009107	Shelf	91.0	106.0
RB 096-7	1000009607	Shelf	96.0	106.0
RB 101-7	1000010107	Shelf	101.0	106.0
RB 106-7	100000010600	Shelf	106.0	106.0
RB 111-7	1000011107	Shelf	111.0	118.0
RB 116-7	100000011600	Shelf	116.0	118.0
RB 121-7	1000012107	Shelf	121.0	131.0
RB 126-7	1000012607	Shelf	126.0	131.0
RB 131-7	1000013107	Shelf	131.0	143.0
RB 136-7	1000013607	Shelf	136.0	143.0
RB 141-7	1000014107	Shelf	141.0	143.0
RB 146-7	1000014607	Shelf	146.0	156.0
RB 151-7	1000015107	Shelf	151.0	156.0
RB 156-7	1000015607	Shelf	156.0	156.0
RB 161-7	1000016107	Shelf	161.0	168.0
RB 166-7	100000016600	Shelf	166.0	168.0
RB 171-7	1000017107	Shelf	171.0	181.0
RB 176-7	1000017607	Shelf	176.0	181.0
RB 181-7	1000018107	Shelf	181.0	193.0
RB 186-7	1000018607	Shelf	186.0	193.0
RB 191-7	1000019107	Shelf	191.0	193.0
RB 196-7	1000019607	Shelf	196.0	206.0
RB 201-7	1000020107	Shelf	201.0	206.0
RB 206-7	1000020607	Shelf	206.0	206.0
RB 211-7	1000021107	Shelf	211.0	218.0
RB 216-7	100000021600	Shelf	216.0	218.0

**BS-5 BRACKET BAR**



Large-diameter conduits are routed securely by using a bracket bar (BS). This bar is installed on the crossbars or the covers of the energy chain.

The bracket bar can be installed on both the inside and outside bend.

The bracket bar support (BSH) is used to attach the bars to PowerLine series crossbars. Two bracket bar supports are required for each bar.

Type	Order No.	Description	Conduit diameter max. mm	Installation height mm	Inner chain width min. mm
BS 120-5	052412000000	Bracket bar	115.0	140.0	164.0
BS 153-5	052415300000	Bracket bar	148.0	170.0	208.0
BS 187-5	052418700000	Bracket bar	182.0	205.0	233.0
Assembly set	052400000001	Assembly set			

**D8 CHAIN BRACKET COVER**



Self-locking covers close the side mounting window on the flexible chain bracket (KA-FB/FG).

Type	Order No.
Cover D8 KA 82.1 -FB/FG	0823888002

**MP 82.3 CHAIN BRACKET CANOPY**



Constructed from aluminium, the canopies for the flexible chain bracket (KA-FB/FG) ensure a continuously closed system for chains with covers.

**MP 82.3 CHAIN BRACKET CANOPY**

Canopy for: chain bracket, fixed point outside bend: Type and order number configurator



Type:	KA 82.1 FB/FG AB	Inside width	2-2
Order no.:	0821	Inside width	060

Cover for: Bracket fixed point inside bend: Type and order number configurator

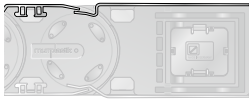

Type:	KA 82.1 FB/FG IB	Inside width	2-2
Order no.:	0821	Inside width	058

Cover for: Bracket moving end outside bend: Type and order number configurator

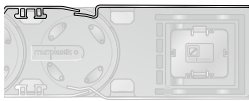

Type:	KA 82.1 FB/FG AB	Inside width	1-2
Order no.:	0821	Inside width	059

Cover for: Bracket moving end inside bend: Type and order number configurator



Type:	KA 82.1 FB/FG IB	Inside width	1-2
Order no.:	0821	Inside width	057

**Ordering example:**

0821118058 KA 82.1 FB/FG IB 118 2-2

Chain bracket canopy at fixing point in inside bend, for inside width of 118 mm.

**RS-ZL-7 CROSSBAR STRAIN RELIEF PLATE**

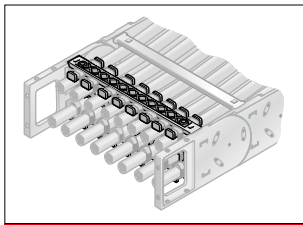

Crossbar strain relief plate

Fixed integrated frame bridge strain relief plates in the chain brackets. Accommodated to all widths of the frame bridges, up to 256 mm in size. May be assembled on the inside and outside flexure curves at both chain endings.

Type	Order No.	Description	Inside width mm
RS-ZL 093-7	072009300010	Crossbar strain relief plate	93.0
RS-ZL 106-7	072010600010	Crossbar strain relief plate	106.0
RS-ZL 118-7	072011800010	Crossbar strain relief plate	118.0
RS-ZL 131-7	072013100010	Crossbar strain relief plate	131.0
RS-ZL 143-7	072014300010	Crossbar strain relief plate	143.0
RS-ZL 156-7	072015600010	Crossbar strain relief plate	156.0
RS-ZL 168-7	072016800010	Crossbar strain relief plate	168.0
RS-ZL 181-7	072018100010	Crossbar strain relief plate	181.0
RS-ZL 193-7	072019300010	Crossbar strain relief plate	193.0
RS-ZL 206-7	072020600010	Crossbar strain relief plate	206.0
RS-ZL 218-7	072021800010	Crossbar strain relief plate	218.0
RS-ZL 231-7	072023100010	Crossbar strain relief plate	231.0
RS-ZL 243-7	072024300010	Crossbar strain relief plate	243.0
RS-ZL 256-7	072025600010	Crossbar strain relief plate	256.0

**STRAIN RELIEF WITH STEEL FIX**

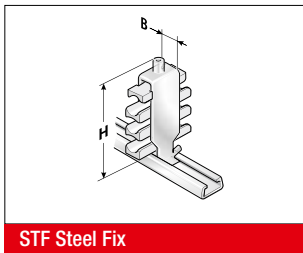

STF Steel Fix

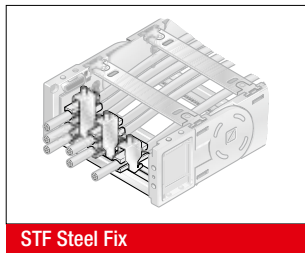

STF Steel Fix

C-rails (galvanised) for permanent integration, for accommodating the Steel Fix bow clamps in the chain brackets. The bow clamps can take up to 3 cables and are suitable for C-rails with a groove width of 11 mm. Due to the design of the trough elements, a cable preserving cable guidance is ensured. May be assembled on the inside and outside bends at both chain endings. The overall height stated is a guide only. The actual height is, amongst other things, dependent on the diameter and the quality of the cable. A safety distance of 10 mm at the fixed point above the strain relief must be kept during gliding applications.

Type	Order No.	Description	Seats qty.	Cable Ø mm	Width mm	Total height (H) mm
<b>Single clamp (for one cable)</b>						
STF 12-1 Steel Fix	81661801	Hooped clamp	1	6.0 – 12.0	16.0	55.0
STF 14-1 Steel Fix	81661802	Hooped clamp	1	12.0 – 14.0	18.0	52.0
STF 16-1 Steel Fix	81661803	Hooped clamp	1	14.0 – 16.0	20.0	54.0
STF 18-1 Steel Fix	81661804	Hooped clamp	1	16.0 – 18.0	22.0	56.0
STF 20-1 Steel Fix	81661805	Hooped clamp	1	18.0 – 20.0	24.0	59.0
STF 22-1 Steel Fix	81661806	Hooped clamp	1	20.0 – 22.0	26.0	61.0
STF 26-1 Steel Fix	81661807	Hooped clamp	1	22.0 – 26.0	30.0	70.0
STF 30-1 Steel Fix	81661808	Hooped clamp	1	26.0 – 30.0	34.0	74.0
STF 34-1 Steel Fix	81661809	Hooped clamp	1	30.0 – 34.0	38.0	78.0
STF 38-1 Steel Fix	81661810	Hooped clamp	1	34.0 – 38.0	42.0	82.0
STF 42-1 Steel Fix	81661811	Hooped clamp	1	38.0 – 42.0	46.0	91.0
<b>Double clamp (for two cables)</b>						
STF 12-2 Steel Fix	81661821	Hooped clamp	2	6.0 – 12.0	16.0	73.0
STF 14-2 Steel Fix	81661822	Hooped clamp	2	12.0 – 14.0	18.0	74.0
STF 16-2 Steel Fix	81661823	Hooped clamp	2	14.0 – 16.0	20.0	82.0
STF 18-2 Steel Fix	81661824	Hooped clamp	2	16.0 – 18.0	22.0	86.0
STF 20-2 Steel Fix	81661825	Hooped clamp	2	18.0 – 20.0	24.0	91.0
STF 22-2 Steel Fix	81661826	Hooped clamp	2	20.0 – 22.0	26.0	95.0
STF 26-2 Steel Fix	81661827	Hooped clamp	2	22.0 – 26.0	30.0	108.0
STF 30-2 Steel Fix	81661828	Hooped clamp	2	26.0 – 30.0	34.0	121.0
STF 34-2 Steel Fix	81661829	Hooped clamp	2	30.0 – 34.0	38.0	129.0
<b>Triple clamp (for three cables)</b>						
STF 12-3 Steel Fix	81661841	Hooped clamp	3	6.0 – 12.0	16.0	98.0
STF 14-3 Steel Fix	81661842	Hooped clamp	3	12.0 – 14.0	18.0	98.0
STF 16-3 Steel Fix	81661843	Hooped clamp	3	14.0 – 16.0	20.0	105.0
STF 18-3 Steel Fix	81661844	Hooped clamp	3	16.0 – 18.0	22.0	111.0
STF 20-3 Steel Fix	81661845	Hooped clamp	3	18.0 – 20.0	24.0	118.0
STF 22-3 Steel Fix	81661846	Hooped clamp	3	20.0 – 22.0	26.0	130.0

**MP 82.2 LOWERED FIXING POINT**

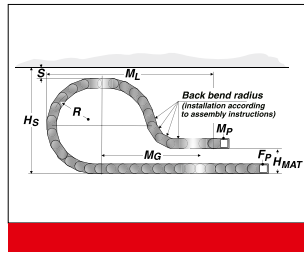
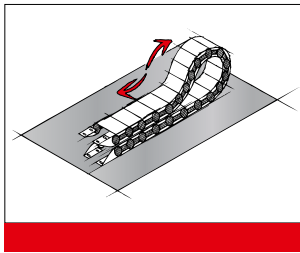

It is sometimes necessary to lower the height of the moving attachment point.

In such cases, modifications to the chain layout should be noted (e.g. extension of chain).

Please contact our application engineers.

Radius R mm	Height of moving end bracket (H <sub>MA</sub> ) mm	Safety margin (S) mm	Installation height incl. safety (H <sub>S</sub> ) mm	Projection (M <sub>L</sub> ) mm	Additional links qty.	of which additional back chain links qty.
200.0	240.0	60.0	582.0	900.0	8	2
250.0	260.0	60.0	682.0	1050.0	10	2
300.0	290.0	60.0	782.0	1130.0	11	2
350.0	330.0	60.0	942.0	1250.0	12	2
400.0	420.0	60.0	982.0	1340.0	13	2
500.0	400.0	60.0	1182.0	1620.0	16	4

**MP 82.2 REARWARD RADII**

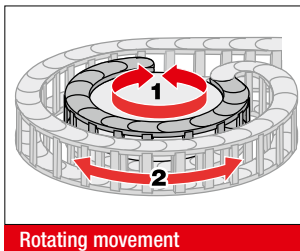

Rotating movement

Side links with rearward radius allow movements in both directions. This is intended for rotating movements and lowered chain brackets. Note: This type of chain has different chain links for the left or right side! Rotation movements are only possible with open variants.

Type	Order No	Radius mm	Rearward radius mm
SR 82.2 (RÜ300/R300) left	082200030060	300.0	300.0
SR 82.2 (RÜ300/R300) right	082200030062	300.0	300.0

**GUIDE CHANNEL VAW (ALUMINIUM / STAINLESS STEEL)**



VAW steel galvanised / stainless steel



VAW aluminium

A range of variable guide channel systems, constructed from aluminium or stainless steel sections, are available for this energy chain. The variable guide channel ensures that the energy chain is supported and guided securely.

**ASSEMBLY INSTRUCTION FLEXIBLE CHAIN BRACKET FB/FG**

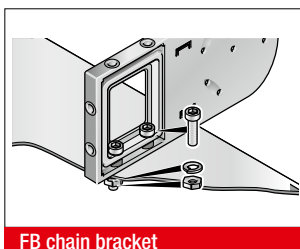

FB chain bracket

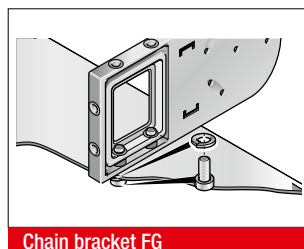

Chain bracket FG

Brass bushes guarantee long-lasting fastening without cold flow in the plastic.

**Version KA-FB:**

Integrated through-hole fastened down using screw and nut.

**Version KA-FG:**

Built-in threads allow for quick and easy on-site mounting, since a screw, including a retaining washer where necessary, is sufficient.



**ASSEMBLY**

**DISASSEMBLY**

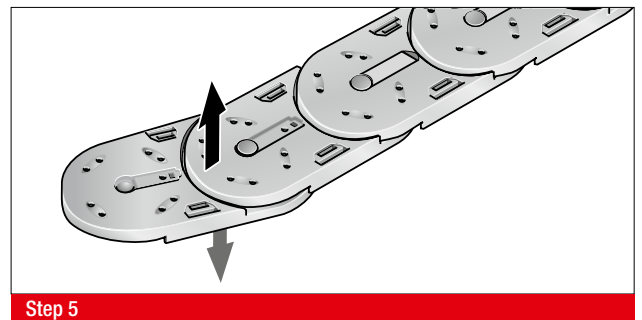
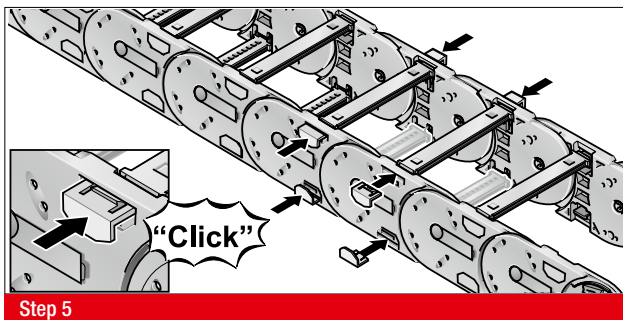
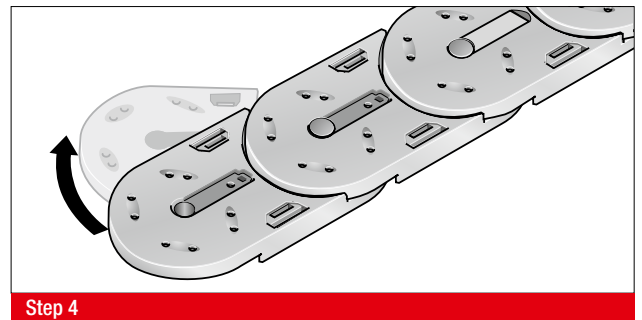
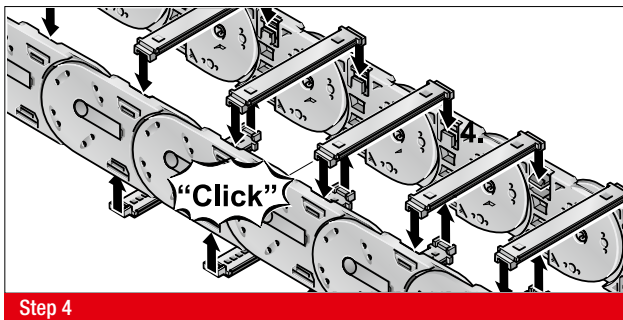
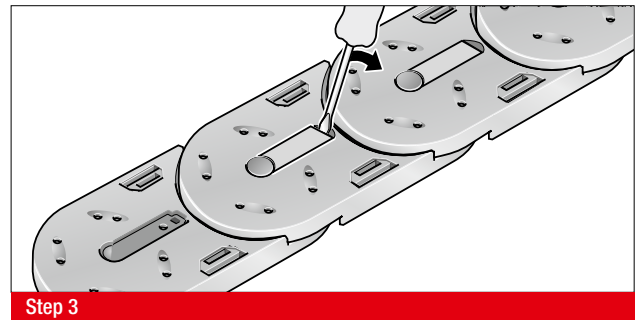
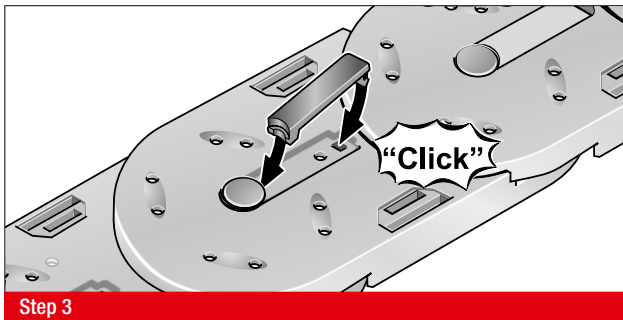
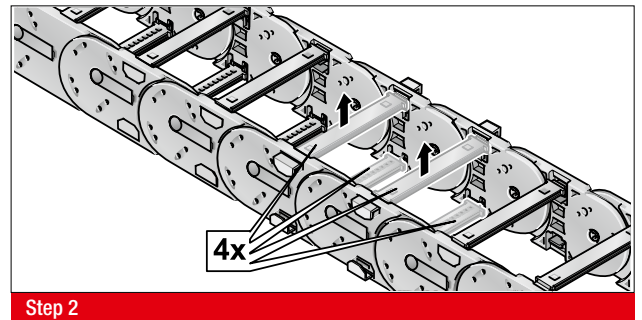
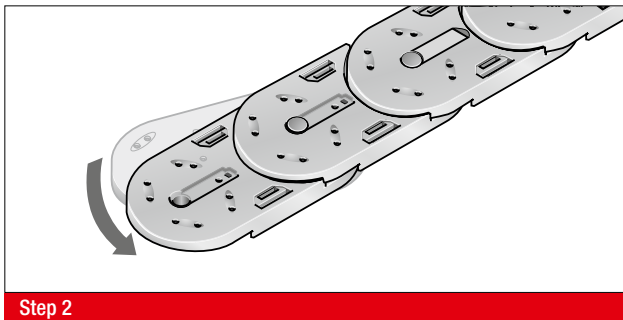
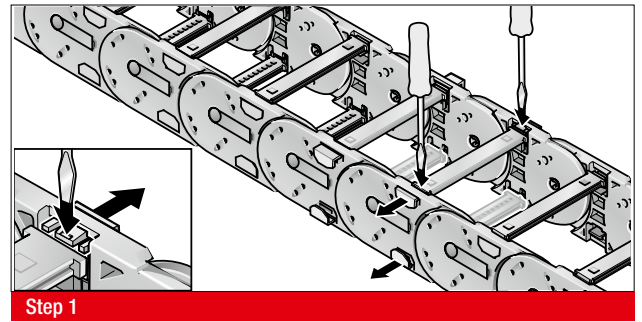
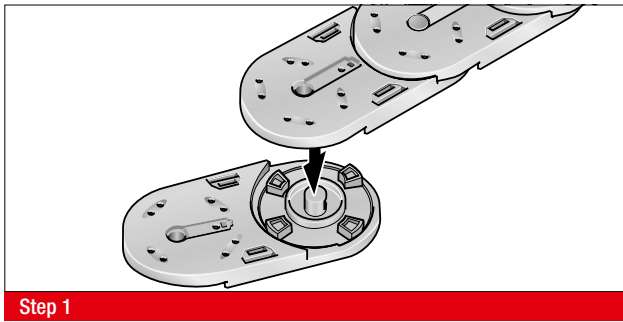

## MP 102.2 OPEN

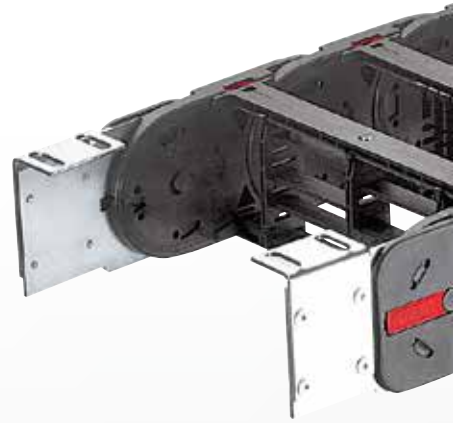

- BROAD INTERIOR LAYOUT
- STEEL ANGLE CHAIN BRACKET
- PLASTIC OR ALUMINIUM VERSION
- SIDE LINK LOCK

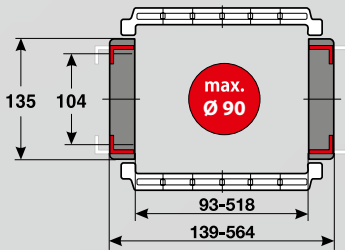

### TECHNICAL DATA

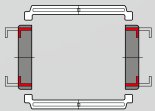

**Loading side**  
Inside and outside bend

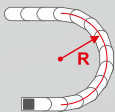

**Available radii**  
250.0 – 500.0 mm

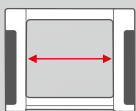

**Available interior widths**  
With plastic crossbar  
93.0 – 518.0 mm  
With alu crossbar / with alu cover  
72.0 – 600.0 mm /

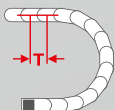

**Pitch**  
T = 141.0 mm

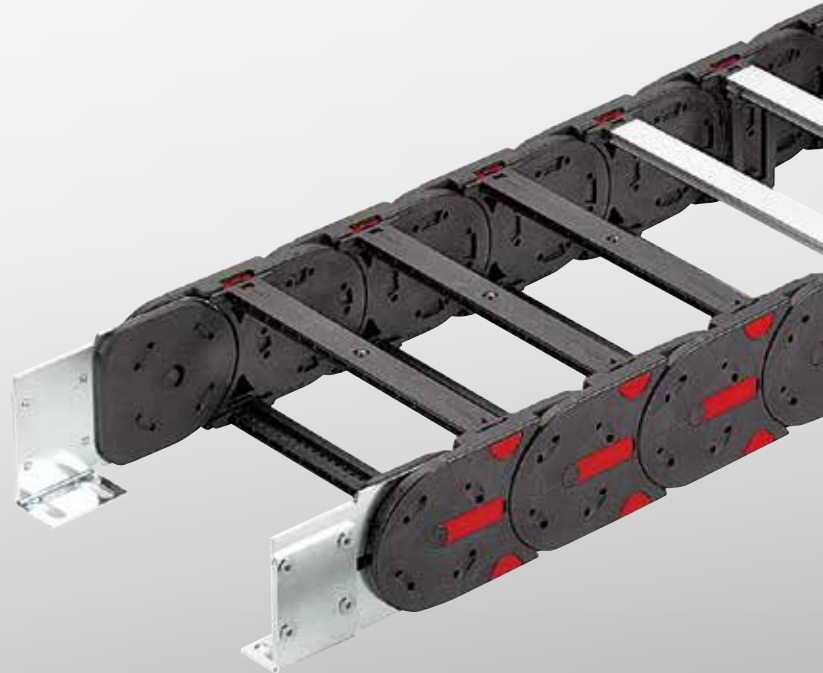



## TECHNICAL SPECIFICATIONS

Travel distance gliding $L_g$ max.	150.0 m
Travel distance self-supporting $L_s$ max.	see diagram on page 321
Travel distance vertical, hanging $L_{vh}$ max.	80.0 m
Travel distance vertical, upright $L_{vs}$ max.	8.0 m
Rotated 90°, unsupported $L_{90f}$ max.	8.0 m
Speed, gliding $V_g$ max.	5.0 m/s
Speed, self-supporting $V_f$ max.	20.0 m/s
Acceleration, gliding $a_g$ max.	25.0 m/s <sup>2</sup>
Acceleration, self-supporting $a_s$ max.	40.0 m/s <sup>2</sup>

Contact our engineering department to meet any higher requirements: [efk@murrplastik.de](mailto:efk@murrplastik.de)

## MATERIAL PROPERTIES

Standard material	Polyamide (PA) black
Service temperature	-30.0 – 120.0 °C
Gliding friction factor	0.3
Static friction factor	0.45
Fire classification	UL 94 HB

Other material properties on request.

## SHELVING SYSTEM



Separator TR

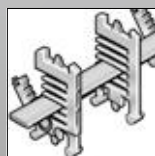

RS shelving system

## CHAIN BRACKET

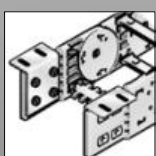

Chain bracket angle



Crossbar connector RSV

## ACCESSORIES

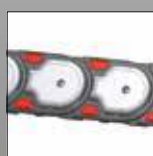

Gliding plate

## GUIDE CHANNELS

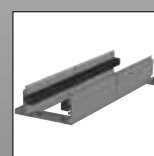

VAW aluminium

## STRAIN RELIEF



RS-ZL crossbar strain relief



STF Steel Fix

**ORDERING KEY**

Dimensions in mm [US inch]

Type code	Variation	Inside width	Outside width	Inside width	Outside width	Radius	Crossbar variant	Material	Chain length
<b>1022 30</b>	Crossbar on outside bend Crossbar on inside bend Opens on inside and outside bend	<b>093</b> [3.66]	<b>139</b> [5.47]	<b>468</b> [18.43]	<b>514</b> [20.24]	<b>250</b> [9.84]	<b>0</b> Plastic, full-ridged with bias	<b>0</b> Polyamide standard (PA/black)	
		<b>106</b> [4.17]	<b>152</b> [5.98]	<b>518</b> [20.39]	<b>564</b> [22.20]				
		<b>118</b> [4.65]	<b>164</b> [6.46]			<b>300</b> [11.81]	<b>2</b> Plastic, half-ridged with bias	<b>9</b> Special version (on request)	
		<b>131</b> [5.16]	<b>177</b> [6.97]						
		<b>143</b> [5.63]	<b>189</b> [7.44]			<b>400</b> [15.75]	<b>4</b> Aluminium full-ridged with bias		
		<b>156</b> [6.14]	<b>202</b> [7.95]						
		<b>168</b> [6.61]	<b>214</b> [8.43]			<b>500</b> [19.69]	<b>6</b> Aluminium half-ridged with bias		
		<b>181</b> [7.13]	<b>227</b> [8.94]						
		<b>193</b> [7.60]	<b>239</b> [9.41]				<b>9</b> Special version (on request)		
		<b>206</b> [8.11]	<b>252</b> [9.92]						
		<b>218</b> [8.58]	<b>264</b> [10.39]						
		<b>231</b> [9.09]	<b>277</b> [10.91]						
		<b>243</b> [9.57]	<b>289</b> [11.38]						
		<b>256</b> [10.08]	<b>302</b> [11.89]						
		<b>268</b> [10.55]	<b>314</b> [12.36]						
		<b>293</b> [11.54]	<b>339</b> [13.35]						
		<b>318</b> [12.52]	<b>364</b> [14.33]						
		<b>343</b> [13.50]	<b>389</b> [15.31]						
		<b>368</b> [14.49]	<b>414</b> [16.30]						
		<b>418</b> [16.46]	<b>464</b> [18.27]						

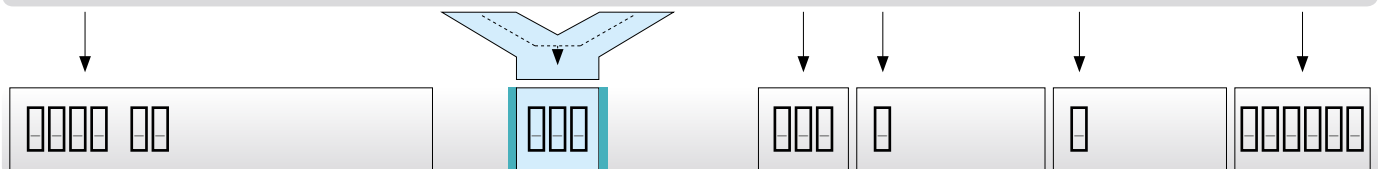

**ORDERING EXAMPLE: 1022 30 118 250 0 0 1974**

Crossbar on outside bend, crossbar on inside bend, can be opened from inside and outside bend  
 Inside width 118 mm; radius 250 mm  
 Plastic crossbar, full-ridged with bias, material black-coloured polyamide  
 Chain length 1974 mm (14 links)

**NOTE ON CONFIGURATION**

**Aluminium crossbars:**

Aluminium crossbars can be supplied in 1 mm width sizes for inner widths from 67.0 mm – 600.0 mm.

**Crossbar strain relief plate:**

If crossbar strain relief plates (RS-ZL) are to be deployed in the chain brackets, take standard inside widths into account.

For detailed information, please consult the corresponding product documentation.

**SELF-SUPPORTING LENGTH**

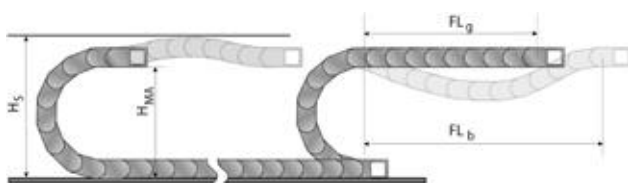

The self-supporting length is the distance between the chain bracket on the moving end and the start of the chain arch. The installation variant  $FL_g$  offers the lowest load and wear for the energy chain. The maximum travel parameters (speed and acceleration) can be applied for this variant.

- $H_s$  = Installation height plus safety
- $H_{MA}$  = Height of moving end connection
- $FL_g$  = Self-supporting length, upper run straight
- $FL_b$  = Self-supporting length, upper run bent

**LOAD DIAGRAM FOR SELF-SUPPORTING APPLICATIONS**

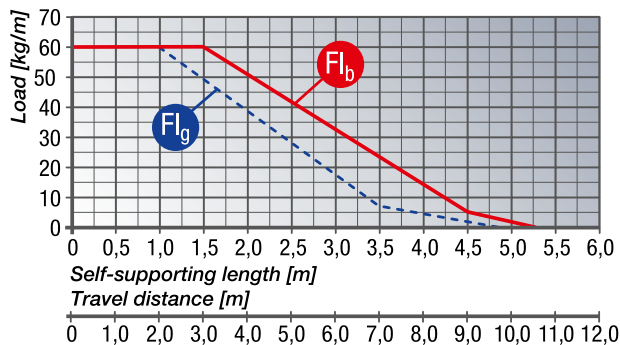

**$FL_g$  Self-supporting length, upper run straight**

In the  $FL_g$  range, the chain upper run still has a bias, is straight or has a maximum sag of 80.0 mm.

**$FL_b$  Self-supporting length, upper run bent**

In the  $FL_b$  range, the chain upper run has a sag of more than 80.0 mm, but this is still less than the maximum sag. Where the sag is greater than that permitted in the  $FL_b$  range, the application is critical and should be avoided. The self-supporting length can be optimised by using a support for the upper run or a more stable energy chain.

**DETERMINING THE CHAIN LENGTH**

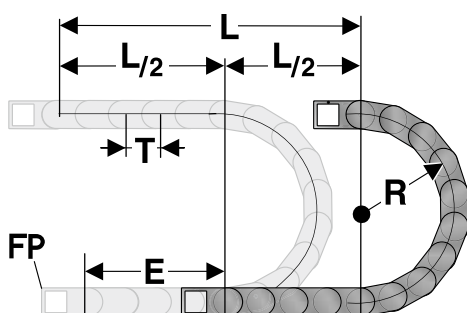

The fixed point of the energy chain should be connected in the middle of the travel distance.

This arrangement gives the shortest connection between the fixed point (FP) and the moving consumer and thus the most efficient chain length.

$$\text{Chain length calculation} = L/2 + \pi * R + E$$

$$\approx 1 \text{ m chain} = 7 \text{ qty. } \times 141.0 \text{ mm.}$$

- E = Distance between entry point and middle of travel distance
- L = Travel distance
- R = Radius
- P = Pitch 141.0 mm

**INSTALLATION DIMENSIONS**

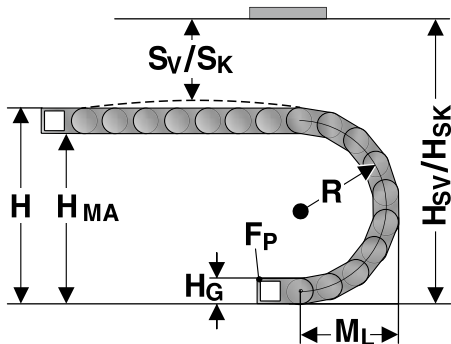

The moving end chain connection is to be screw fixed at height  $H_{MA}$  for the respective radius.  
For the installed dimension the “Installed height  $H_s$ ” value has to be taken into account.

Radius R	250	300	400	500
Outside height of chain link ( $H_o$ )	135	135	135	135
Height of bend (H)	655	755	955	1155
Height of moving end bracket ( $H_{MA}$ )	520	620	820	1020
Installation height ( $H_g$ )	705	805	1005	1205
Safety margin without bias ( $S_k$ )	50	50	50	50
Installation height without bias ( $H_{SK}$ )	705	805	1005	1205
Arc projection ( $M_l$ )	469	519	619	719

**HEAVYLINE PLASTIC CROSSBAR**



The crossbars connect the two side runs of the energy chain.  
The crossbar length is synonymous with the inside width of the energy chain.

Type	Order No.	Description	Inside width mm
RS 093-7	072009300000	Crossbar	93.0
RS 106-7	072010600000	Crossbar	106.0
RS 118-7	072011800000	Crossbar	118.0
RS 131-7	072013100000	Crossbar	131.0
RS 143-7	072014300000	Crossbar	143.0
RS 156-7	072015600000	Crossbar	156.0
RS 168-7	072016800000	Crossbar	168.0
RS 181-7	072018100000	Crossbar	181.0
RS 193-7	072019300000	Crossbar	193.0
RS 206-7	072020600000	Crossbar	206.0
RS 231-7	072023100000	Crossbar	231.0
RS 243-7	072024300000	Crossbar	243.0
RS 256-7	072025600000	Crossbar	256.0
RS 268-7	072026800000	Crossbar	268.0
RS 293-7	072029300000	Crossbar	293.0
RS 318-7	072031800000	Crossbar	318.0
RS 343-7	072034300000	Crossbar	343.0

**HEAVYLINE PLASTIC CROSSBAR**

Type	Order No.	Description	Inside width mm
RS 368-7	072036800000	Crossbar	368.0
RS 418-7	072041800000	Crossbar	418.0
RS 468-7	072046800000	Crossbar	468.0
RS 518-7	072051800000	Crossbar	518.0

**KA 102 CHAIN BRACKET ANGLE**

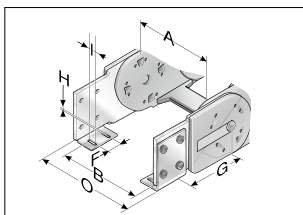

KA 102 (inside up / down)

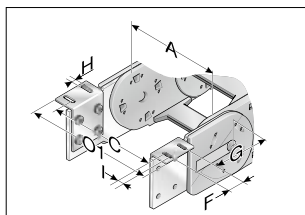

KA 102 (outside up / down)

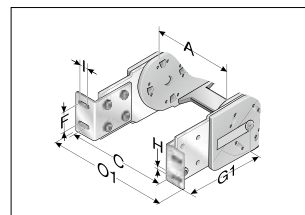

KA 102 (front outside)

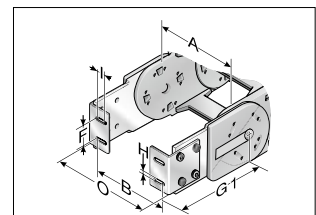

KA 102 (front side internal)

There are several options regarding the chain bracket. The fixed-point bracket (inside/bottom) and the moving end bracket (inside/top) are supplied as standard. However, any other combination can be supplied upon request. The chain bracket is

fastened at the end like a side link. This enables the chain to move right up to the bracket. Each chain requires one male and one female bracket. The brackets should be fastened with M12 screws.

Type	Order No.	Material	Inside width								Outside width of KA 0 mm	Outside width of KA 01 mm
			A mm	B mm	C mm	F mm	G mm	G1 mm	H0 mm	I mm		
KA 102 Female end	1020000050	Sheet steel	93.0 – 518.0	A+2.0	A+38.0	50.0	236.0	328.5	13.0	25.0	A+28.0	A+107.0
KA 102 Male end	1020000051	Sheet steel	93.0 – 518.0	A+2.0	A+38.0	50.0	236.0	328.5	13.0	25.0	A+28.0	A+107.0

**GLP 10 (102.2) GLIDING PLATE**

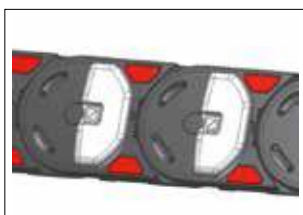

Gliding plate

The gliding plates are mounted in a horizontal position, with the chain laying on its side, to minimize friction wear to the sides. The gliding plates are placed onto the side links instead of the usual chain link side locks (no tools required). The wear limit is 2.5 mm. We recommend replacing the energy chain when this limit has been reached. Depending on the application, the service life of the energy chain may be extended two-fold, by using gliding plates. The energy chain must be placed on its side before opening.

Type	Order No.	Installation site	Gliding plate height mm
GLP10	102290400301	GLP10 gliding plate for the MP102.2	7.0

**TR 102 SEPARATOR**

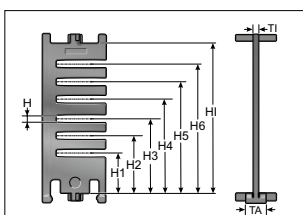

Separator

We recommend that separators be used if multiple round cables or conduits with differing diameters are to be installed.

Type	Order No.	Description	Version	T1 mm	TA mm	H mm	H1 mm	H2 mm	H3 mm	H4 mm	H5 mm	H6 mm	H1 mm
TR 102	1020000092	Separator	lockable	4.0	13.0	5.5	27.6	39.9	52.4	64.7	77.0	89.3	104.0

**RTT 102 SHELF SUPPORT, DIVISIBLE**

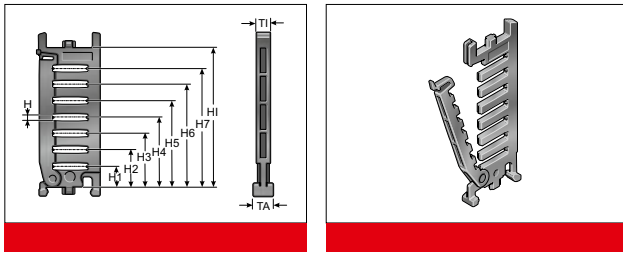

In connection with two separable shelf supports (RTT) with at least one end-to-end shelf (RB) the shelf becomes an easy to fill shelving system. The additional levels prevent cables from criss-crossing and minimise the friction between them.

Type	Order No.	Description	Version	TI mm	TA mm	H mm	H1 mm	H2 mm	H3 mm	H4 mm	H5 mm	H6 mm	H7 mm	H1 mm
RTT 102	100091022000	Shelf support, divisible	lockable	8.0	8.0	5.5	15.4	27.6	39.9	52.4	64.7	77.0	89.3	104.0

**RB-7 SHELF**

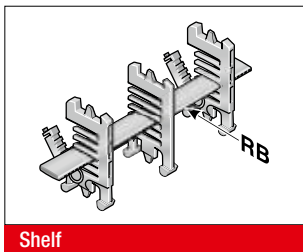

In connection with at least two separable shelf supports (RTT), the shelf becomes a shelving system. The additional levels prevent cables from criss-crossing and minimise the friction between them.

Type	Order No.	Description	Width mm	Inside width mm
RB 056-7	100000005600	Shelf	56.0	93.0
RB 061-7	1000006107	Shelf	61.0	93.0
RB 066-7	100000006600	Shelf	66.0	93.0
RB 071-7	1000007107	Shelf	71.0	93.0
RB 076-7	1000007607	Shelf	76.0	93.0
RB 081-7	100000008100	Shelf	81.0	93.0
RB 086-7	1000008607	Shelf	86.0	93.0
RB 091-7	1000009107	Shelf	91.0	106.0
RB 096-7	1000009607	Shelf	96.0	106.0
RB 101-7	1000010107	Shelf	101.0	106.0
RB 106-7	100000010600	Shelf	106.0	106.0
RB 111-7	1000011107	Shelf	111.0	118.0
RB 116-7	100000011600	Shelf	116.0	118.0
RB 121-7	1000012107	Shelf	121.0	131.0
RB 126-7	1000012607	Shelf	126.0	131.0
RB 131-7	1000013107	Shelf	131.0	143.0
RB 136-7	1000013607	Shelf	136.0	143.0
RB 141-7	1000014107	Shelf	141.0	143.0
RB 146-7	1000014607	Shelf	146.0	156.0
RB 151-7	1000015107	Shelf	151.0	156.0
RB 156-7	1000015607	Shelf	156.0	156.0
RB 161-7	1000016107	Shelf	161.0	168.0
RB 166-7	100000016600	Shelf	166.0	168.0
RB 171-7	1000017107	Shelf	171.0	181.0
RB 176-7	1000017607	Shelf	176.0	181.0
RB 181-7	1000018107	Shelf	181.0	193.0
RB 186-7	1000018607	Shelf	186.0	193.0



**RB-7 SHELF**

Type	Order No.	Description	Width mm	Inside width mm
RB 191-7	1000019107	Shelf	191.0	193.0
RB 196-7	1000019607	Shelf	196.0	206.0
RB 201-7	1000020107	Shelf	201.0	206.0
RB 206-7	1000020607	Shelf	206.0	206.0
RB 211-7	1000021107	Shelf	211.0	218.0
RB 216-7	100000021600	Shelf	216.0	218.0

**RSV 102 CROSSBAR CONNECTOR**



For crossbars wider than 246 mm, we recommend the use of crossbar connectors. These prevent deformation to the crossbar under large amounts of additional weight of the chain assembly.

Type	Order No.	Description	TI mm
RSV 102	1020000096	Crossbar connector	8.0
RSV 102 Alu	1020000098	Crossbar connector for aluminium crossbars	8.0

**RS-ZL CROSSBAR STRAIN RELIEF MP102.2**

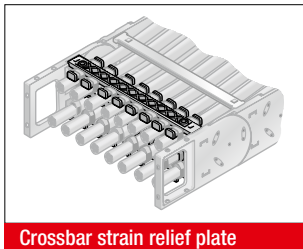

Type	Order No.	Description	Inside width mm
RS-ZL 093-7 MP102.2	80980291	Crossbar strain relief plate	93.0
RS-ZL 106-7 MP102.2	80980292	Crossbar strain relief plate	106.0
RS-ZL 118-7 MP102.2	80980204	Crossbar strain relief plate	118.0
RS-ZL 131-7 MP102.2	80980293	Crossbar strain relief plate	131.0
RS-ZL 143-7 MP102.2	80980160	Crossbar strain relief plate	143.0
RS-ZL 156-7 MP102.2	80980294	Crossbar strain relief plate	156.0
RS-ZL 168-7 MP102.2	80980205	Crossbar strain relief plate	168.0
RS-ZL 181-7 MP102.2	80980295	Crossbar strain relief plate	181.0
RS-ZL 193-7 MP102.2	80980206	Crossbar strain relief plate	193.0
RS-ZL 206-7 MP102.2	80980296	Crossbar strain relief plate	206.0
RS-ZL 218-7 MP102.2	80980207	Crossbar strain relief plate	218.0
RS-ZL 231-7 MP102.2	80980297	Crossbar strain relief plate	231.0
RS-ZL 243-7 MP102.2	80980208	Crossbar strain relief plate	243.0
RS-ZL 256-7 MP102.2	80980298	Crossbar strain relief plate	256.0

**STRAIN RELIEF WITH STEEL FIX**

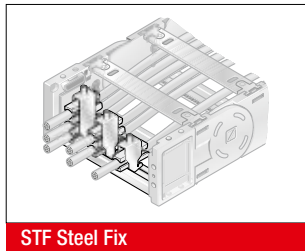
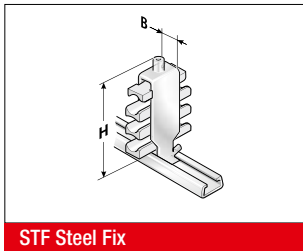

C-rails (galvanised) for permanent integration, for accommodating the Steel Fix bow clamps in the chain brackets. The bow clamps can take up to 3 cables and are suitable for C-rails with a groove width of 11 mm. Due to the design of the trough elements, a cable preserving cable guidance is ensured. May be assembled on the inside and outside bends at both chain endings. The overall height stated is a guide only. The actual height is, amongst other things, dependent on the diameter and the quality of the cable. A safety distance of 10 mm at the fixed point above the strain relief must be kept during gliding applications.

Type	Order No.	Description	Seats qty.	Cable Ø mm	Width mm	Total height (H) mm
<b>Single clamp (for one cable)</b>						
STF 12-1 Steel Fix	81661801	Hooped clamp	1	6.0 – 12.0	16.0	55.0
STF 14-1 Steel Fix	81661802	Hooped clamp	1	12.0 – 14.0	18.0	52.0
STF 16-1 Steel Fix	81661803	Hooped clamp	1	14.0 – 16.0	20.0	54.0
STF 18-1 Steel Fix	81661804	Hooped clamp	1	16.0 – 18.0	22.0	56.0
STF 20-1 Steel Fix	81661805	Hooped clamp	1	18.0 – 20.0	24.0	59.0
STF 22-1 Steel Fix	81661806	Hooped clamp	1	20.0 – 22.0	26.0	61.0
STF 26-1 Steel Fix	81661807	Hooped clamp	1	22.0 – 26.0	30.0	70.0
STF 30-1 Steel Fix	81661808	Hooped clamp	1	26.0 – 30.0	34.0	74.0
STF 34-1 Steel Fix	81661809	Hooped clamp	1	30.0 – 34.0	38.0	78.0
STF 38-1 Steel Fix	81661810	Hooped clamp	1	34.0 – 38.0	42.0	82.0
STF 42-1 Steel Fix	81661811	Hooped clamp	1	38.0 – 42.0	46.0	91.0
<b>Double clamp (for two cables)</b>						
STF 12-2 Steel Fix	81661821	Hooped clamp	2	6.0 – 12.0	16.0	73.0
STF 14-2 Steel Fix	81661822	Hooped clamp	2	12.0 – 14.0	18.0	74.0
STF 16-2 Steel Fix	81661823	Hooped clamp	2	14.0 – 16.0	20.0	82.0
STF 18-2 Steel Fix	81661824	Hooped clamp	2	16.0 – 18.0	22.0	86.0
STF 20-2 Steel Fix	81661825	Hooped clamp	2	18.0 – 20.0	24.0	91.0
STF 22-2 Steel Fix	81661826	Hooped clamp	2	20.0 – 22.0	26.0	95.0
STF 26-2 Steel Fix	81661827	Hooped clamp	2	22.0 – 26.0	30.0	108.0
STF 30-2 Steel Fix	81661828	Hooped clamp	2	26.0 – 30.0	34.0	121.0
STF 34-2 Steel Fix	81661829	Hooped clamp	2	30.0 – 34.0	38.0	129.0
<b>Triple clamp (for three cables)</b>						
STF 12-3 Steel Fix	81661841	Hooped clamp	3	6.0 – 12.0	16.0	98.0
STF 14-3 Steel Fix	81661842	Hooped clamp	3	12.0 – 14.0	18.0	98.0
STF 16-3 Steel Fix	81661843	Hooped clamp	3	14.0 – 16.0	20.0	105.0
STF 18-3 Steel Fix	81661844	Hooped clamp	3	16.0 – 18.0	22.0	111.0
STF 20-3 Steel Fix	81661845	Hooped clamp	3	18.0 – 20.0	24.0	118.0
STF 22-3 Steel Fix	81661846	Hooped clamp	3	20.0 – 22.0	26.0	130.0

**MP 102.2 LOWERED FIXING POINT**

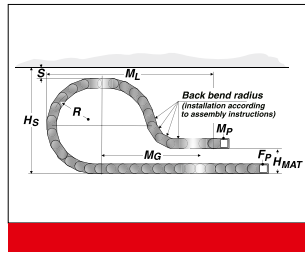
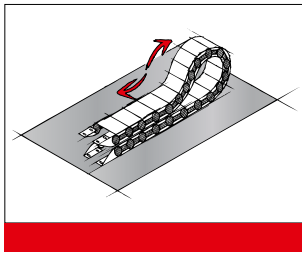

It is sometimes necessary to lower the height of the moving attachment point.

In such cases, modifications to the chain layout should be noted (e.g. extension of chain).

Please contact our application engineers.

Radius R mm	Height of moving end bracket (H <sub>MA</sub> ) mm	Safety margin (S) mm	Installation height incl. safety (H <sub>S</sub> ) mm	Projection (M <sub>L</sub> ) mm	Additional links qty.	of which additional back chain links qty.
250.0	250.0	60.0	695.0	880.0	9	3
300.0	270.0	60.0	795.0	1020.0	10	3
400.0	390.0	60.0	995.0	1220.0	12	3
500.0	420.0	60.0	1200.0	1490.0	15	3

**MP 102 REARWARD RADII**

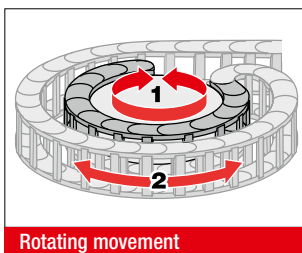

Rotating movement

Side links with rearward radius allow movements in both directions. This is intended for rotating movements and lowered chain brackets. Note: This type of chain has different chain links for the left or right side! Rotation movements are only possible with open variants.

Type	Order No.	Radius mm	Rearward radius mm
SR 102 (RÜ400/R400) left	10200040060	400.0	400.0
SR 102 (RÜ400/R400) right	10200040062	400.0	400.0

**GUIDE CHANNEL VAW (ALUMINIUM)**



VAW aluminium

A variable guide channel system, constructed from aluminium sections, is available for this energy chain. The variable guide channel ensures that the energy chain is supported and guided securely.

ASSEMBLY

DISASSEMBLY

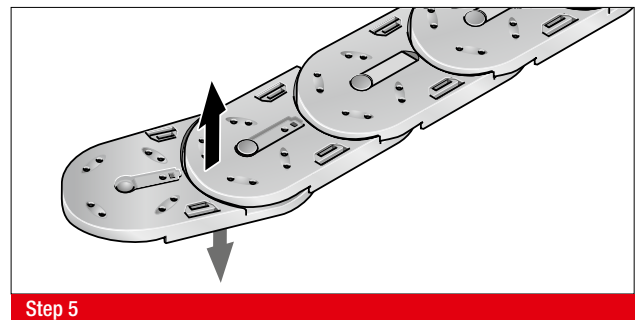
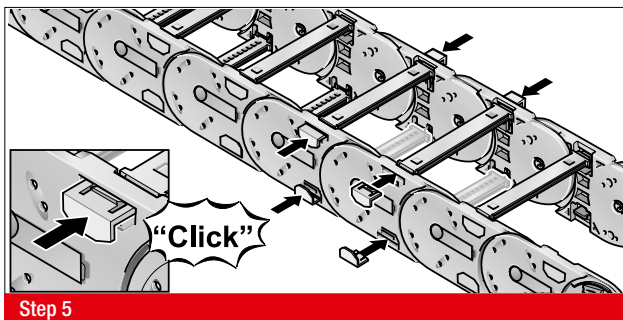
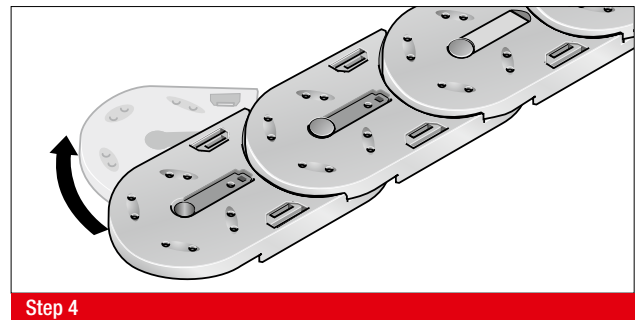
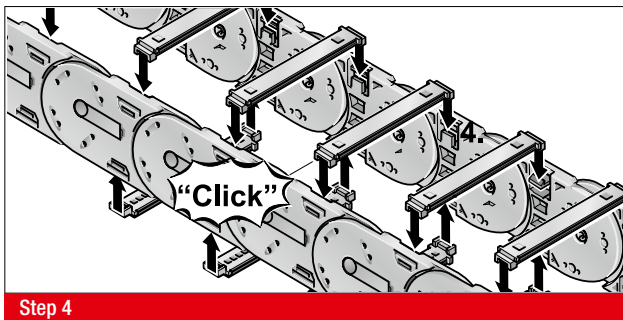
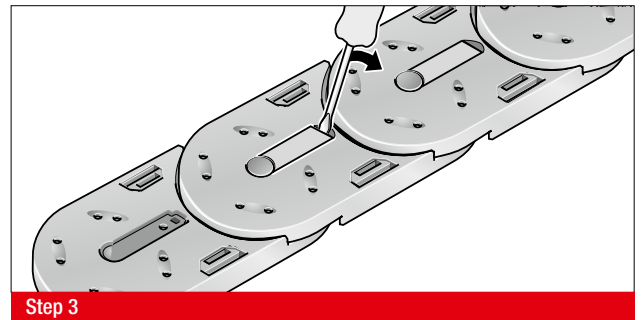
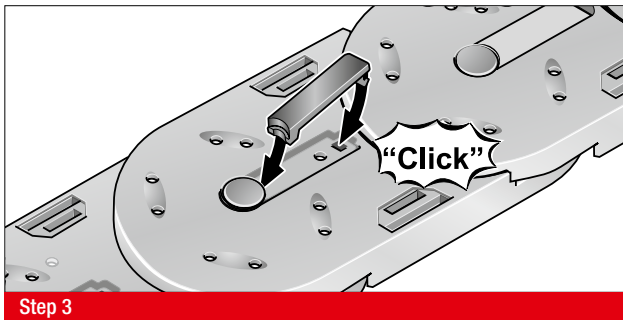
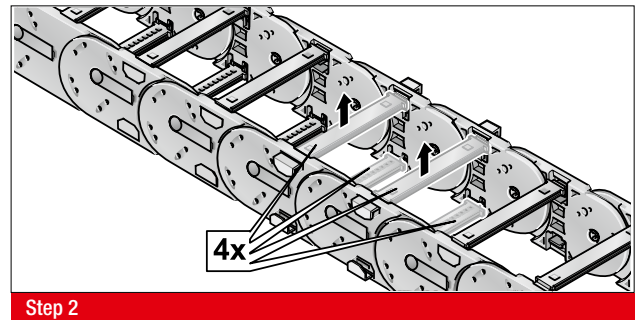
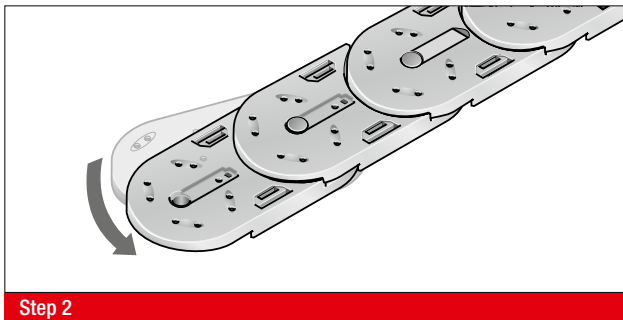
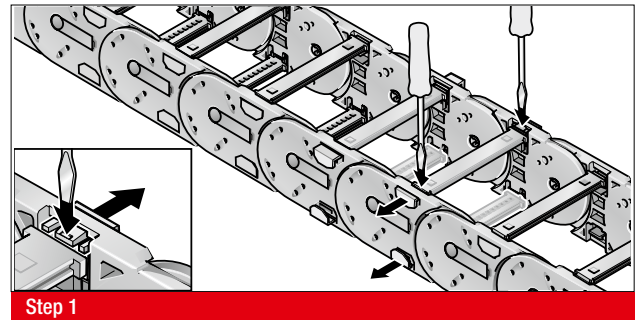
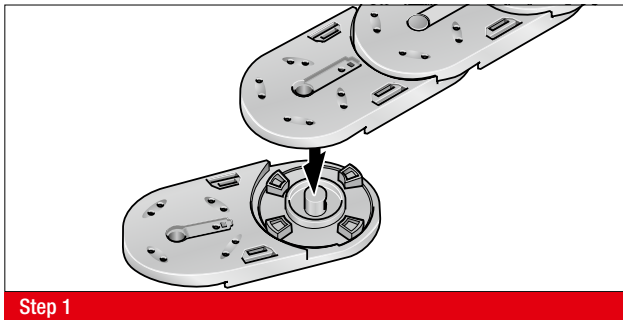



## MP 32 OPEN



- PLASTIC OR ALUMINIUM VERSION
- CHAIN BRACKET FLEXIBLE
- BROAD INTERIOR LAYOUT

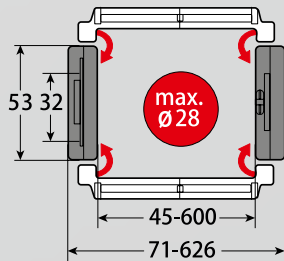

### TECHNICAL DATA

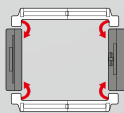

**Loading side**  
Inside and outside bend

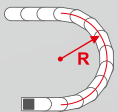

**Available radii**  
80.0 – 250.0 mm

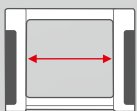

**Available interior widths**  
With plastic crossbar  
45.0 – 546.0 mm  
With alu crossbar / with alu cover  
67.0 – 600.0 mm /

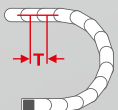

**Pitch**  
T = 64.5 mm

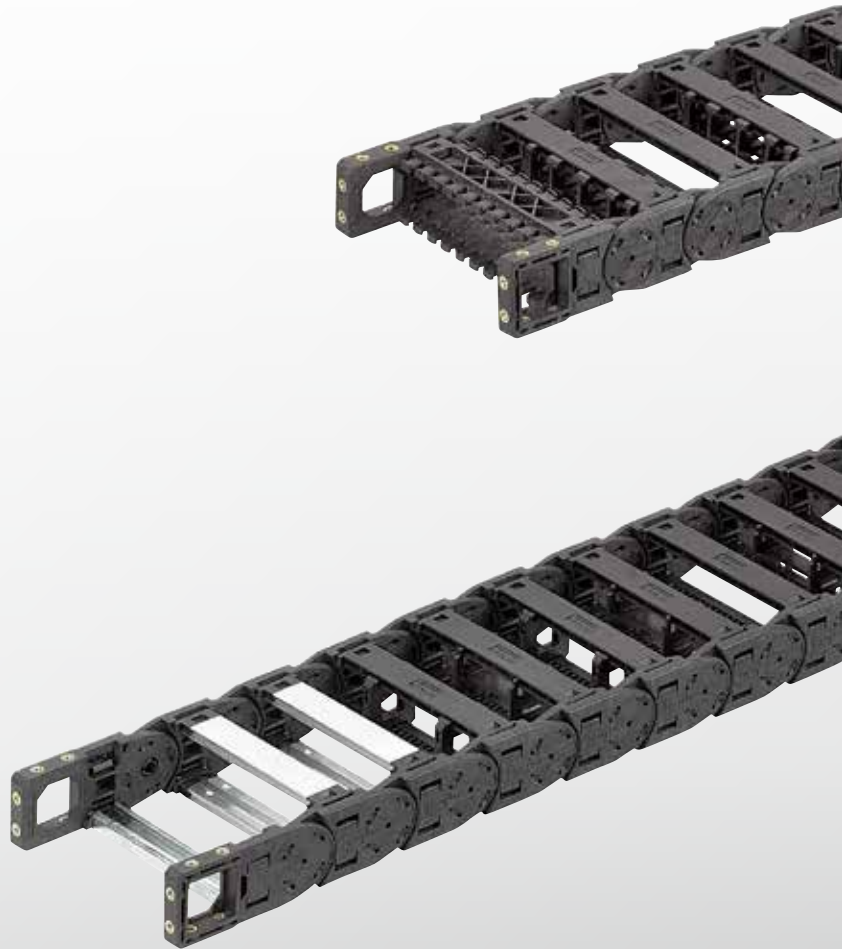



## TECHNICAL SPECIFICATIONS

Travel distance gliding $L_g$ max.	100.0 m
Travel distance self-supporting $L_s$ max.	see diagram on page 333
Travel distance vertical, hanging $L_{vh}$ max.	40.0 m
Travel distance vertical, upright $L_{vs}$ max.	5.0 m
Rotated 90°, unsupported $L_{90f}$ max.	2.0 m
Speed, gliding $V_g$ max.	5.0 m/s
Speed, self-supporting $V_s$ max.	20.0 m/s
Acceleration, gliding $a_g$ max.	25.0 m/s <sup>2</sup>
Acceleration, self-supporting $a_s$ max.	30.0 m/s <sup>2</sup>

Contact our engineering department to meet any higher requirements: [efk@murrplastik.de](mailto:efk@murrplastik.de)

## MATERIAL PROPERTIES

Standard material	Polyamide (PA) black
Service temperature	-30.0 – 120.0 °C
Gliding friction factor	0.3
Static friction factor	0.45
Fire classification	UL 94 HB

Other material properties on request.

## SHELVING SYSTEM



Separator TR



RS shelving system



Crossbar connector RSV

## CHAIN BRACKET

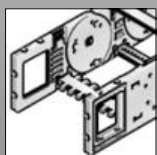

Chain bracket flexible

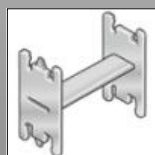

H-shaped shelf unit RE

## ACCESSORIES



Bracket bar

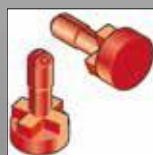

Lock button

## GUIDE CHANNELS



VAW steel galvanised / stainless steel

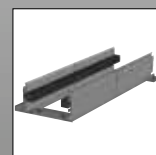

VAW aluminium

## STRAIN RELIEF

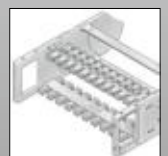

RS-ZL crossbar strain relief



STF Steel Fix

ORDERING KEY

Type code	Variation	Inside width	Outside width	Inside width	Outside width	Radius	Crossbar variant	Material	Chain length
<b>0320 30</b>	Crossbar on outside bend Crossbar on inside bend Opens on inside and outside bend	<b>045</b> [1.77]	<b>071</b> [2.80]	<b>233</b> [9.17]	<b>259</b> [10.20]	<b>080</b> [3.15]	<b>0</b> Plastic, full-ridged with bias	<b>0</b> Polyamide standard (PA/black)	
		<b>057</b> [2.24]	<b>083</b> [3.27]	<b>246</b> [9.69]	<b>272</b> [10.71]				
		<b>062</b> [2.44]	<b>088</b> [3.46]	<b>252</b> [9.92]	<b>278</b> [10.94]	<b>100</b> [3.94]	<b>2</b> Plastic, half-ridged with bias	<b>9</b> Special version (on request)	
		<b>071</b> [2.80]	<b>097</b> [3.82]	<b>258</b> [10.16]	<b>284</b> [11.18]				
		<b>084</b> [3.31]	<b>110</b> [4.33]	<b>296</b> [11.65]	<b>322</b> [12.68]	<b>120</b> [4.72]	<b>4</b> Aluminium full-ridged with bias		
		<b>093</b> [3.66]	<b>119</b> [4.69]	<b>346</b> [13.62]	<b>372</b> [14.65]				
		<b>096</b> [3.78]	<b>122</b> [4.80]	<b>350</b> [13.78]	<b>376</b> [14.80]	<b>150</b> [5.91]	<b>6</b> Aluminium half-ridged with bias		
		<b>104</b> [4.09]	<b>130</b> [5.12]	<b>358</b> [14.09]	<b>384</b> [15.12]				
		<b>107</b> [4.21]	<b>133</b> [5.24]	<b>371</b> [14.61]	<b>397</b> [15.63]	<b>200</b> [7.87]	<b>9</b> Special version (on request)		
		<b>121</b> [4.76]	<b>147</b> [5.79]	<b>396</b> [15.59]	<b>422</b> [16.61]				
		<b>133</b> [5.24]	<b>159</b> [6.26]	<b>421</b> [16.57]	<b>447</b> [17.60]	<b>250</b> [9.84]			
		<b>144</b> [5.67]	<b>170</b> [6.69]	<b>446</b> [17.56]	<b>472</b> [18.58]				
		<b>146</b> [5.75]	<b>172</b> [6.77]	<b>496</b> [19.53]	<b>522</b> [20.55]				
		<b>158</b> [6.22]	<b>184</b> [7.24]	<b>546</b> [21.50]	<b>572</b> [22.52]				
		<b>164</b> [6.46]	<b>190</b> [7.48]						
		<b>171</b> [6.73]	<b>197</b> [7.76]						
		<b>182</b> [7.17]	<b>208</b> [8.19]						
		<b>196</b> [7.72]	<b>222</b> [8.74]						
		<b>208</b> [8.19]	<b>234</b> [9.21]						
		<b>220</b> [8.66]	<b>246</b> [9.69]						

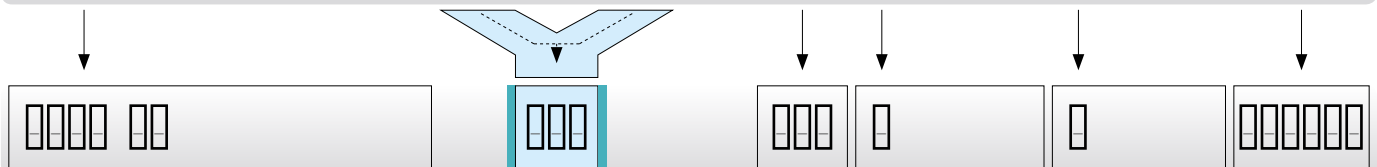

ORDERING EXAMPLE: 0320 30 045 080 0 0 1290

Crossbar on outside bend, crossbar on inside bend, can be opened from inside and outside bend  
 Inside width 45 mm; radius 80 mm  
 Plastic crossbar, full-ridged with bias, material black-coloured polyamide  
 Chain length 1290 mm (20 links)



**NOTE ON CONFIGURATION**

**Aluminium crossbars:**

Aluminium crossbars can be supplied in 1 mm width sizes for inner widths from 67.0 mm – 600.0 mm .

**Crossbar connector and crossbar strain relief plate:**

Once inside widths exceed 246 mm, we recommend the deployment of crossbar connectors (RSV).  
If crossbar strain relief plates (RS-ZL) are to be deployed in the chain brackets, take standard inside widths into account.

For detailed information, please consult the corresponding product documentation.

**SELF-SUPPORTING LENGTH**

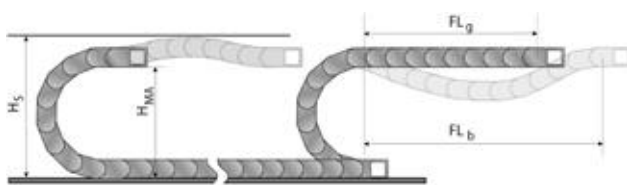

The self-supporting length is the distance between the chain bracket on the moving end and the start of the chain arch. The installation variant  $FL_g$  offers the lowest load and wear for the energy chain. The maximum travel parameters (speed and acceleration) can be applied for this variant.

- $H_s$  = Installation height plus safety
- $H_{MA}$  = Height of moving end connection
- $FL_g$  = Self-supporting length, upper run straight
- $FL_b$  = Self-supporting length, upper run bent

**LOAD DIAGRAM FOR SELF-SUPPORTING APPLICATIONS**

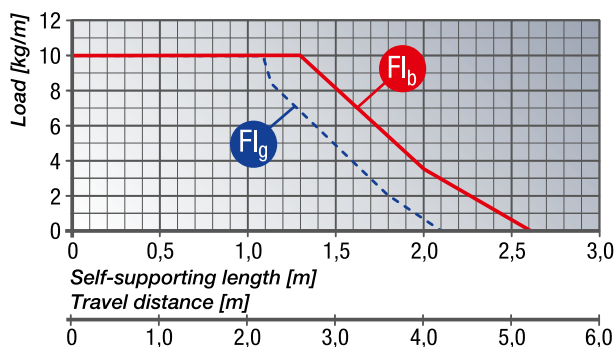

**$FL_g$  Self-supporting length, upper run straight**  
In the  $FL_g$  range, the chain upper run still has a bias, is straight or has a maximum sag of 70.0 mm.

**$FL_b$  Self-supporting length, upper run bent**  
In the  $FL_b$  range, the chain upper run has a sag of more than 70.0 mm, but this is still less than the maximum sag. Where the sag is greater than that permitted in the  $FL_b$  range, the application is critical and should be avoided. The self-supporting length can be optimised by using a support for the upper run or a more stable energy chain.

**DETERMINING THE CHAIN LENGTH**

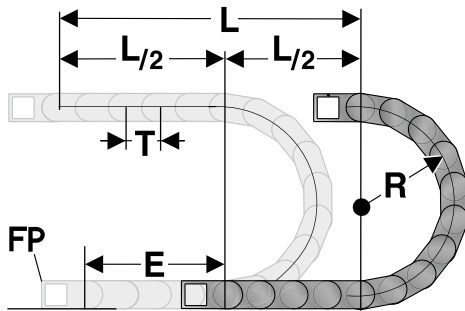

The fixed point of the energy chain should be connected in the middle of the travel distance.

This arrangement gives the shortest connection between the fixed point (FP) and the moving consumer and thus the most efficient chain length.

Chain length calculation =  $L/2 + \pi * R + E$   
 $\approx 1 \text{ m chain} = 16 \text{ qty. x64.5 mm.}$

$E$  = Distance between entry point and middle of travel distance

$L$  = Travel distance

$R$  = Radius

$P$  = Pitch 64.5 mm

**INSTALLATION DIMENSIONS**

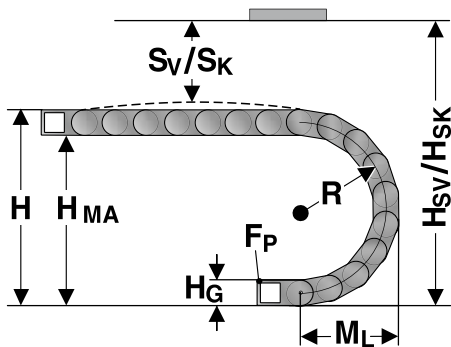

The moving end chain connection is to be screw fixed at height  $H_{MA}$  for the respective radius.

For the installed dimension the "Installed height  $H_s$ " value has to be taken into account.

Radius R	80	100	120	150	200	250
Outside height of chain link ( $H_o$ )	53	53	53	53	53	53
Height of bend (H)	233	273	313	373	473	573
Height of moving end bracket ( $H_{MA}$ )	180	220	260	320	420	520
Safety margin (S)	30	30	30	30	30	30
Installation height ( $H_s$ )	263	303	343	403	503	603
Arc projection ( $M_L$ )	181	201	221	251	301	351

## POWERLINE PLASTIC CROSSBAR



The crossbars connect the two side runs of the energy chain.  
The crossbar length is synonymous with the inside width of the energy chain.

Type	Order No.	Description	Inside width mm
RS 045-5	052004500000	Crossbar	45.0
RS 057-5	052005700000	Crossbar	57.0
RS 062-5	052006200000	Crossbar	62.0
RS 071-5	052007100000	Crossbar	71.0
RS 084-5	052008400000	Crossbar	84.0
RS 093-5	052009300000	Crossbar	93.0
RS 096-5	052009600000	Crossbar	96.0
RS 104-5	052010400000	Crossbar	104.0
RS 107-5	052010700000	Crossbar	107.0
RS 121-5	052012100000	Crossbar	121.0
RS 133-5	052013300000	Crossbar	133.0
RS 144-5	052014400000	Crossbar	144.0
RS 146-5	052014600000	Crossbar	146.0
RS 158-5	052015800000	Crossbar	158.0
RS 164-5	052016400000	Crossbar	164.0
RS 171-5	052017100000	Crossbar	171.0
RS 182-5	052018200000	Crossbar	182.0
RS 196-5	052019600000	Crossbar	196.0
RS 208-5	052020800000	Crossbar	208.0
RS 220-5	052022000000	Crossbar	220.0
RS 233-5	052023300000	Crossbar	233.0
RS 246-5	052024600000	Crossbar	246.0
RS 252-5	052025200010	Crossbar	252.0
RS 258-5	052025800000	Crossbar	258.0
RS 296-5	052029600000	Crossbar	296.0
RS 346-5	052034600000	Crossbar	346.0
RS 350-5	052035000000	Crossbar	350.0
RS 358-5	052035800000	Crossbar	358.0
RS 371-5	052037100000	Crossbar	371.0
RS 396-5	052039600000	Crossbar	396.0
RS 421-5	052042100000	Crossbar	421.0
RS 446-5	052044600000	Crossbar	446.0
RS 496-5	052049600000	Crossbar	496.0
RS 546-5	052054600000	Crossbar	546.0

**KA 32 CHAIN BRACKET FLEXIBLE**

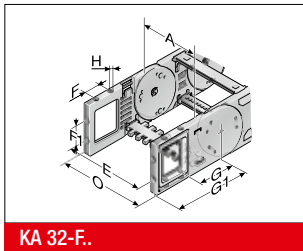

This chain bracket offers universal connection options (top, bottom and front) and is attached to the ends of the chain like a side link. This allows the chain to move right up to the bracket. Each chain requires one male and one female bracket. M5 bolts are used to secure the brackets in place. Extrusion-coated metal bushes with either a through-hole (-FB) or a threaded hole (-FG) ensure the permanent, high-strength transmission of even extreme forces onto the energy chain.

Type	Order No.	Material	Version	Inside width								Outside width of KA 0 mm
				A mm	E mm	F mm	F1 mm	G mm	G1 mm	H mm	H0 mm	
KA 32-FB	0321000054	Plastic	with bush	45.0 – 546.0	A+14.0	22.5	22.0	57.8	95.5	5.5	A+28.0	
KA 32-FG	0321000055	Plastic	with thread	45.0 – 546.0	A+14.0	22.5	22.0	57.8	95.5	M5	A+28.0	

**TR 32 SEPARATOR**

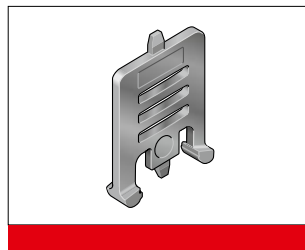
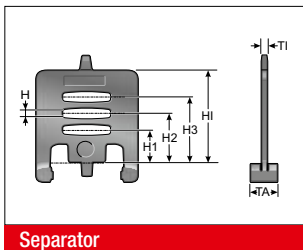

We recommend that separators be used if multiple round cables or conduits with differing diameters are to be installed.

Type	Order No.	Description	Version	TI mm	TA mm	H mm	H1 mm	H2 mm	H3 mm	HI mm
TR 32	032000009200	Separator	lockable	3.0	10.0	4.2	10.4	16.2	22.0	32.0

**TR 32.1 SEPARATOR**

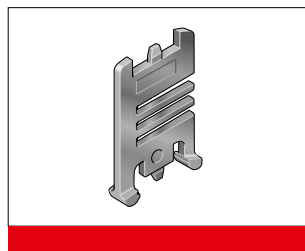
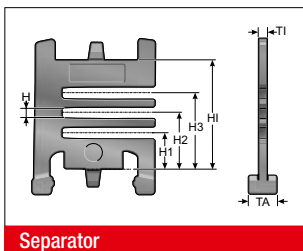

We recommend that separators be used if multiple round cables or conduits with differing diameters are to be installed.

Type	Order No.	Description	Version	TI mm	TA mm	H mm	H1 mm	H2 mm	H3 mm	HI mm
TR 32.1	032200009200	Separator	lockable	3.5	8.0	4.0	10.5	16.5	22.5	32.0

**RTT 32 SHELF SUPPORT, DIVISIBLE**

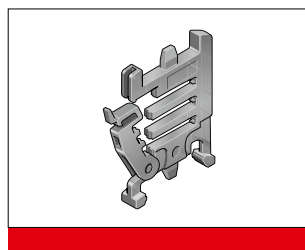
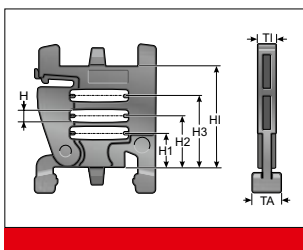

In connection with two separable shelf supports (RTT) with at least one end-to-end shelf (RB) the shelf becomes an easy to fill shelving system. The additional levels prevent cables from criss-crossing and minimise the friction between them.

Type	Order No.	Description	Version	TI mm	TA mm	H mm	H1 mm	H2 mm	H3 mm	HI mm
RTT 32	100090322000	Shelf support, divisible	lockable	7.0	8.0	4.0	10.5	16.5	22.5	32.0

## RB-5 SHELF

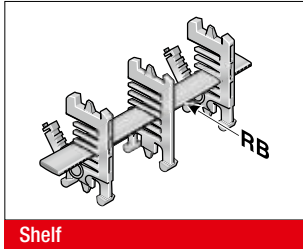

In connection with at least two separable shelf supports (RTT), the shelf becomes a shelving system. The additional levels prevent cables from criss-crossing and minimise the friction between them.

Type	Order No.	Description	Width mm	Inside width mm
RB 028-5	10000002800	Shelf	28.0	45.0
RB 034-5	1000003405	Shelf	33.6	45.0
RB 039-5	1000003905	Shelf	39.2	45.0
RB 045-5	1000004505	Shelf	44.8	57.0
RB 050-5	1000005005	Shelf	50.4	57.0
RB 056-5	10000005601	Shelf	56.0	62.0
RB 062-5	1000006205	Shelf	61.6	62.0
RB 067-5	1000006705	Shelf	67.2	84.0
RB 073-5	1000007305	Shelf	72.8	84.0
RB 078-5	1000007805	Shelf	78.4	84.0
RB 084-5	10000008400	Shelf	84.0	84.0
RB 090-5	1000009005	Shelf	89.6	96.0
RB 095-5	1000009505	Shelf	95.2	96.0
RB 101-5	1000010105	Shelf	100.8	107.0
RB 106-5	1000010605	Shelf	106.4	107.0
RB 112-5	100000011200	Shelf	112.0	121.0
RB 118-5	1000011805	Shelf	117.6	121.0
RB 123-5	1000012305	Shelf	123.2	133.0
RB 129-5	1000012905	Shelf	128.8	133.0
RB 134-5	1000013405	Shelf	134.4	144.0
RB 140-5	100000014000	Shelf	140.0	144.0
RB 146-5	1000014605	Shelf	145.6	158.0
RB 151-5	1000015105	Shelf	151.2	158.0
RB 157-5	1000015705	Shelf	156.8	164.0
RB 162-5	1000016205	Shelf	162.4	164.0
RB 168-5	100000016800	Shelf	168.0	182.0
RB 174-5	1000017405	Shelf	173.6	182.0
RB 179-5	1000017905	Shelf	179.2	196.0
RB 185-5	1000018505	Shelf	184.8	196.0
RB 190-5	1000019005	Shelf	190.4	196.0
RB 196-5	100000019600	Shelf	196.0	196.0
RB 291-5	100000029100	Shelf	291.2	346.0

**RSV 32 CROSSBAR CONNECTOR**



For crossbars wider than 246 mm, we recommend the use of crossbar connectors. These prevent deformation to the crossbar under large amounts of additional weight of the chain assembly.

Type	Order No.	Description	Tl mm
RSV 32	032000009600	Crossbar connector	7.5
RSV 32 Alu	032000009800	Crossbar connector for aluminium crossbars	7.5

**RE 32 H-SHAPED SHELF UNIT**

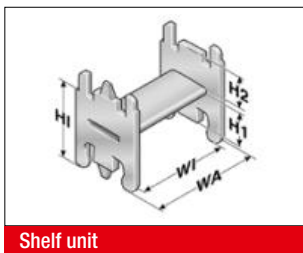

One-piece shelving system, the shelf cannot be varied in height.

Type	Order No.	Description	WA mm	WI mm	H1 mm	H2 mm	Hl mm
RE 32/35	100000322010	H-shaped shelf unit	43.2	35.2	14.2	14.2	32.4
RE 32/52	100000323510	H-shaped shelf unit	60.0	52.0	14.2	14.2	32.4
RE 32/75	100000327510	H-shaped shelf unit	82.4	74.4	16.4	12.0	32.4

**BS-5 BRACKET BAR**



Large-diameter conduits are routed securely by using a bracket bar (BS). This bar is installed on the crossbars or the covers of the energy chain.

The bracket bar can be installed on both the inside and outside bend.

The bracket bar support (BSH) is used to attach the bars to PowerLine series crossbars. Two bracket bar supports are required for each bar.

Type	Order No.	Description	Conduit diameter max. mm	Installation height mm	Inner chain width min. mm
BS 120-5	052412000000	Bracket bar	115.0	140.0	164.0
BS 153-5	052415300000	Bracket bar	148.0	170.0	208.0
BS 187-5	052418700000	Bracket bar	182.0	205.0	233.0
BSH-5	052400000000	Bracket bar support			
Assembly set	052400000001	Assembly set			

## RS-ZL-5 CROSSBAR STRAIN RELIEF PLATE

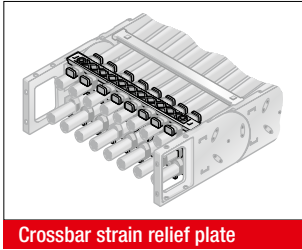

Crossbar strain relief plate

Fixed integrated frame bridge strain relief plates in the chain brackets. Tailored to all crossbar widths up to 246 mm. May be assembled on the inside and outside bends at both chain endings.

Type	Order No.	Description	Inside width mm
RS-ZL 045-5	052004500010	Crossbar strain relief plate	45.0
RS-ZL 057-5	052005700010	Crossbar strain relief plate	57.0
RS-ZL 062-5	052006200010	Crossbar strain relief plate	62.0
RS-ZL 071-5	052007100010	Crossbar strain relief plate	71.0
RS-ZL 084-5	052008400010	Crossbar strain relief plate	84.0
RS-ZL 093-5	052009300010	Crossbar strain relief plate	93.0
RS-ZL 096-5	052009600010	Crossbar strain relief plate	96.0
RS-ZL 104-5	052010400010	Crossbar strain relief plate	104.0
RS-ZL 107-5	052010700010	Crossbar strain relief plate	107.0
RS-ZL 121-5	052012100010	Crossbar strain relief plate	121.0
RS-ZL 133-5	052013300010	Crossbar strain relief plate	133.0
RS-ZL 144-5	052014400010	Crossbar strain relief plate	144.0
RS-ZL 146-5	052014600010	Crossbar strain relief plate	146.0
RS-ZL 158-5	052015800010	Crossbar strain relief plate	158.0
RS-ZL 164-5	052016400010	Crossbar strain relief plate	164.0
RS-ZL 171-5	052017100010	Crossbar strain relief plate	171.0
RS-ZL 182-5	052018200010	Crossbar strain relief plate	182.0
RS-ZL 196-5	052019600010	Crossbar strain relief plate	196.0
RS-ZL 208-5	052020800010	Crossbar strain relief plate	208.0
RS-ZL 220-5	052022000010	Crossbar strain relief plate	220.0
RS-ZL 233-5	052023300010	Crossbar strain relief plate	233.0
RS-ZL 246-5	052024600010	Crossbar strain relief plate	246.0

**STRAIN RELIEF WITH STEEL FIX**

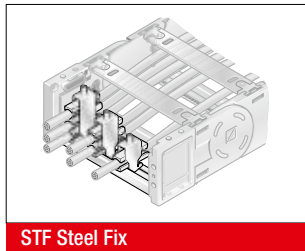
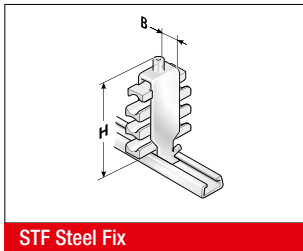

C-rails (galvanised) for permanent integration, for accommodating the Steel Fix bow clamps in the chain brackets. The bow clamps can take up to 3 cables and are suitable for C-rails with a groove width of 11 mm. Due to the design of the trough elements, a cable preserving cable guidance is ensured. May be assembled on the inside and outside bends at both chain endings. The overall height stated is a guide only. The actual height is, amongst other things, dependent on the diameter and the quality of the cable. A safety distance of 10 mm at the fixed point above the strain relief must be kept during gliding applications.

Type	Order No.	Description	Seats qty.	Cable Ø mm	Width mm	Total height (H) mm
<b>Single clamp (for one cable)</b>						
STF 12-1 Steel Fix	81661801	Hooped clamp	1	6.0 – 12.0	16.0	55.0
STF 14-1 Steel Fix	81661802	Hooped clamp	1	12.0 – 14.0	18.0	52.0
STF 16-1 Steel Fix	81661803	Hooped clamp	1	14.0 – 16.0	20.0	54.0
STF 18-1 Steel Fix	81661804	Hooped clamp	1	16.0 – 18.0	22.0	56.0
STF 20-1 Steel Fix	81661805	Hooped clamp	1	18.0 – 20.0	24.0	59.0
STF 22-1 Steel Fix	81661806	Hooped clamp	1	20.0 – 22.0	26.0	61.0
STF 26-1 Steel Fix	81661807	Hooped clamp	1	22.0 – 26.0	30.0	70.0
STF 30-1 Steel Fix	81661808	Hooped clamp	1	26.0 – 30.0	34.0	74.0
STF 34-1 Steel Fix	81661809	Hooped clamp	1	30.0 – 34.0	38.0	78.0
STF 38-1 Steel Fix	81661810	Hooped clamp	1	34.0 – 38.0	42.0	82.0
STF 42-1 Steel Fix	81661811	Hooped clamp	1	38.0 – 42.0	46.0	91.0
<b>Double clamp (for two cables)</b>						
STF 12-2 Steel Fix	81661821	Hooped clamp	2	6.0 – 12.0	16.0	73.0
STF 14-2 Steel Fix	81661822	Hooped clamp	2	12.0 – 14.0	18.0	74.0
STF 16-2 Steel Fix	81661823	Hooped clamp	2	14.0 – 16.0	20.0	82.0
STF 18-2 Steel Fix	81661824	Hooped clamp	2	16.0 – 18.0	22.0	86.0
STF 20-2 Steel Fix	81661825	Hooped clamp	2	18.0 – 20.0	24.0	91.0
STF 22-2 Steel Fix	81661826	Hooped clamp	2	20.0 – 22.0	26.0	95.0
STF 26-2 Steel Fix	81661827	Hooped clamp	2	22.0 – 26.0	30.0	108.0
STF 30-2 Steel Fix	81661828	Hooped clamp	2	26.0 – 30.0	34.0	121.0
STF 34-2 Steel Fix	81661829	Hooped clamp	2	30.0 – 34.0	38.0	129.0
<b>Triple clamp (for three cables)</b>						
STF 12-3 Steel Fix	81661841	Hooped clamp	3	6.0 – 12.0	16.0	98.0
STF 14-3 Steel Fix	81661842	Hooped clamp	3	12.0 – 14.0	18.0	98.0
STF 16-3 Steel Fix	81661843	Hooped clamp	3	14.0 – 16.0	20.0	105.0
STF 18-3 Steel Fix	81661844	Hooped clamp	3	16.0 – 18.0	22.0	111.0
STF 20-3 Steel Fix	81661845	Hooped clamp	3	18.0 – 20.0	24.0	118.0
STF 22-3 Steel Fix	81661846	Hooped clamp	3	20.0 – 22.0	26.0	130.0



**MP 32/41 LOCK BUTTON**

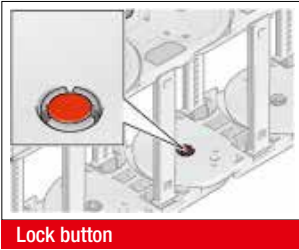

Lock button

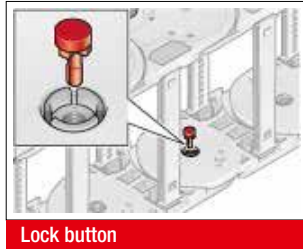

Lock button

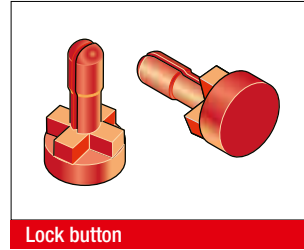

Lock button

To increase the side stability, we recommend the use of lock buttons during strong lateral acceleration or when installed

“laying on the side (turned 90°) without support”.

Type	Order No.
MP32/41 lock button	041000008000

**MP 32 LOWERED FIXING POINT**

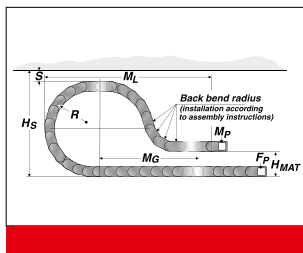
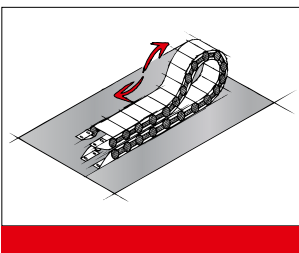

It is sometimes necessary to lower the height of the moving attachment point.

In such cases, modifications to the chain layout should be noted (e.g. extension of chain).

Please contact our application engineers.

Radius R mm	Height of moving end bracket (H <sub>MA</sub> ) mm	Safety margin (S) mm	Installation height incl. safety (H <sub>S</sub> ) mm	Projection (M <sub>L</sub> ) mm	Additional links qty.	of which additional back chain links qty.
200.0	210.0	50.0	523.0	720.0	14	3
250.0	230.0	50.0	623.0	880.0	17	3

**MP 32 REARWARD RADII**

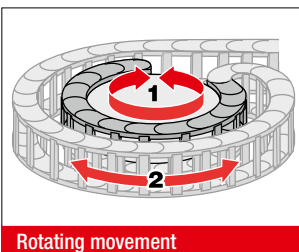

Rotating movement

Side links with rearward radius allow movements in both directions. This is intended for rotating movements and lowered chain brackets. Rotation movements are only possible with open variants.

Type	Order No.	Radius mm	Rearward radius mm
SR 32 (RÜ200/R120)	032000008060	120.0	200.0
SR 32 (RÜ200/R135)	032000010060	135.0	200.0
SR 32 (RÜ200/R150)	032000012060	150.0	200.0
SR 32 (RÜ200/R170)	032000015060	170.0	200.0
SR 32 (RÜ200/R200)	032000020060	200.0	200.0
SR 32 (RÜ200/R250)	032000025060	250.0	200.0

**GUIDE CHANNEL VAW (ALUMINIUM / STAINLESS STEEL)**



VAW steel galvanised / stainless steel



VAW aluminium

A range of variable guide channel systems, constructed from aluminium or stainless steel sections, are available for this energy chain.

The variable guide channel ensures that the energy chain is supported and guided securely.

**ASSEMBLY INSTRUCTION FLEXIBLE CHAIN BRACKET FB/FG**

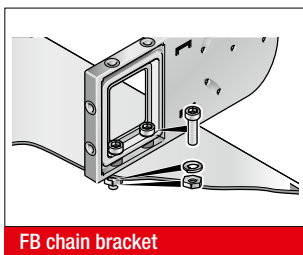

FB chain bracket

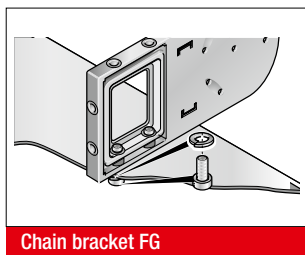

Chain bracket FG

Brass bushes guarantee long-lasting fastening without cold flow in the plastic.

**Version KA-FB:**

Integrated through-hole fastened down using screw and nut.

**Version KA-FG:**

Built-in threads allow for quick and easy on-site mounting, since a screw, including a retaining washer where necessary, is sufficient.

**ASSEMBLY**

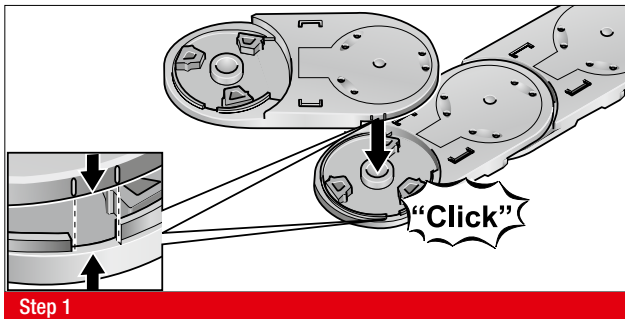

Step 1

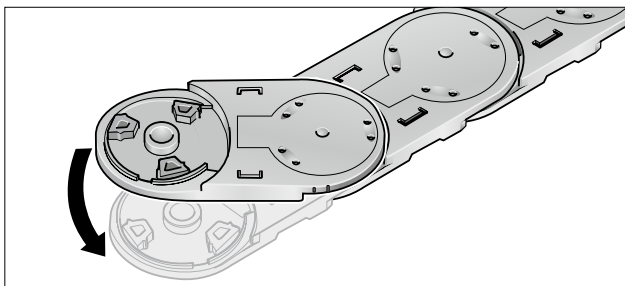

Step 2

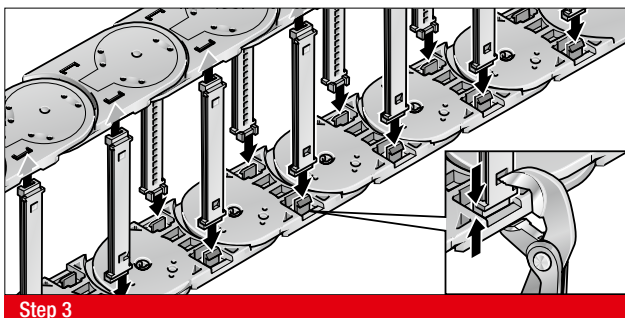

Step 3

**DISASSEMBLY**

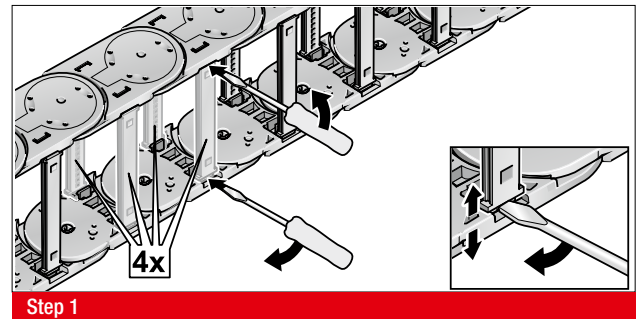

Step 1

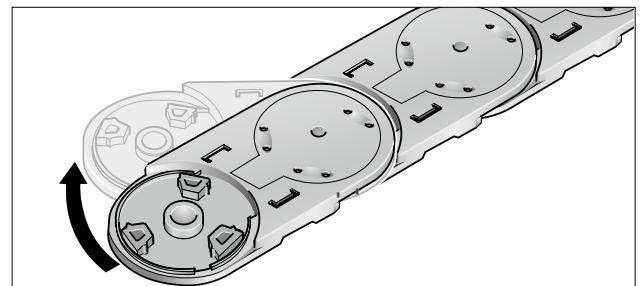

Step 2

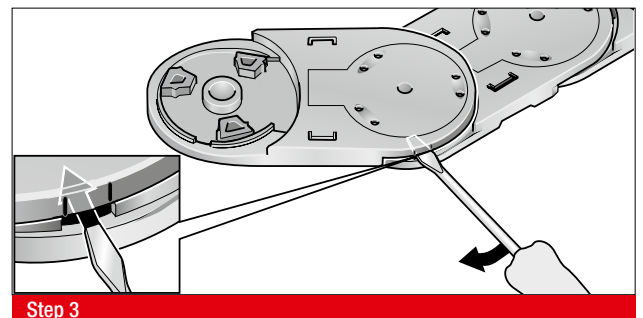

Step 3



## MP 35 OPEN



- METAL CHAIN BRACKET
- LOW-COST VARIANT

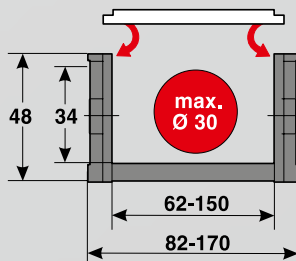

### TECHNICAL DATA

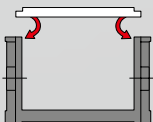

**Loading side**  
Inside bend

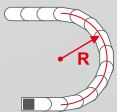

**Available radii**  
70.0 – 300.0 mm

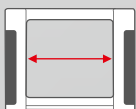

**Available interior widths**  
With plastic crossbar  
62.0 – 150.0 mm

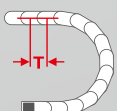

**Pitch**  
T = 58.0 mm



## TECHNICAL SPECIFICATIONS

Travel distance gliding $L_g$ max.	80.0 m
Travel distance self-supporting $L_s$ max.	see diagram on page 347
Travel distance vertical, hanging $L_{vh}$ max.	40.0 m
Travel distance vertical, upright $L_{vs}$ max.	3.0 m
Rotated 90°, unsupported $L_{90f}$ max.	1.0 m
Speed, gliding $V_g$ max.	3.0 m/s
Speed, self-supporting $V_s$ max.	10.0 m/s
Acceleration, gliding $a_g$ max.	15.0 m/s <sup>2</sup>
Acceleration, self-supporting $a_s$ max.	20.0 m/s <sup>2</sup>

Contact our engineering department to meet any higher requirements: [efk@murrplastik.de](mailto:efk@murrplastik.de)



## MATERIAL PROPERTIES

Standard material	Polyamide (PA) black
Service temperature	-30.0 – 120.0 °C
Gliding friction factor	0.3
Static friction factor	0.45
Fire classification	Based on UL 94 HB

Other material properties on request.

## SHELVING SYSTEM

### CHAIN BRACKET

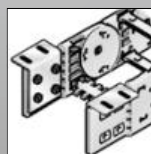

Chain bracket angle

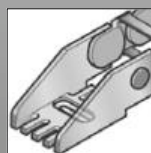

Chain bracket U-part

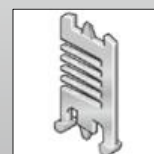

Separator TR



RS shelving system

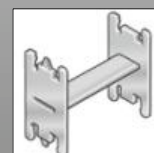

H-shaped shelf unit RE

### GUIDE CHANNELS



VAW steel galvanised / stainless steel



VAW aluminium

**ORDERING KEY**

Type code	Variation	Inside width	Outside width	Inside width	Outside width	Radius	Crossbar variant	Material	Chain length
<b>0350 02</b>	Crossbar on outside bend Crossbar on inside bend Opens on inside bend	<b>062</b> [2.44]	<b>082</b> [3.23]			<b>070</b> [2.76]	<b>0</b> Plastic, full-ridged with bias	<b>0</b> Polyamide standard (PA/black)	
		<b>086</b> [3.39]	<b>106</b> [4.17]						
		<b>102</b> [4.02]	<b>122</b> [4.80]						
		<b>125</b> [4.92]	<b>145</b> [5.71]			<b>100</b> [3.94]	<b>1</b> Plastic, full-ridged without bias	<b>9</b> Special version (on request)	
		<b>150</b> [5.91]	<b>170</b> [6.69]						
						<b>150</b> [5.91]			
						<b>200</b> [7.87]			
						<b>300</b> [11.81]			

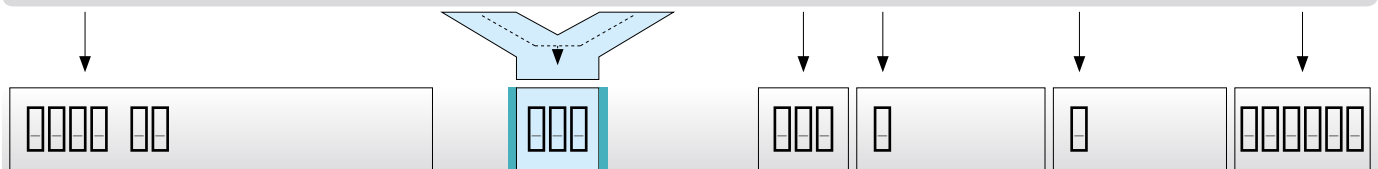

**ORDERING EXAMPLE: 0350 02 062 070 0 0 1276**

Crossbar on outside bend, crossbar on inside bend, can be opened from inside bend  
 Inside width 62 mm; radius 70 mm  
 Plastic crossbar, full-ridged with bias, material black-coloured polyamide  
 Chain length 1276 mm (22 links)

**SELF-SUPPORTING LENGTH**

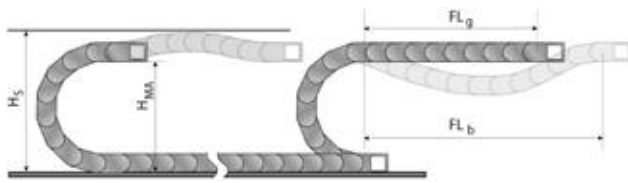

The self-supporting length is the distance between the chain bracket on the moving end and the start of the chain arch.  
 The installation variant  $FL_g$  offers the lowest load and wear for the energy chain.  
 The maximum travel parameters (speed and acceleration) can be applied for this variant.

- $H_s$  = Installation height plus safety
- $H_{MA}$  = Height of moving end connection
- $FL_g$  = Self-supporting length, upper run straight
- $FL_b$  = Self-supporting length, upper run bent

**LOAD DIAGRAM FOR SELF-SUPPORTING APPLICATIONS**

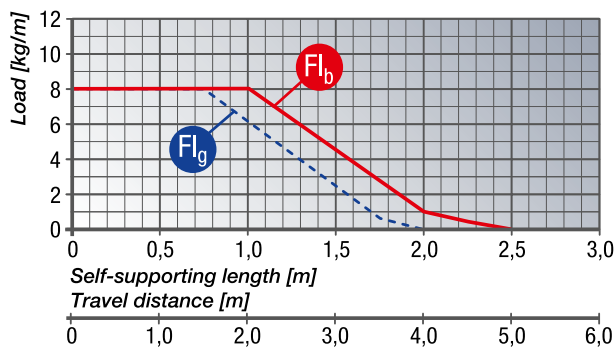

**$FL_g$  Self-supporting length, upper run straight**  
 In the  $FL_g$  range, the chain upper run still has a bias, is straight or has a maximum sag of 60.0 mm.

**$FL_b$  Self-supporting length, upper run bent**  
 In the  $FL_b$  range, the chain upper run has a sag of more than 60.0 mm, but this is still less than the maximum sag. Where the sag is greater than that permitted in the  $FL_b$  range, the application is critical and should be avoided. The self-supporting length can be optimised by using a support for the upper run or a more stable energy chain.

**DETERMINING THE CHAIN LENGTH**

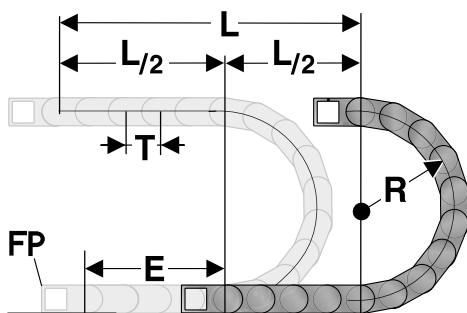

The fixed point of the energy chain should be connected in the middle of the travel distance.  
 This arrangement gives the shortest connection between the fixed point and the moving consumer and thus the most efficient chain length.

Chain length calculation =  $L/2 + \pi * R + 2 * T + E$   
 $\approx 1 \text{ m chain} = 17 \text{ qty. } \times 58.0 \text{ mm.}$

- E = Distance between entry point and middle of travel distance
- L = Travel distance
- R = Radius
- P = Pitch 58.0 mm

**INSTALLATION DIMENSIONS**

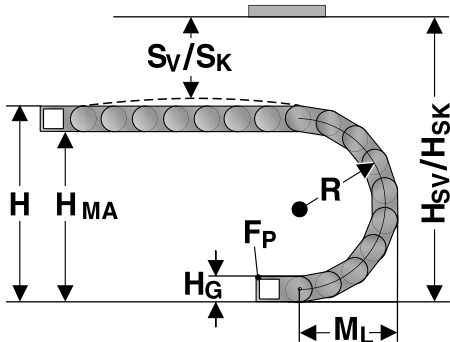

The moving end chain connection is to be screw fixed at height  $H_{MA}$  for the respective radius.

Concerning the installed dimensions, you must take into account whether the chain links are equipped with or without bias.

For chain links without bias, the “Installed height without bias  $H_{SK}$ ” value has to be taken into account.

If the chain links are equipped with a bias, the value “Installed height with bias  $H_{SV}$ ” has to be taken into account.

Radius R	70	100	150	200	300
Outside height of chain link ( $H_G$ )	48	48	48	48	48
Height of bend (H)	188	248	348	448	648
Height of moving end bracket ( $H_{MA}$ )	140	200	300	400	600
Safety margin with bias ( $S_v$ )	40	40	40	40	40
Installation height with bias ( $H_{sv}$ )	228	288	388	488	688
Safety margin without bias ( $S_k$ )	15	15	15	15	15
Installation height without bias ( $H_{sk}$ )	203	263	363	463	663
Arc projection ( $M_L$ )	152	182	232	282	382

**KA 35 CHAIN BRACKET ANGLE**

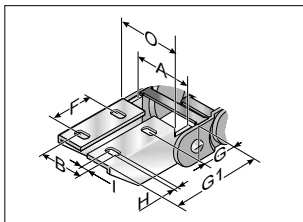

KA 35... (Inside up / down)

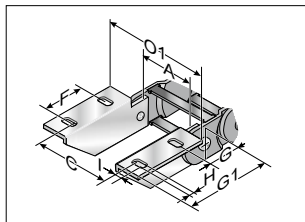

KA 35... (Outside up / down)

The chain bracket can be supplied either in galvanised sheet steel or stainless steel. To secure one energy chain, you will need two angle brackets (left and right) with a drilled hole and two angle brackets (left and right) with a bolt. The order numbers given below each comprise a left and right angle bracket.

Type	Order No.	Material	Inside width							Outside width of KA 0 mm	Outside width of KA 01 mm
			A mm	B mm	C mm	F mm	G mm	HØ mm	I mm		
KA 3508 Female end	0350000054	Sheet steel	62.0 – 150.0	A-7.0	A+28.0	25.0	20.0	7.0	8.0	A+20.0	A+52.0
KA 3508 Male end	0350000055	Sheet steel	62.0 – 150.0	A-12.0	A+38.5	25.0	20.0	7.0	8.0	A+10.0	A+52.0
KA 3509 Female end	0350000056	Stainless steel 1.4301	62.0 – 150.0	A-7.0	A+28.0	25.0	20.0	7.0	8.0	A+20.0	A+52.0
KA 3509 Male end	0350000057	Stainless steel 1.4301	62.0 – 150.0	A-12.0	A+38.5	25.0	20.0	7.0	8.0	A+10.0	A+52.0



**KA 35 CHAIN BRACKET U-PART**

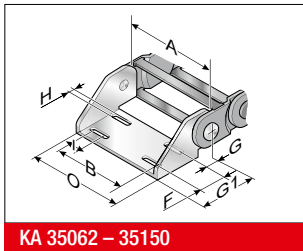

The metal connection (U-section) is precisely adjusted to the respective chain width. It only needs to be snapped in the chain link. Please order one male and one female end bracket for each chain. The brackets should be fastened with M6 screws.

KA 35062 – 35150

Type	Order No.	Material	Inside width A mm	B mm	F mm	G mm	G1 mm	H0 mm	I mm	Outside width of KA 0 mm
KA 35062 Female end	035000007000	Sheet steel	62.0	A-7.0	25.0	20.0	55.0	7.0	15.0	A+20.0
KA 35062 Male end	035000007100	Sheet steel	62.0	A-12.0	25.0	20.0	55.0	7.0	15.0	A+20.0
KA 35086 Female end	035000007200	Sheet steel	86.0	A-7.0	25.0	20.0	55.0	7.0	15.0	A+20.0
KA 35086 Male end	035000007300	Sheet steel	86.0	A-12.0	25.0	20.0	55.0	7.0	15.0	A+20.0
KA 35102 Female end	035000007400	Sheet steel	102.0	A-7.0	25.0	20.0	55.0	7.0	15.0	A+20.0
KA 35102 Male end	035000007500	Sheet steel	102.0	A-12.0	25.0	20.0	55.0	7.0	15.0	A+20.0
KA 35125 Female end	035000007600	Sheet steel	125.0	A-7.0	25.0	20.0	55.0	7.0	15.0	A+20.0
KA 35125 Male end	035000007700	Sheet steel	125.0	A-12.0	25.0	20.0	55.0	7.0	15.0	A+20.0
KA 35150 Female end	035000007800	Sheet steel	150.0	A-7.0	25.0	20.0	55.0	7.0	15.0	A+20.0
KA 35150 Male end	035000007900	Sheet steel	150.0	A-12.0	25.0	20.0	55.0	7.0	15.0	A+20.0
KA 35062 Female end	035000008000	Stainless steel 1.4301	62.0	A-7.0	25.0	20.0	55.0	7.0	15.0	A+20.0
KA 35062 Male end	035000008100	Stainless steel 1.4301	62.0	A-12.0	25.0	20.0	55.0	7.0	15.0	A+20.0
KA 35086 Female end	035000008200	Stainless steel 1.4301	86.0	A-7.0	25.0	20.0	55.0	7.0	15.0	A+20.0
KA 35086 Male end	035000008300	Stainless steel 1.4301	86.0	A-12.0	25.0	20.0	55.0	7.0	15.0	A+20.0
KA 35102 Female end	035000008400	Stainless steel 1.4301	102.0	A-7.0	25.0	20.0	55.0	7.0	15.0	A+20.0
KA 35102 Male end	035000008500	Stainless steel 1.4301	102.0	A-12.0	25.0	20.0	55.0	7.0	15.0	A+20.0
KA 35125 Female end	035000008600	Stainless steel 1.4301	125.0	A-7.0	25.0	20.0	55.0	7.0	15.0	A+20.0
KA 35125 Male end	035000008700	Stainless steel 1.4301	125.0	A-12.0	25.0	20.0	55.0	7.0	15.0	A+20.0
KA 35150 Female end	035000008800	Stainless steel 1.4301	150.0	A-7.0	25.0	20.0	55.0	7.0	15.0	A+20.0
KA 35150 Male end	035000008900	Stainless steel 1.4301	150.0	A-12.0	25.0	20.0	55.0	7.0	15.0	A+20.0

**TR 35 SEPARATOR**

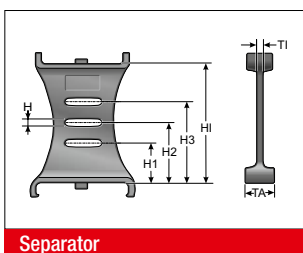

Separator

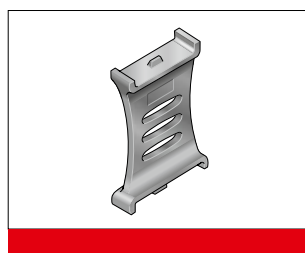

We recommend that separators be used if multiple round cables or conduits with differing diameters are to be installed.

Type	Order No.	Description	Version	T1 mm	TA mm	H mm	H1 mm	H2 mm	H3 mm	HI mm
TR 35	035000009200	Separator	lockable	2.0	13.0	2.5	10.9	16.9	22.9	33.8

**MP 35 SHELVING SYSTEM**

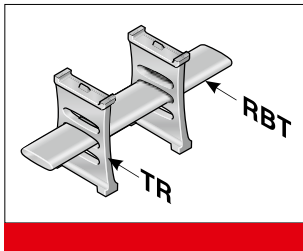

The shelf must be used with a minimum of two separators to create a shelving system. The additional levels prevent cables from criss-crossing and minimise the friction between them. The shelves are matched to the available chain widths.

Type	Order No.	Description	Width mm	Pitch mm
RBT 062	100000006200	Shelf	62.0	3.0
RBT 086	100000008600	Shelf	86.0	3.0
RBT 101	100000010100	Shelf	101.0	3.0
RBT 125	100000012500	Shelf	125.0	3.0
RBT 150	100000015000	Shelf	150.0	3.0

**RE 35 H-SHAPED SHELF UNIT**

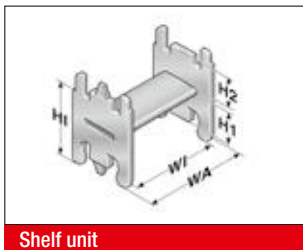

One-piece shelving system, the shelf cannot be varied in height.

Type	Order No.	Description	WA mm	WI mm	H1 mm	H2 mm	HI mm
RE 35/33	100000353310	H-shaped shelf unit	35.5	30.5	18.0	12.0	33.0
RE 35/48	100000354810	H-shaped shelf unit	50.5	45.5	18.0	12.0	33.0
RE 35/57	100000355710	H-shaped shelf unit	59.5	54.5	18.0	12.0	33.0

**GUIDE CHANNEL VAW (ALUMINIUM / STAINLESS STEEL)**



A range of variable guide channel systems, constructed from aluminium or stainless steel sections, are available for this energy chain. The variable guide channel ensures that the energy chain is supported and guided securely.

**ASSEMBLY**

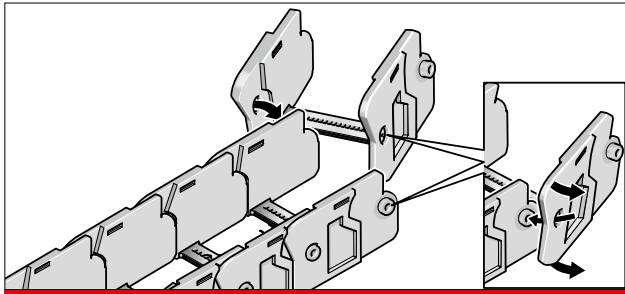

Step 1

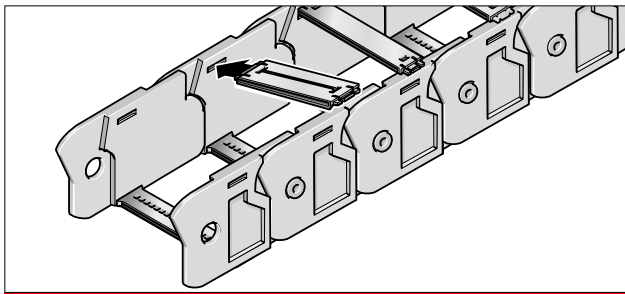

Step 2

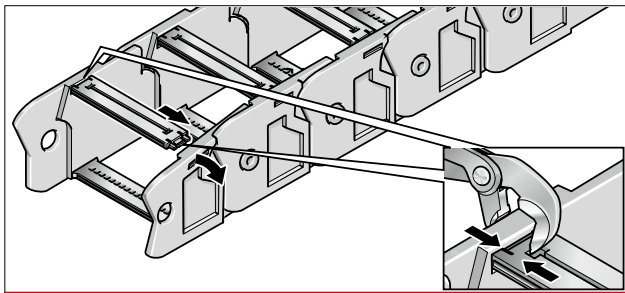

Step 3

**DISASSEMBLY**

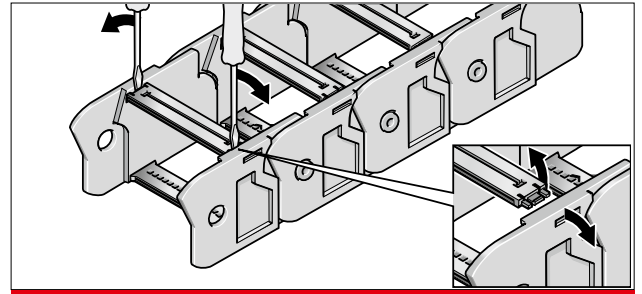

Step 1

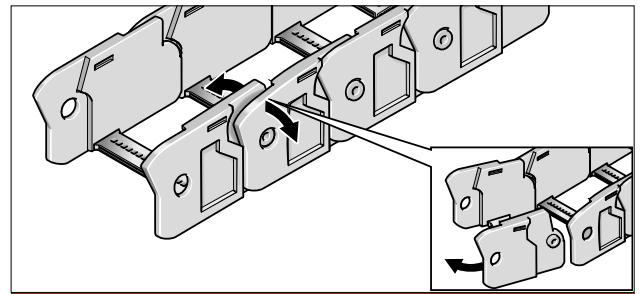

Step 2

## MP 41 OPEN



- PLASTIC OR ALUMINIUM VERSION
- CHAIN BRACKET FLEXIBLE

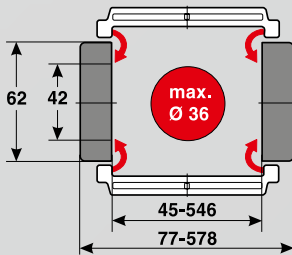

### TECHNICAL DATA

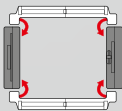

**Loading side**  
Inside and outside bend

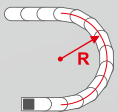

**Available radii**  
90.0 – 350.0 mm

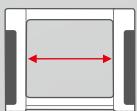

**Available interior widths**  
With plastic crossbar  
45.0 – 546.0 mm  
With alu crossbar / with alu cover  
67.0 – 600.0 mm /

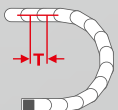

**Pitch**  
T = 77.0 mm

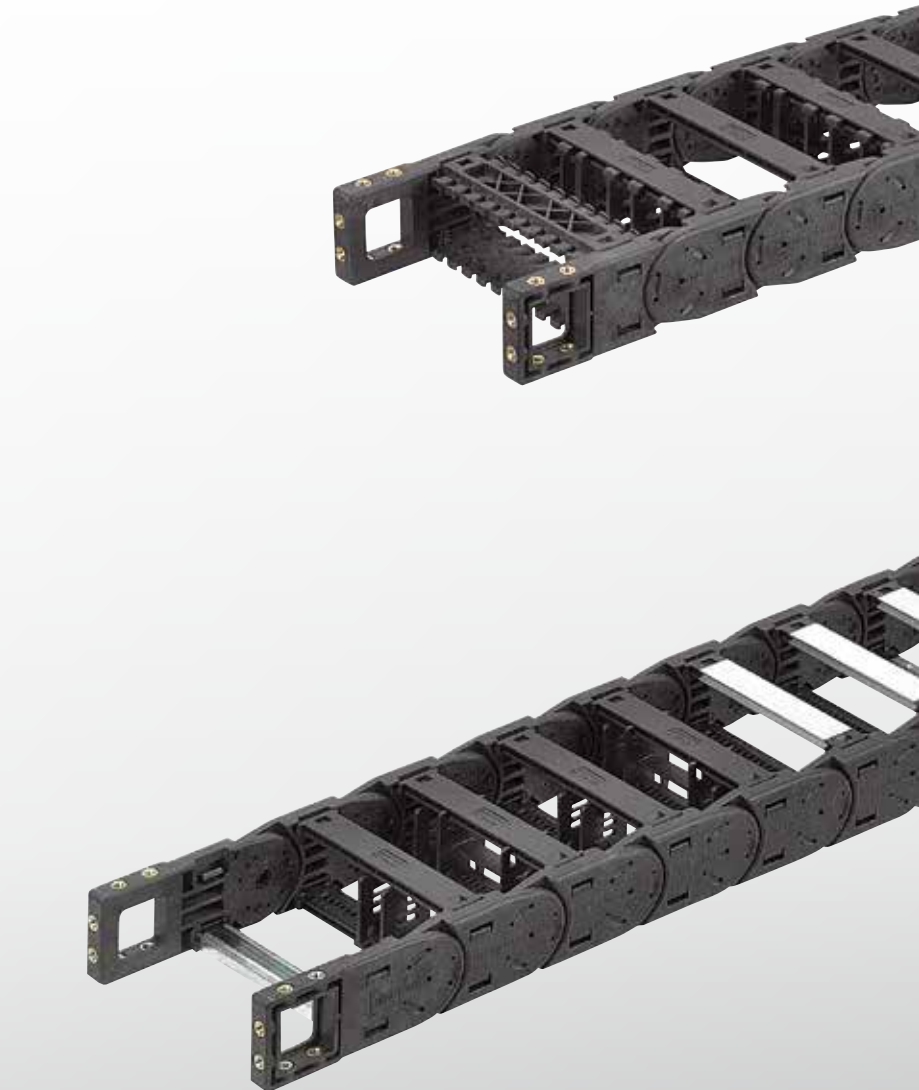



## TECHNICAL SPECIFICATIONS

Travel distance gliding $L_g$ max.	120.0 m
Travel distance self-supporting $L_s$ max.	see diagram on page 355
Travel distance vertical, hanging $L_{vh}$ max.	50.0 m
Travel distance vertical, upright $L_{vs}$ max.	6.0 m
Rotated 90°, unsupported $L_{90f}$ max.	2.0 m
Speed, gliding $V_g$ max.	5.0 m/s
Speed, self-supporting $V_f$ max.	20.0 m/s
Acceleration, gliding $a_g$ max.	25.0 m/s <sup>2</sup>
Acceleration, self-supporting $a_s$ max.	30.0 m/s <sup>2</sup>

Contact our engineering department to meet any higher requirements: [efk@murrplastik.de](mailto:efk@murrplastik.de)

## MATERIAL PROPERTIES

Standard material	Polyamide (PA) black
Service temperature	-30.0 – 120.0 °C
Gliding friction factor	0.3
Static friction factor	0.45
Fire classification	UL 94 HB

Other material properties on request.

### SHELVING SYSTEM



Separator TR

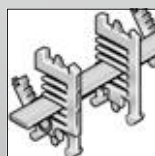

RS shelving system

### CHAIN BRACKET

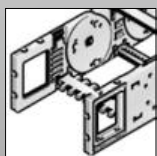

Chain bracket flexible

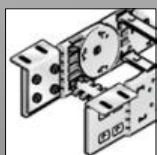

Chain bracket angle



Crossbar connector RSV

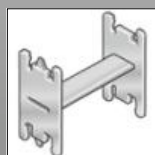

H-shaped shelf unit RE

### ACCESSORIES



Bracket bar

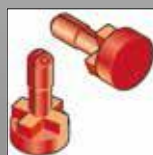

Lock button

### GUIDE CHANNELS



VAW steel galvanised / stainless steel

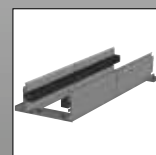

VAW aluminium

### STRAIN RELIEF

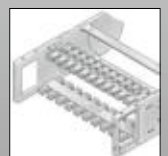

RS-ZL crossbar strain relief



STF Steel Fix

ORDERING KEY

Type code	Variation	Inside width	Outside width	Inside width	Outside width	Radius	Crossbar variant	Material	Chain length																																																																																																																								
0410 30	Crossbar on outside bend Crossbar on inside bend Opens on inside and outside bend	045 [1.77]	077 [3.03]	233 [9.17]	265 [10.43]	090 [3.54]	0 Plastic, full-ridged with bias	0 Polyamide standard (PA/black)																																																																																																																									
		057 [2.24]	089 [3.50]	246 [9.69]	278 [10.94]							062 [2.44]	094 [3.70]	252 [9.92]	284 [11.18]	120 [4.72]	2 Plastic, half-ridged with bias	9 Special version (on request)		071 [2.80]	103 [4.06]	258 [10.16]	290 [11.42]			084 [3.31]	116 [4.57]	296 [11.65]	328 [12.91]	150 [5.91]	4 Aluminium full-ridged with bias			093 [3.66]	125 [4.92]	346 [13.62]	378 [14.88]			096 [3.78]	128 [5.04]	350 [13.78]	382 [15.04]	200 [7.87]	6 Aluminium half-ridged with bias			104 [4.09]	136 [5.35]	358 [14.09]	390 [15.35]			107 [4.21]	139 [5.47]	371 [14.61]	403 [15.87]	250 [9.84]	9 Special version (on request)			121 [4.76]	153 [6.02]	396 [15.59]	428 [16.85]			133 [5.24]	165 [6.50]	421 [16.57]	453 [17.83]	300 [11.81]				144 [5.67]	176 [6.93]	446 [17.56]	478 [18.82]			146 [5.75]	178 [7.01]	496 [19.53]	528 [20.79]	350 [13.78]				158 [6.22]	190 [7.48]	546 [21.50]	578 [22.76]			164 [6.46]	196 [7.72]							171 [6.73]	203 [7.99]					182 [7.17]	214 [8.43]							196 [7.72]	228 [8.98]					208 [8.19]	240 [9.45]				
		062 [2.44]	094 [3.70]	252 [9.92]	284 [11.18]	120 [4.72]	2 Plastic, half-ridged with bias	9 Special version (on request)																																																																																																																									
		071 [2.80]	103 [4.06]	258 [10.16]	290 [11.42]							084 [3.31]	116 [4.57]	296 [11.65]	328 [12.91]	150 [5.91]	4 Aluminium full-ridged with bias			093 [3.66]	125 [4.92]	346 [13.62]	378 [14.88]			096 [3.78]	128 [5.04]	350 [13.78]	382 [15.04]	200 [7.87]	6 Aluminium half-ridged with bias			104 [4.09]	136 [5.35]	358 [14.09]	390 [15.35]			107 [4.21]	139 [5.47]	371 [14.61]	403 [15.87]	250 [9.84]	9 Special version (on request)			121 [4.76]	153 [6.02]	396 [15.59]	428 [16.85]			133 [5.24]	165 [6.50]	421 [16.57]	453 [17.83]	300 [11.81]				144 [5.67]	176 [6.93]	446 [17.56]	478 [18.82]			146 [5.75]	178 [7.01]	496 [19.53]	528 [20.79]	350 [13.78]				158 [6.22]	190 [7.48]	546 [21.50]	578 [22.76]			164 [6.46]	196 [7.72]							171 [6.73]	203 [7.99]					182 [7.17]	214 [8.43]							196 [7.72]	228 [8.98]					208 [8.19]	240 [9.45]							220 [8.66]	252 [9.92]										
		084 [3.31]	116 [4.57]	296 [11.65]	328 [12.91]	150 [5.91]	4 Aluminium full-ridged with bias																																																																																																																										
		093 [3.66]	125 [4.92]	346 [13.62]	378 [14.88]							096 [3.78]	128 [5.04]	350 [13.78]	382 [15.04]	200 [7.87]	6 Aluminium half-ridged with bias			104 [4.09]	136 [5.35]	358 [14.09]	390 [15.35]			107 [4.21]	139 [5.47]	371 [14.61]	403 [15.87]	250 [9.84]	9 Special version (on request)			121 [4.76]	153 [6.02]	396 [15.59]	428 [16.85]			133 [5.24]	165 [6.50]	421 [16.57]	453 [17.83]	300 [11.81]				144 [5.67]	176 [6.93]	446 [17.56]	478 [18.82]			146 [5.75]	178 [7.01]	496 [19.53]	528 [20.79]	350 [13.78]				158 [6.22]	190 [7.48]	546 [21.50]	578 [22.76]			164 [6.46]	196 [7.72]							171 [6.73]	203 [7.99]					182 [7.17]	214 [8.43]							196 [7.72]	228 [8.98]					208 [8.19]	240 [9.45]							220 [8.66]	252 [9.92]																								
		096 [3.78]	128 [5.04]	350 [13.78]	382 [15.04]	200 [7.87]	6 Aluminium half-ridged with bias																																																																																																																										
		104 [4.09]	136 [5.35]	358 [14.09]	390 [15.35]							107 [4.21]	139 [5.47]	371 [14.61]	403 [15.87]	250 [9.84]	9 Special version (on request)			121 [4.76]	153 [6.02]	396 [15.59]	428 [16.85]			133 [5.24]	165 [6.50]	421 [16.57]	453 [17.83]	300 [11.81]				144 [5.67]	176 [6.93]	446 [17.56]	478 [18.82]			146 [5.75]	178 [7.01]	496 [19.53]	528 [20.79]	350 [13.78]				158 [6.22]	190 [7.48]	546 [21.50]	578 [22.76]			164 [6.46]	196 [7.72]							171 [6.73]	203 [7.99]					182 [7.17]	214 [8.43]							196 [7.72]	228 [8.98]					208 [8.19]	240 [9.45]							220 [8.66]	252 [9.92]																																						
		107 [4.21]	139 [5.47]	371 [14.61]	403 [15.87]	250 [9.84]	9 Special version (on request)																																																																																																																										
		121 [4.76]	153 [6.02]	396 [15.59]	428 [16.85]							133 [5.24]	165 [6.50]	421 [16.57]	453 [17.83]	300 [11.81]				144 [5.67]	176 [6.93]	446 [17.56]	478 [18.82]			146 [5.75]	178 [7.01]	496 [19.53]	528 [20.79]	350 [13.78]				158 [6.22]	190 [7.48]	546 [21.50]	578 [22.76]			164 [6.46]	196 [7.72]							171 [6.73]	203 [7.99]					182 [7.17]	214 [8.43]							196 [7.72]	228 [8.98]					208 [8.19]	240 [9.45]							220 [8.66]	252 [9.92]																																																				
		133 [5.24]	165 [6.50]	421 [16.57]	453 [17.83]	300 [11.81]																																																																																																																											
		144 [5.67]	176 [6.93]	446 [17.56]	478 [18.82]							146 [5.75]	178 [7.01]	496 [19.53]	528 [20.79]	350 [13.78]				158 [6.22]	190 [7.48]	546 [21.50]	578 [22.76]			164 [6.46]	196 [7.72]							171 [6.73]	203 [7.99]					182 [7.17]	214 [8.43]							196 [7.72]	228 [8.98]					208 [8.19]	240 [9.45]							220 [8.66]	252 [9.92]																																																																		
		146 [5.75]	178 [7.01]	496 [19.53]	528 [20.79]	350 [13.78]																																																																																																																											
		158 [6.22]	190 [7.48]	546 [21.50]	578 [22.76]							164 [6.46]	196 [7.72]							171 [6.73]	203 [7.99]					182 [7.17]	214 [8.43]							196 [7.72]	228 [8.98]					208 [8.19]	240 [9.45]							220 [8.66]	252 [9.92]																																																																																
		164 [6.46]	196 [7.72]																																																																																																																														
		171 [6.73]	203 [7.99]									182 [7.17]	214 [8.43]							196 [7.72]	228 [8.98]					208 [8.19]	240 [9.45]							220 [8.66]	252 [9.92]																																																																																														
		182 [7.17]	214 [8.43]																																																																																																																														
		196 [7.72]	228 [8.98]									208 [8.19]	240 [9.45]							220 [8.66]	252 [9.92]																																																																																																												
		208 [8.19]	240 [9.45]																																																																																																																														
		220 [8.66]	252 [9.92]																																																																																																																														

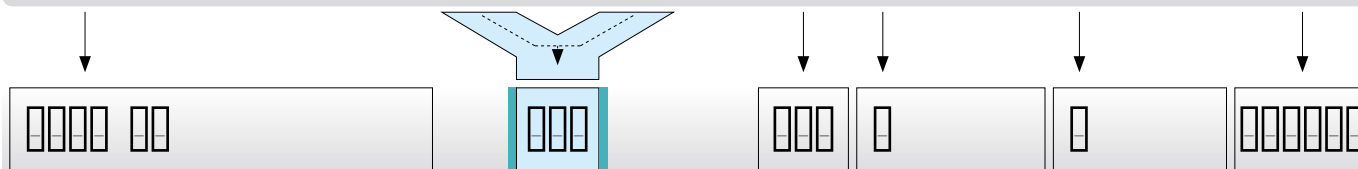

ORDERING EXAMPLE: 0410 30 045 090 0 0 1386

Crossbar on outside bend, crossbar on inside bend, can be opened from inside and outside bend  
 Inside width 45 mm; radius 90 mm  
 Plastic crossbar, full-ridged with bias, material black-coloured polyamide  
 Chain length 1386 mm (18 links)

**NOTE ON CONFIGURATION**

**Aluminium crossbars:**

Aluminium crossbars can be supplied in 1 mm width sizes for inner widths from 67.0 mm – 600.0 mm .

**Crossbar connector and crossbar strain relief plate:**

Once inside widths exceed 246 mm, we recommend the deployment of crossbar connectors (RSV).

If crossbar strain relief plates (RS-ZL) are to be deployed in the chain brackets, take standard inside widths into account.

For detailed information, please consult the corresponding product documentation.

**SELF-SUPPORTING LENGTH**

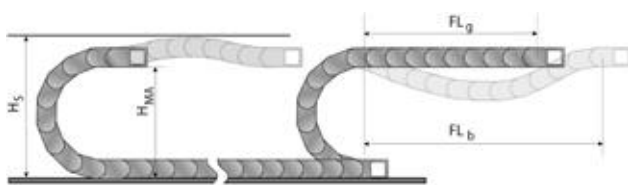

The self-supporting length is the distance between the chain bracket on the moving end and the start of the chain arch. The installation variant  $FL_g$  offers the lowest load and wear for the energy chain. The maximum travel parameters (speed and acceleration) can be applied for this variant.

- $H_s$  = Installation height plus safety
- $H_{MA}$  = Height of moving end connection
- $FL_g$  = Self-supporting length, upper run straight
- $FL_b$  = Self-supporting length, upper run bent

**LOAD DIAGRAM FOR SELF-SUPPORTING APPLICATIONS**

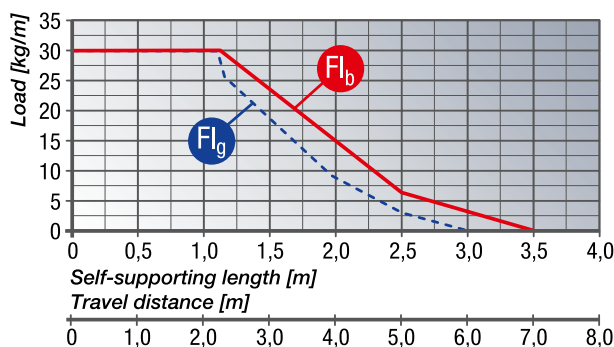

**$FL_g$  Self-supporting length, upper run straight**

In the  $FL_g$  range, the chain upper run still has a bias, is straight or has a maximum sag of 70.0 mm.

**$FL_b$  Self-supporting length, upper run bent**

In the  $FL_b$  range, the chain upper run has a sag of more than 70.0 mm, but this is still less than the maximum sag. Where the sag is greater than that permitted in the  $FL_b$  range, the application is critical and should be avoided. The self-supporting length can be optimised by using a support for the upper run or a more stable energy chain.

**DETERMINING THE CHAIN LENGTH**

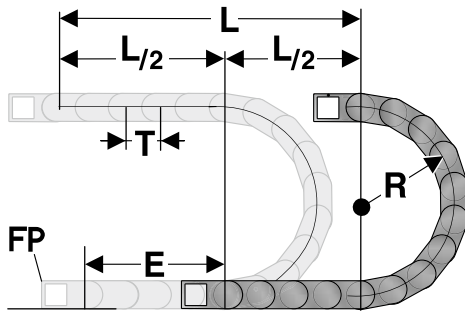

The fixed point of the energy chain should be connected in the middle of the travel distance.  
 This arrangement gives the shortest connection between the fixed point (FP) and the moving consumer and thus the most efficient chain length.

Chain length calculation =  $L/2 + \pi * R + E$   
 $\approx 1 \text{ m chain} = 13 \text{ qty. x77.0 mm.}$

- E = Distance between entry point and middle of travel distance
- L = Travel distance
- R = Radius
- P = Pitch 77.0 mm

**INSTALLATION DIMENSIONS**

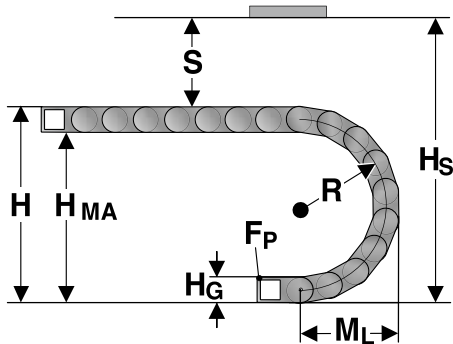

The moving end chain connection is to be screw fixed at height  $H_{MA}$  for the respective radius.  
 For the installed dimension the "Installed height  $H_S$ " value has to be taken into account.

Radius R	90	120	150	200	250	300	350
Outside height of chain link ( $H_o$ )	62	62	62	62	62	62	62
Height of bend (H)	252	312	372	472	572	672	772
Height of moving end bracket ( $H_{MA}$ )	190	250	310	410	510	610	710
Safety margin (S)	30	30	30	30	30	30	30
Installation height ( $H_s$ )	282	342	402	502	602	702	802
Arc projection ( $M_L$ )	203	233	263	313	363	413	463



## POWERLINE PLASTIC CROSSBAR



Crossbar

The crossbars connect the two side runs of the energy chain.  
The crossbar length is synonymous with the inside width of the energy chain.

Type	Order No.	Description	Inside width mm
RS 045-5	052004500000	Crossbar	45.0
RS 057-5	052005700000	Crossbar	57.0
RS 062-5	052006200000	Crossbar	62.0
RS 071-5	052007100000	Crossbar	71.0
RS 084-5	052008400000	Crossbar	84.0
RS 093-5	052009300000	Crossbar	93.0
RS 096-5	052009600000	Crossbar	96.0
RS 104-5	052010400000	Crossbar	104.0
RS 107-5	052010700000	Crossbar	107.0
RS 121-5	052012100000	Crossbar	121.0
RS 133-5	052013300000	Crossbar	133.0
RS 144-5	052014400000	Crossbar	144.0
RS 146-5	052014600000	Crossbar	146.0
RS 158-5	052015800000	Crossbar	158.0
RS 164-5	052016400000	Crossbar	164.0
RS 171-5	052017100000	Crossbar	171.0
RS 182-5	052018200000	Crossbar	182.0
RS 196-5	052019600000	Crossbar	196.0
RS 208-5	052020800000	Crossbar	208.0
RS 220-5	052022000000	Crossbar	220.0
RS 233-5	052023300000	Crossbar	233.0
RS 246-5	052024600000	Crossbar	246.0
RS 252-5	052025200010	Crossbar	252.0
RS 258-5	052025800000	Crossbar	258.0
RS 296-5	052029600000	Crossbar	296.0
RS 346-5	052034600000	Crossbar	346.0
RS 350-5	052035000000	Crossbar	350.0
RS 358-5	052035800000	Crossbar	358.0
RS 371-5	052037100000	Crossbar	371.0
RS 396-5	052039600000	Crossbar	396.0
RS 421-5	052042100000	Crossbar	421.0
RS 446-5	052044600000	Crossbar	446.0
RS 496-5	052049600000	Crossbar	496.0
RS 546-5	052054600000	Crossbar	546.0

**KA 41 CHAIN BRACKET FLEXIBLE**

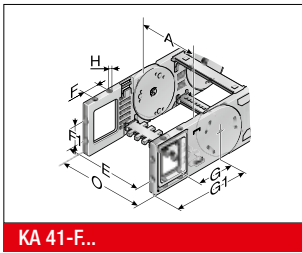

This chain bracket offers universal connection options (top, bottom and front) and is attached to the ends of the chain like a side link. This allows the chain to move right up to the bracket. Each chain requires one male and one female bracket. M6 bolts are used to secure the brackets in place. Extrusion-coated metal bushes with either a through-hole (-FB) or a threaded hole (-FG) ensure the permanent, high-strength transmission of even extreme forces onto the energy chain.

Type	Order No.	Material	Version	Inside width								Outside width of KA 0 mm
				A mm	E mm	F mm	F1 mm	G mm	G1 mm	H mm	H0 mm	
KA 41.1-FB	0411000054	Plastic	with bush	45.0 – 546.0	A+20.0	22.5	22.0	79.0	120.0		6.5	A+34.0
KA 41.1-FG	0411000055	Plastic	with thread	45.0 – 546.0	A+20.0	22.5	22.0	79.0	120.0	M6		A+34.0

**KA 41 CHAIN BRACKET ANGLE**

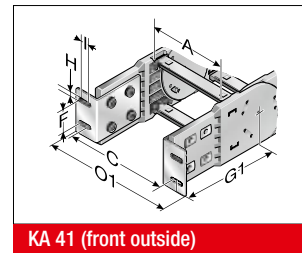
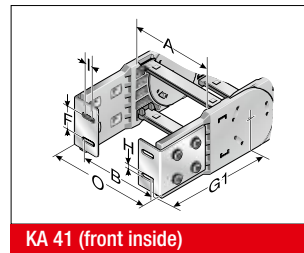
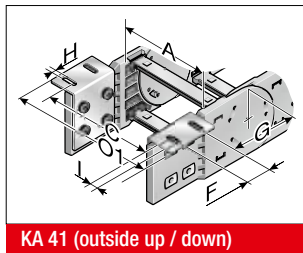
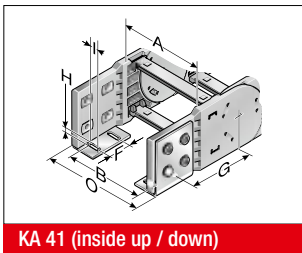

There are several options regarding the chain bracket. The fixed-point bracket (inside/bottom) and the moving end bracket (inside/top) are supplied as standard. However, any other combination can be supplied upon request. The chain bracket is fas-

tened at the end like a side link. This enables the chain to move right up to the bracket. Each chain requires two chain brackets. The brackets should be fastened with M6 screws.

Type	Order No.	Material	Inside width						Outside width of KA 0 mm	Outside width of KA 01 mm	
			A mm	B mm	C mm	F mm	G mm	G1 mm			H0 mm
KA 41	0410000051	Sheet steel	45.0 – 546.0	A-2.5	A+34.5	32.0	79.0	125.7	6.5	A+32.0	A+71.0

**TR 41 SEPARATOR**

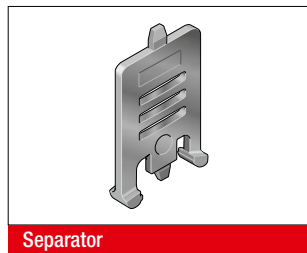
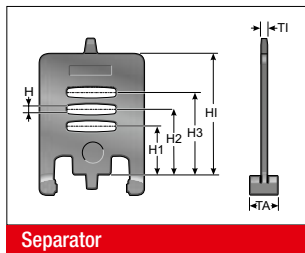

We recommend that separators be used if multiple round cables or conduits with differing diameters are to be installed.

Type	Order No.	Description	Version	TI mm	TA mm	H mm	H1 mm	H2 mm	H3 mm	HI mm
TR 41	041000009200	Separator	lockable	3.5	10.0	4.2	16.1	22.9	28.9	42.0

**TR 41.1 SEPARATOR**

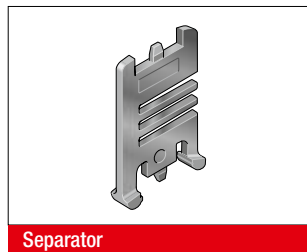
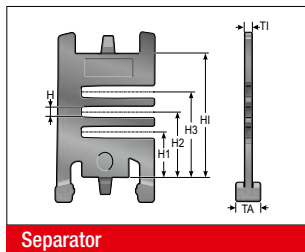

We recommend that separators be used if multiple round cables or conduits with differing diameters are to be installed.

Type	Order No.	Description	Version	TI mm	TA mm	H mm	H1 mm	H2 mm	H3 mm	HI mm
TR 41.1	041200009200	Separator	lockable	3.5	8.0	4.0	16.1	22.9	28.9	42.0

**TR 41-V SEPARATOR**

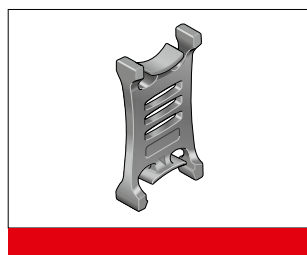
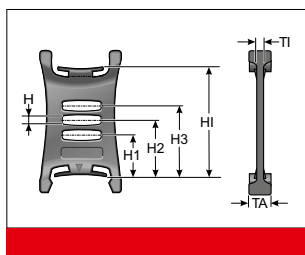

We recommend that separators be used if multiple round cables or conduits with differing diameters are to be installed.

Type	Order No.	Description	Version	TI mm	TA mm	H mm	H1 mm	H2 mm	H3 mm	HI mm
TR 41-V	041000009300	Separator	moveable	3.5	12.0	4.0	16.1	22.9	28.9	42.0

**RTT 41 SHELF SUPPORT, DIVISIBLE**

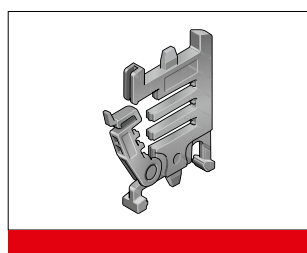
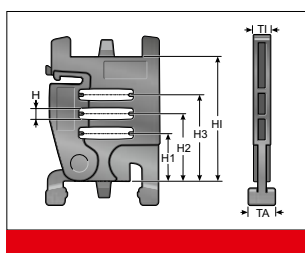

In connection with two separable shelf supports (RTT) with at least one end-to-end shelf (RB) the shelf becomes an easy to fill shelving system. The additional levels prevent cables from criss-crossing and minimise the friction between them.

Type	Order No.	Description	Version	TI mm	TA mm	H mm	H1 mm	H2 mm	H3 mm	HI mm
RTT 41	100090412000	Shelf support, divisible	lockable	7.0	8.0	4.0	16.1	22.9	28.9	42.0

## RB-5 SHELF

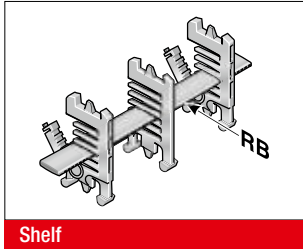

In connection with at least two separable shelf supports (RTT), the shelf becomes a shelving system. The additional levels prevent cables from criss-crossing and minimise the friction between them.

Type	Order No.	Description	Width mm	Inside width mm
RB 028-5	10000002800	Shelf	28.0	45.0
RB 034-5	1000003405	Shelf	33.6	45.0
RB 039-5	1000003905	Shelf	39.2	45.0
RB 045-5	1000004505	Shelf	44.8	57.0
RB 050-5	1000005005	Shelf	50.4	57.0
RB 056-5	10000005601	Shelf	56.0	62.0
RB 062-5	1000006205	Shelf	61.6	62.0
RB 067-5	1000006705	Shelf	67.2	84.0
RB 073-5	1000007305	Shelf	72.8	84.0
RB 078-5	1000007805	Shelf	78.4	84.0
RB 084-5	10000008400	Shelf	84.0	84.0
RB 090-5	1000009005	Shelf	89.6	96.0
RB 095-5	1000009505	Shelf	95.2	96.0
RB 101-5	1000010105	Shelf	100.8	107.0
RB 106-5	1000010605	Shelf	106.4	107.0
RB 112-5	100000011200	Shelf	112.0	121.0
RB 118-5	1000011805	Shelf	117.6	121.0
RB 123-5	1000012305	Shelf	123.2	133.0
RB 129-5	1000012905	Shelf	128.8	133.0
RB 134-5	1000013405	Shelf	134.4	144.0
RB 140-5	100000014000	Shelf	140.0	144.0
RB 146-5	1000014605	Shelf	145.6	158.0
RB 151-5	1000015105	Shelf	151.2	158.0
RB 157-5	1000015705	Shelf	156.8	164.0
RB 162-5	1000016205	Shelf	162.4	164.0
RB 168-5	100000016800	Shelf	168.0	182.0
RB 174-5	1000017405	Shelf	173.6	182.0
RB 179-5	1000017905	Shelf	179.2	196.0
RB 185-5	1000018505	Shelf	184.8	196.0
RB 190-5	1000019005	Shelf	190.4	196.0
RB 196-5	100000019600	Shelf	196.0	196.0
RB 291-5	100000029100	Shelf	291.2	346.0

**RSV 41 CROSSBAR CONNECTOR**

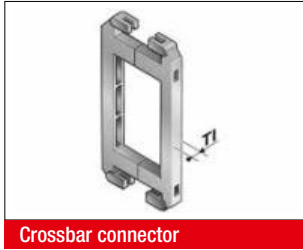

For crossbars wider than 246 mm, we recommend the use of crossbar connectors. These prevent deformation to the crossbar under large amounts of additional weight of the chain assembly.

Type	Order No.	Description	T1 mm
RSV 41	041000009600	Crossbar connector	7.5
RSV 41 Alu	041000009800	Crossbar connector for aluminium crossbars	7.5

**RE 41 H-SHAPED SHELF UNIT**

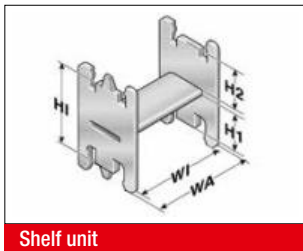

One-piece shelving system, the shelf cannot be varied in height.

Type	Order No.	Description	WA mm	WI mm	H1 mm	H2 mm	HI mm
RE 36/11	100000361112	H-shaped shelf unit	42.5	36.5	26.2	11.5	42.0
RE 59/18	100000591812	H-shaped shelf unit	65.0	59.0	18.8	18.8	42.0
RE 81/11	100000811112	H-shaped shelf unit	87.5	81.5	26.2	11.5	42.0

**BS-5 BRACKET BAR**



Large-diameter conduits are routed securely by using a bracket bar (BS). This bar is installed on the crossbars or the covers of the energy chain.

The bracket bar can be installed on both the inside and outside bend.

The bracket bar support (BSH) is used to attach the bars to PowerLine series crossbars. Two bracket bar supports are required for each bar.

Type	Order No.	Description	Conduit diameter max. mm	Installation height mm	Inner chain width min. mm
BS 120-5	052412000000	Bracket bar	115.0	140.0	164.0
BS 153-5	052415300000	Bracket bar	148.0	170.0	208.0
BS 187-5	052418700000	Bracket bar	182.0	205.0	233.0
BSH-5	052400000000	Bracket bar support			
Assembly set	052400000001	Assembly set			

## RS-ZL-5 CROSSBAR STRAIN RELIEF PLATE

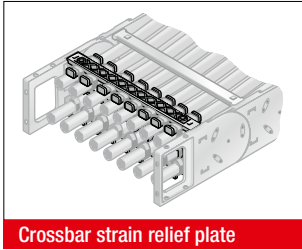

Crossbar strain relief plate

Fixed integrated frame bridge strain relief plates in the chain brackets. Tailored to all crossbar widths up to 246 mm. May be assembled on the inside and outside bends at both chain endings.

Type	Order No.	Description	Inside width mm
RS-ZL 045-5	052004500010	Crossbar strain relief plate	45.0
RS-ZL 057-5	052005700010	Crossbar strain relief plate	57.0
RS-ZL 062-5	052006200010	Crossbar strain relief plate	62.0
RS-ZL 071-5	052007100010	Crossbar strain relief plate	71.0
RS-ZL 084-5	052008400010	Crossbar strain relief plate	84.0
RS-ZL 093-5	052009300010	Crossbar strain relief plate	93.0
RS-ZL 096-5	052009600010	Crossbar strain relief plate	96.0
RS-ZL 104-5	052010400010	Crossbar strain relief plate	104.0
RS-ZL 107-5	052010700010	Crossbar strain relief plate	107.0
RS-ZL 121-5	052012100010	Crossbar strain relief plate	121.0
RS-ZL 133-5	052013300010	Crossbar strain relief plate	133.0
RS-ZL 144-5	052014400010	Crossbar strain relief plate	144.0
RS-ZL 146-5	052014600010	Crossbar strain relief plate	146.0
RS-ZL 158-5	052015800010	Crossbar strain relief plate	158.0
RS-ZL 164-5	052016400010	Crossbar strain relief plate	164.0
RS-ZL 171-5	052017100010	Crossbar strain relief plate	171.0
RS-ZL 182-5	052018200010	Crossbar strain relief plate	182.0
RS-ZL 196-5	052019600010	Crossbar strain relief plate	196.0
RS-ZL 208-5	052020800010	Crossbar strain relief plate	208.0
RS-ZL 220-5	052022000010	Crossbar strain relief plate	220.0
RS-ZL 233-5	052023300010	Crossbar strain relief plate	233.0
RS-ZL 246-5	052024600010	Crossbar strain relief plate	246.0

**STRAIN RELIEF WITH STEEL FIX**

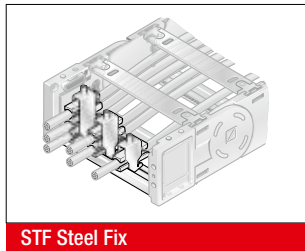
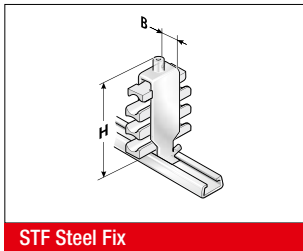

C-rails (galvanised) for permanent integration, for accommodating the Steel Fix bow clamps in the chain brackets. The bow clamps can take up to 3 cables and are suitable for C-rails with a groove width of 11 mm. Due to the design of the trough elements, a cable preserving cable guidance is ensured. May be assembled on the inside and outside bends at both chain endings. The overall height stated is a guide only. The actual height is, amongst other things, dependent on the diameter and the quality of the cable. A safety distance of 10 mm at the fixed point above the strain relief must be kept during gliding applications.

Type	Order No.	Description	Seats qty.	Cable Ø mm	Width mm	Total height (H) mm
<b>Single clamp (for one cable)</b>						
STF 12-1 Steel Fix	81661801	Hooped clamp	1	6.0 – 12.0	16.0	55.0
STF 14-1 Steel Fix	81661802	Hooped clamp	1	12.0 – 14.0	18.0	52.0
STF 16-1 Steel Fix	81661803	Hooped clamp	1	14.0 – 16.0	20.0	54.0
STF 18-1 Steel Fix	81661804	Hooped clamp	1	16.0 – 18.0	22.0	56.0
STF 20-1 Steel Fix	81661805	Hooped clamp	1	18.0 – 20.0	24.0	59.0
STF 22-1 Steel Fix	81661806	Hooped clamp	1	20.0 – 22.0	26.0	61.0
STF 26-1 Steel Fix	81661807	Hooped clamp	1	22.0 – 26.0	30.0	70.0
STF 30-1 Steel Fix	81661808	Hooped clamp	1	26.0 – 30.0	34.0	74.0
STF 34-1 Steel Fix	81661809	Hooped clamp	1	30.0 – 34.0	38.0	78.0
STF 38-1 Steel Fix	81661810	Hooped clamp	1	34.0 – 38.0	42.0	82.0
STF 42-1 Steel Fix	81661811	Hooped clamp	1	38.0 – 42.0	46.0	91.0
<b>Double clamp (for two cables)</b>						
STF 12-2 Steel Fix	81661821	Hooped clamp	2	6.0 – 12.0	16.0	73.0
STF 14-2 Steel Fix	81661822	Hooped clamp	2	12.0 – 14.0	18.0	74.0
STF 16-2 Steel Fix	81661823	Hooped clamp	2	14.0 – 16.0	20.0	82.0
STF 18-2 Steel Fix	81661824	Hooped clamp	2	16.0 – 18.0	22.0	86.0
STF 20-2 Steel Fix	81661825	Hooped clamp	2	18.0 – 20.0	24.0	91.0
STF 22-2 Steel Fix	81661826	Hooped clamp	2	20.0 – 22.0	26.0	95.0
STF 26-2 Steel Fix	81661827	Hooped clamp	2	22.0 – 26.0	30.0	108.0
STF 30-2 Steel Fix	81661828	Hooped clamp	2	26.0 – 30.0	34.0	121.0
STF 34-2 Steel Fix	81661829	Hooped clamp	2	30.0 – 34.0	38.0	129.0
<b>Triple clamp (for three cables)</b>						
STF 12-3 Steel Fix	81661841	Hooped clamp	3	6.0 – 12.0	16.0	98.0
STF 14-3 Steel Fix	81661842	Hooped clamp	3	12.0 – 14.0	18.0	98.0
STF 16-3 Steel Fix	81661843	Hooped clamp	3	14.0 – 16.0	20.0	105.0
STF 18-3 Steel Fix	81661844	Hooped clamp	3	16.0 – 18.0	22.0	111.0
STF 20-3 Steel Fix	81661845	Hooped clamp	3	18.0 – 20.0	24.0	118.0
STF 22-3 Steel Fix	81661846	Hooped clamp	3	20.0 – 22.0	26.0	130.0

**MP 32/41 LOCK BUTTON**

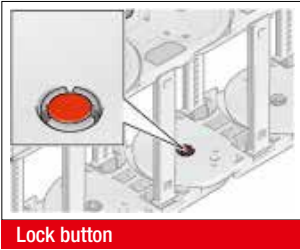

Lock button

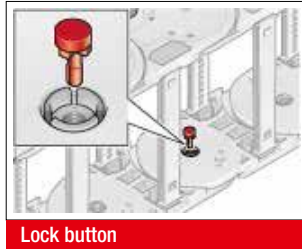

Lock button

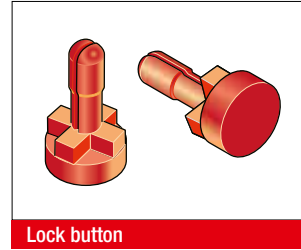

Lock button

To increase the side stability, we recommend the use of lock buttons during strong lateral acceleration or when installed

“laying on the side (turned 90°) without support”.

Type	Order No.
MP32/41 lock button	04100008000

**MP 41 LOWERED FIXING POINT**

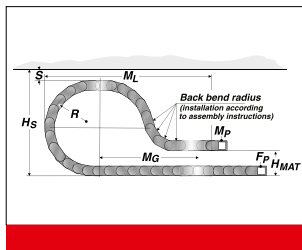
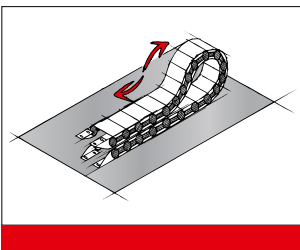

It is sometimes necessary to lower the height of the moving attachment point.

In such cases, modifications to the chain layout should be noted (e.g. extension of chain).

Please contact our application engineers.

Radius R mm	Height of moving end bracket (H <sub>MA</sub> ) mm	Safety margin (S) mm	Installation height incl. safety (H <sub>s</sub> ) mm	Projection (M <sub>L</sub> ) mm	Additional links qty.	of which additional back chain links qty.
175.0	160.0	50.0	472.0	640.0	6	2
200.0	190.0	50.0	522.0	770.0	13	2
250.0	220.0	50.0	622.0	910.0	15	2
300.0	280.0	50.0	722.0	1180.0	19	2
350.0	320.0	50.0	822.0	1140.0	19	3

**MP 41 REARWARD RADII**

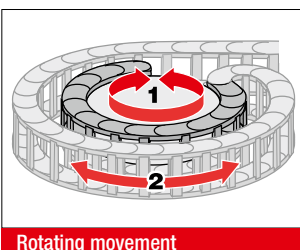

Rotating movement

Side links with rearward radius allow movements in both directions. This is intended for rotating movements and lowered chain brackets. Rotation movements are only possible with open variants.

Type	Order No.	Radius mm	Rearward radius mm
SR 41 (RÜ200/R125)	04100009060	125.0	200.0
SR 41 (RÜ200/R160)	041000012060	160.0	200.0
SR 41 (RÜ200/R175)	041000015060	175.0	200.0
SR 41 (RÜ200/R200)	041000020060	200.0	200.0
SR 41 (RÜ200/R250)	041000025060	250.0	200.0
SR 41 (RÜ200/R300)	041000030060	300.0	200.0
SR 41 (RÜ200/R350)	041000035060	350.0	200.0



**GUIDE CHANNEL VAW (ALUMINIUM / STAINLESS STEEL)**



VAW steel galvanised / stainless steel



VAW aluminium

A range of variable guide channel systems, constructed from aluminium or stainless steel sections, are available for this energy chain. The variable guide channel ensures that the energy chain is supported and guided securely.

**ASSEMBLY INSTRUCTION FLEXIBLE CHAIN BRACKET FB/FG**

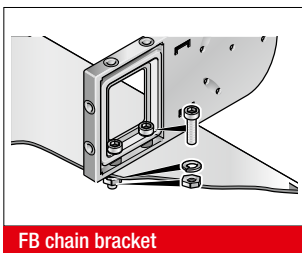

FB chain bracket

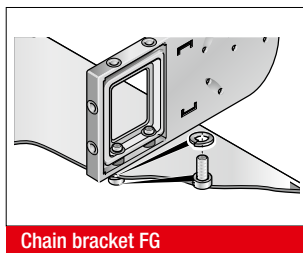

Chain bracket FG

Brass bushes guarantee long-lasting fastening without cold flow in the plastic.

**Version KA-FB:**

Integrated through-hole fastened down using screw and nut.

**Version KA-FG:**

Built-in threads allow for quick and easy on-site mounting, since a screw, including a retaining washer where necessary, is sufficient.

**ASSEMBLY**

**DISASSEMBLY**

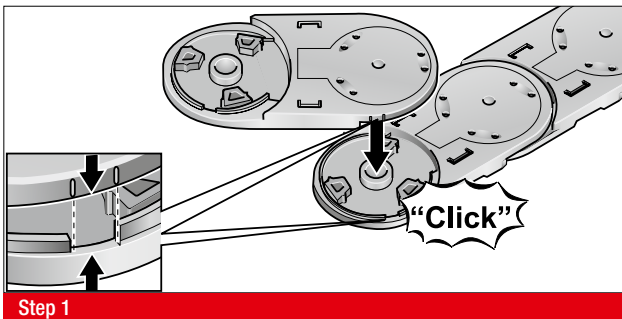

Step 1

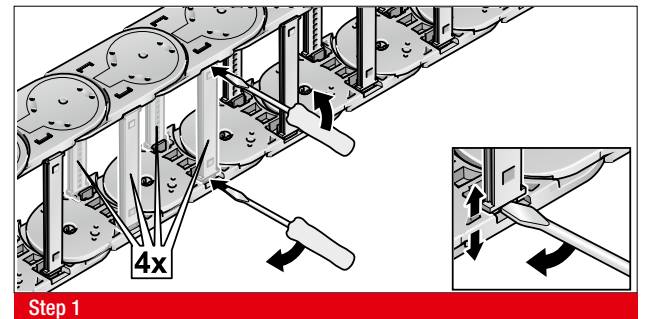

Step 1

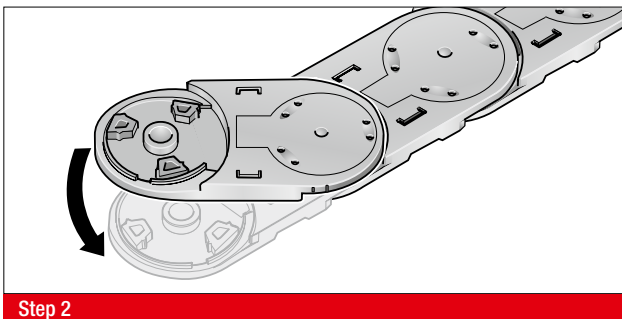

Step 2

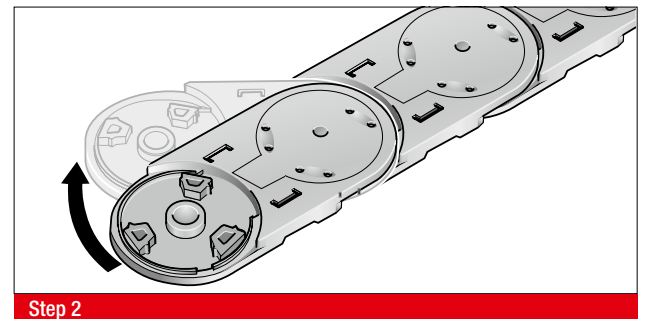

Step 2

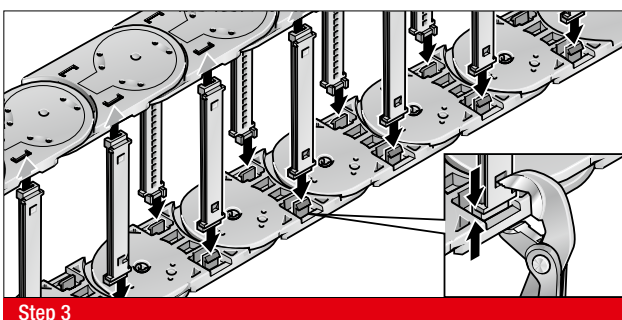

Step 3

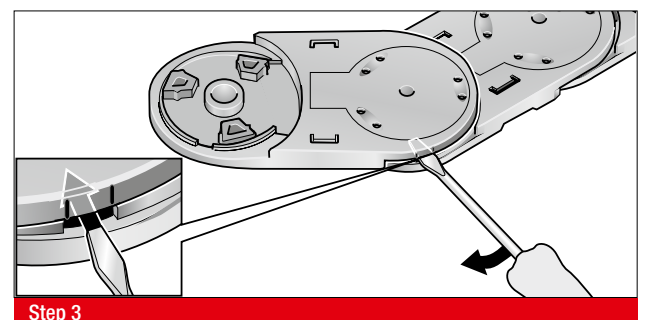

Step 3

## MP 44 OPEN



- PLASTIC OR ALUMINIUM VERSION
- METAL CHAIN BRACKET
- OPENS ON OUTSIDE BEND

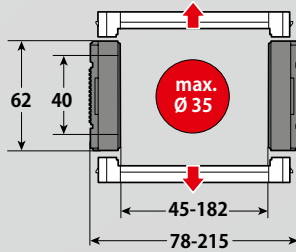

### TECHNICAL DATA

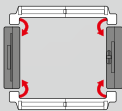

**Loading side**  
Inside and outside bend

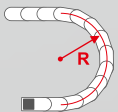

**Available radii**  
90.0 – 400.0 mm

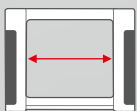

**Available interior widths**  
With plastic crossbar  
45.0 – 182.0 mm  
With alu crossbar / with alu cover  
77.0 – 600.0 mm /

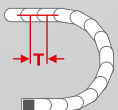

**Pitch**  
T = 75.5 mm



## TECHNICAL SPECIFICATIONS

Travel distance gliding $L_g$ max.	50.0 m
Travel distance self-supporting $L_s$ max.	see diagram on page 369
Travel distance vertical, hanging $L_{vh}$ max.	40.0 m
Travel distance vertical, upright $L_{vs}$ max.	3.0 m
Rotated 90°, unsupported $L_{90f}$ max.	1.0 m
Speed, gliding $V_g$ max.	5.0 m/s
Speed, self-supporting $V_s$ max.	15.0 m/s
Acceleration, gliding $a_g$ max.	15.0 m/s <sup>2</sup>
Acceleration, self-supporting $a_s$ max.	20.0 m/s <sup>2</sup>

Contact our engineering department to meet any higher requirements: [efk@murrplastik.de](mailto:efk@murrplastik.de)



## MATERIAL PROPERTIES

Standard material	Polyamide (PA) black
Service temperature	-30.0 – 120.0 °C
Gliding friction factor	0.3
Static friction factor	0.45
Fire classification	Based on UL 94 HB

Other material properties on request.

### CHAIN BRACKET

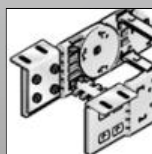

Chain bracket angle

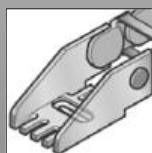

Chain bracket U-part

### SHELVING SYSTEM

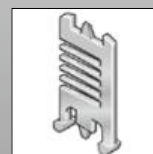

Separator TR



RS shelving system

### GUIDE CHANNELS



VAW aluminium

ORDERING KEY

Type code	Variation	Inside width	Outside width	Inside width	Outside width	Radius	Crossbar variant	Material	Chain length
<b>0440 30</b>	Crossbar on outside bend Crossbar on inside bend Opens on inside and outside bend	<b>045</b> [1.77]	<b>078</b> [3.07]			<b>090</b> [3.54]	<b>0</b> Plastic, full-ridged with bias	<b>0</b> Polyamide standard (PA/black)	
		<b>062</b> [2.44]	<b>095</b> [3.74]						
		<b>084</b> [3.31]	<b>117</b> [4.61]						
		<b>105</b> [4.13]	<b>138</b> [5.43]			<b>125</b> [4.92]	<b>1</b> Plastic, full-ridged without bias	<b>9</b> Special version (on request)	
		<b>144</b> [5.67]	<b>177</b> [6.97]			<b>150</b> [5.91]	<b>2</b> Plastic, half-ridged with bias		
		<b>182</b> [7.17]	<b>215</b> [8.46]			<b>200</b> [7.87]	<b>3</b> Plastic, half-ridged without bias		
						<b>250</b> [9.84]	<b>4</b> Aluminium full-ridged with bias		
						<b>300</b> [11.81]	<b>5</b> Aluminium full-ridged without bias		
						<b>400</b> [15.75]	<b>6</b> Aluminium half-ridged with bias		
							<b>7</b> Aluminium half-ridged without bias		
							<b>9</b> Special version (on request)		

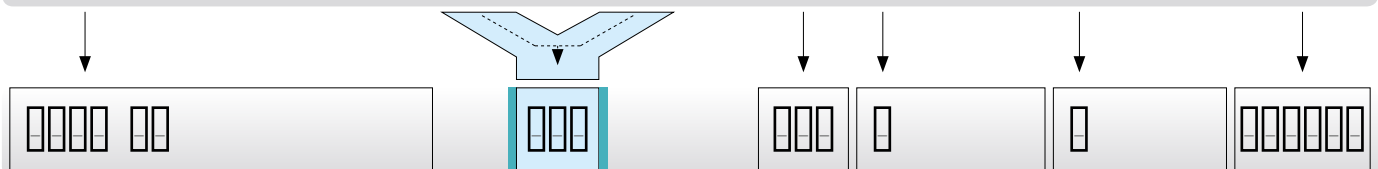

ORDERING EXAMPLE: 0440 30 045 090 0 0 1359

Crossbar on outside bend, crossbar on inside bend, can be opened from inside and outside bend  
 Inside width 45 mm; radius 90 mm  
 Plastic crossbar, full-ridged with bias, material black-coloured polyamide  
 Chain length 1359 mm (18 links)

**NOTE ON CONFIGURATION**

**Aluminium crossbars:**

Aluminium crossbars can be supplied in 1 mm width sizes for inner widths from 77.0 mm – 600.0 mm .

**Strain relief:**

The end brackets utilise strain relief plates (ZL) for cable strain relief.

For detailed information, please consult the corresponding product documentation.

**SELF-SUPPORTING LENGTH**

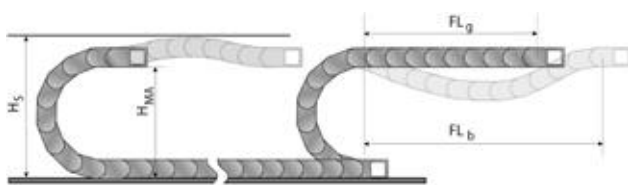

The self-supporting length is the distance between the chain bracket on the moving end and the start of the chain arch. The installation variant  $FL_g$  offers the lowest load and wear for the energy chain.

The maximum travel parameters (speed and acceleration) can be applied for this variant.

- $H_s$  = Installation height plus safety
- $H_{MA}$  = Height of moving end connection
- $FL_g$  = Self-supporting length, upper run straight
- $FL_b$  = Self-supporting length, upper run bent

**LOAD DIAGRAM FOR SELF-SUPPORTING APPLICATIONS**

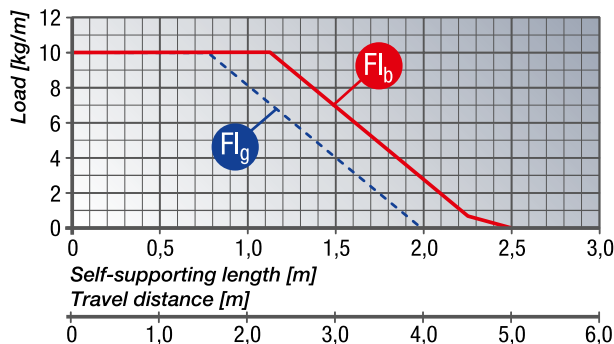

**$FL_g$  Self-supporting length, upper run straight**

In the  $FL_g$  range, the chain upper run still has a bias, is straight or has a maximum sag of 60.0 mm.

**$FL_b$  Self-supporting length, upper run bent**

In the  $FL_b$  range, the chain upper run has a sag of more than 60.0 mm, but this is still less than the maximum sag. Where the sag is greater than that permitted in the  $FL_b$  range, the application is critical and should be avoided. The self-supporting length can be optimised by using a support for the upper run or a more stable energy chain.

**DETERMINING THE CHAIN LENGTH**

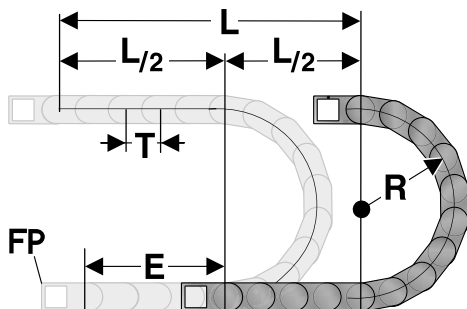

The fixed point of the energy chain should be connected in the middle of the travel distance.

This arrangement gives the shortest connection between the fixed point (FP) and the moving consumer and thus the most efficient chain length.

Chain length calculation =  $L/2 + \pi * R + E$   
 $\approx 1 \text{ m chain} = 13 \text{ qty. } \times 75.5 \text{ mm.}$

- E = Distance between entry point and middle of travel distance
- L = Travel distance
- R = Radius
- P = Pitch 75.5 mm

**INSTALLATION DIMENSIONS**

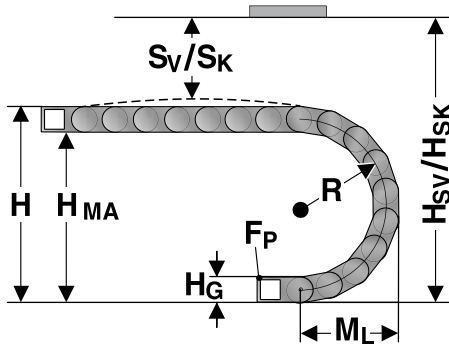

The moving end chain connection is to be screw fixed at height  $H_{MA}$  for the respective radius. Concerning the installed dimensions, you must take into account whether the chain links are equipped with or without bias. For chain links without bias, the “Installed height without bias  $H_{SK}$ ” value has to be taken into account. If the chain links are equipped with a bias, the value “Installed height with bias  $H_{SV}$ ” has to be taken into account.

Radius R	90	125	150	200	250	300	400
Outside height of chain link ( $H_G$ )	62	62	62	62	62	62	62
Height of bend (H)	242	312	362	462	562	662	862
Height of moving end bracket ( $H_{MA}$ )	180	250	300	400	500	600	800
Safety margin with bias ( $S_v$ )	38	38	38	38	38	38	38
Installation height with bias ( $H_{sv}$ )	280	350	400	500	600	700	900
Safety margin without bias ( $S_k$ )	13	13	13	13	13	13	13
Installation height without bias ( $H_{sk}$ )	255	325	375	475	575	675	875
Arc projection ( $M_L$ )	197	232	257	307	357	407	507

**KA 44 CHAIN BRACKET ANGLE**

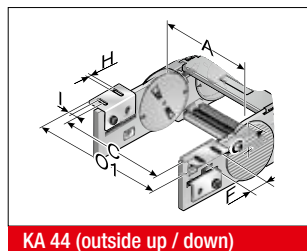
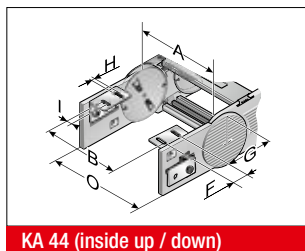

There are several options regarding the chain bracket. The fixed-point bracket (inside/bottom) and the moving end bracket (inside/top) are supplied as standard. However, any other combination can be supplied upon request. The chain bracket is fastened at the end like a side link. This enables the chain to move right up to the bracket. Each chain requires two chain brackets. The brackets should be fastened with M6 screws.

Type	Order No.	Material	Inside width								Outside width of KA 0 mm	Outside width of KA 01 mm	
			A mm	B mm	C mm	E mm	F mm	G mm	G1 mm	H0 mm			I mm
KA 44	0440000050	Sheet steel	62.0 – 182.0	A-14.5	A+38.5	A+32.0	32.0	43.2	86.0	6.5	12.5	A+33.0	A+64.0
KA 44	0440000052	Stainless steel 1.4301	62.0 – 182.0	A-14.5	A+38.5	A+32.0	32.0	43.2	86.0	6.5	12.5	A+33.0	A+64.0

**KA 44 CHAIN BRACKET U-PART**

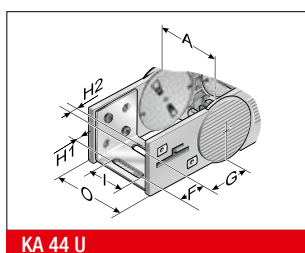

The chain bracket is an all-plastic part. The bracket is precisely adjusted to the respective chain width and only needs to be snapped in at the chain link. Please order one male and one female end bracket for each chain. The brackets should be fastened with M5 screws. The cables or conduits may be fastened with cable ties on the integrated strain relief of the chain bracket.

Type	Order No.	Material	Inside width						Outside width of KA 0 mm
			A mm	F mm	G mm	H1 mm	H2 mm	I mm	
KA 44 U	0440000054	Stainless steel 1.4301	45.0	28.0	45.0	6.5	8.5	33.0	A+33.0

**TR 44 SEPARATOR**

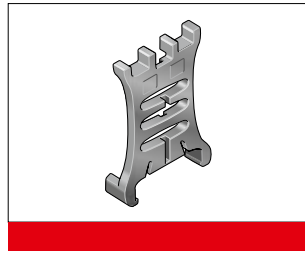
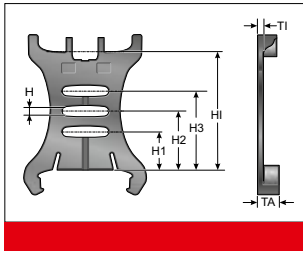

We recommend that separators be used if multiple round cables or conduits with differing diameters are to be installed. For applications with aluminium frame bridges or when movable separators are to be used, the TL 44 separator should be used.

Type	Order No.	Description	T1 mm	TA mm	H mm	H1 mm	H2 mm	H3 mm	H4 mm
TF 44	044000009400	Separator	4.0	8.5	4.3	13.3	20.5	27.7	41.0
TL 44	044000009200	Separator for aluminium frame bridges	4.0	8.5	4.3	13.3	20.5	27.7	41.0

**MP 44 SHELVING SYSTEM**

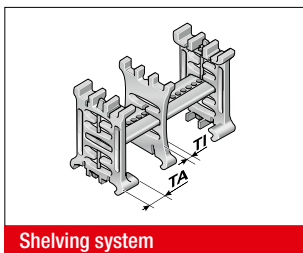

Shelving system

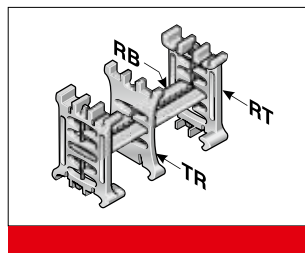

The shelf must be used with a minimum of two separators to create a shelving system. The additional levels prevent cables from criss-crossing and minimise the friction between them. The shelving system may be preassembled on request.

Type	Order No.	Description	Width mm	Clearance width mm	Pitch mm	T1 mm	H1 mm	H2 mm	H3 mm	H4 mm	H5 mm
RB 031	100000003100	Shelf	42.0	31.0	1.6						
RB 048	100000004800	Shelf	59.0	48.0	1.6						
RB 070	100000007000	Shelf	81.0	70.0	1.6						
RB 092	100000009200	Shelf	103.0	92.0	1.6						
RB 100	100000010000	Shelf	111.0	100.0	1.6						
RB 128	100000012800	Shelf	139.0	128.0	1.6						
RB 167	100000016700	Shelf	178.0	167.0	1.6						
RT 44	1000902100	Shelf support	4.3		1.6	6.5	6.4	13.3	20.5	27.7	34.8

**GUIDE CHANNEL VAW (ALUMINIUM)**



VAW aluminium

A variable guide channel system, constructed from aluminium sections, is available for this energy chain. The variable guide channel ensures that the energy chain is supported and guided securely.

ASSEMBLY

DISASSEMBLY

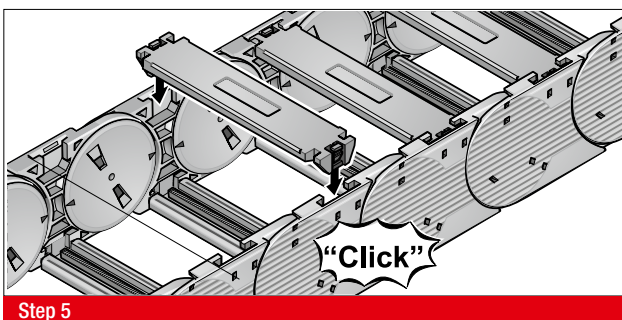
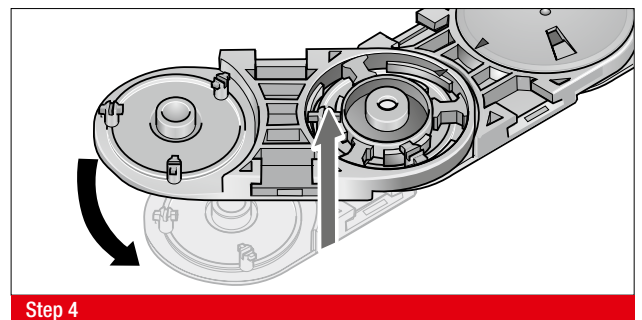
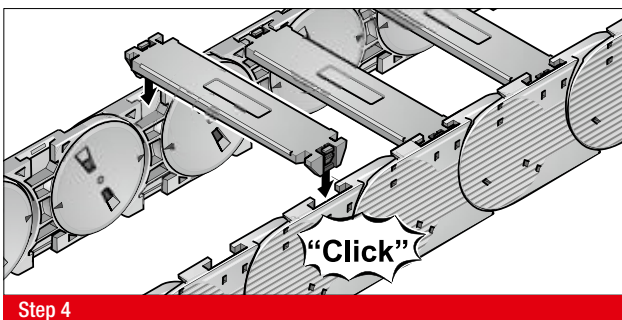
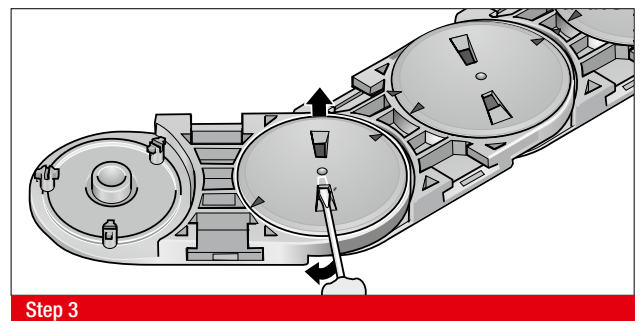
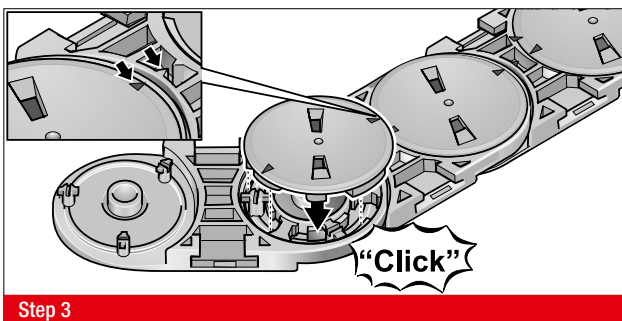
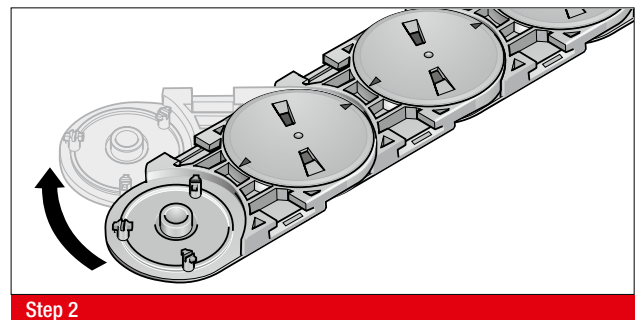
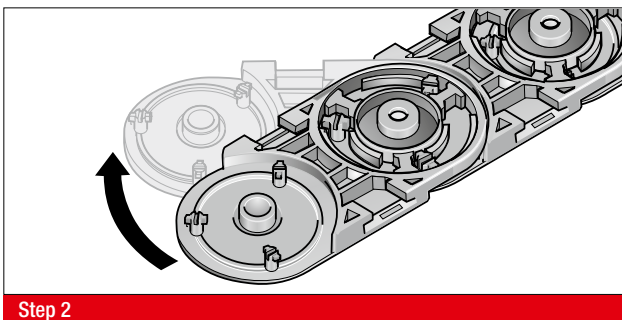
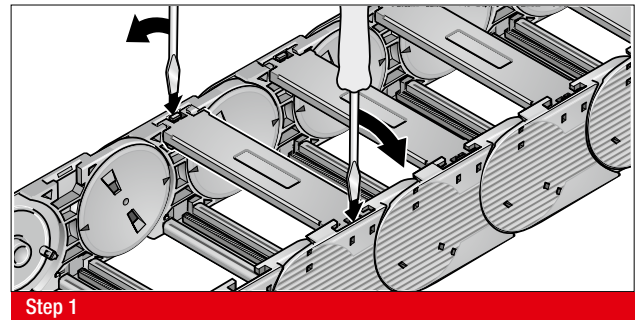
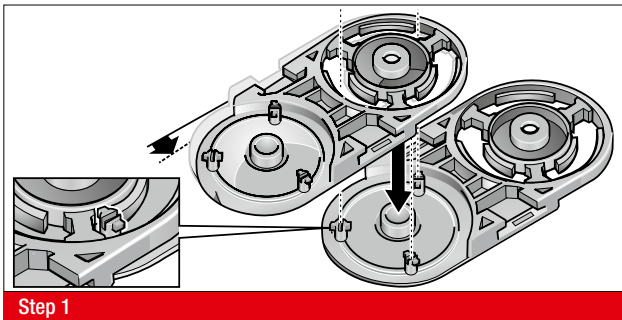





## MP 52.1 OPEN



- PLASTIC OR ALUMINIUM VERSION
- CHAIN BRACKET FLEXIBLE

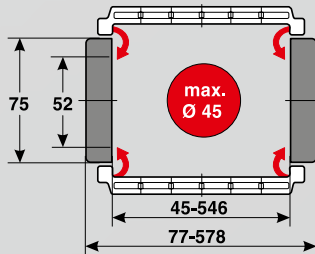

### TECHNICAL DATA

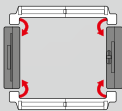

**Loading side**  
Inside and outside bend

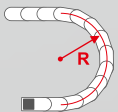

**Available radii**  
100.0 – 350.0 mm

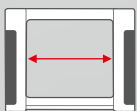

**Available interior widths**  
With plastic crossbar  
45.0 – 546.0 mm  
With alu crossbar / with alu cover  
67.0 – 600.0 mm /

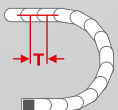

**Pitch**  
T = 91.0 mm

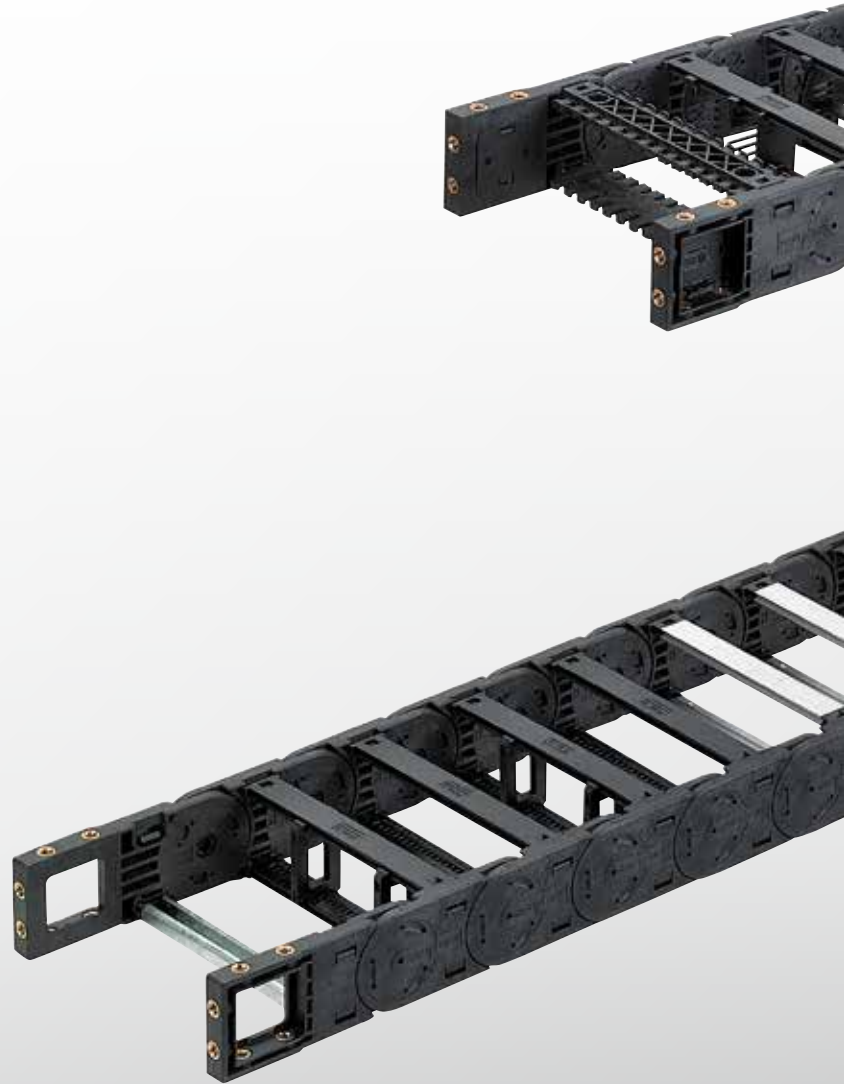



## TECHNICAL SPECIFICATIONS

Travel distance gliding $L_g$ max.	150.0 m
Travel distance self-supporting $L_s$ max.	see diagram on page 377
Travel distance vertical, hanging $L_{vh}$ max.	60.0 m
Travel distance vertical, upright $L_{vs}$ max.	6.0 m
Rotated 90°, unsupported $L_{90f}$ max.	3.0 m
Speed, gliding $V_g$ max.	5.0 m/s
Speed, self-supporting $V_f$ max.	20.0 m/s
Acceleration, gliding $a_g$ max.	25.0 m/s <sup>2</sup>
Acceleration, self-supporting $a_s$ max.	30.0 m/s <sup>2</sup>

Contact our engineering department to meet any higher requirements: [efk@murrplastik.de](mailto:efk@murrplastik.de)

## MATERIAL PROPERTIES

Standard material	Polyamide (PA) black
Service temperature	-30.0 – 120.0 °C
Gliding friction factor	0.3
Static friction factor	0.45
Fire classification	UL 94 HB

Other material properties on request.

### SHELVING SYSTEM



Separator TR

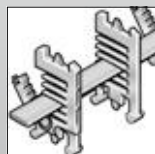

RS shelving system

### CHAIN BRACKET

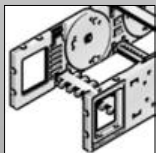

Chain bracket flexible

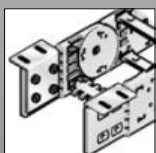

Chain bracket angle



Crossbar connector RSV



H-shaped shelf unit RE

### ACCESSORIES



Bracket bar

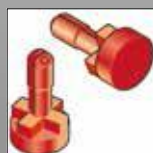

Lock button

### GUIDE CHANNELS



VAW steel galvanised / stainless steel

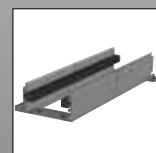

VAW aluminium

### STRAIN RELIEF

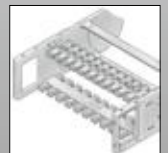

RS-ZL crossbar strain relief

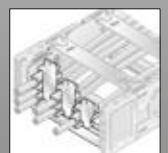

STF Steel Fix

**ORDERING KEY**

Type code	Variation	Inside width	Outside width	Inside width	Outside width	Radius	Crossbar variant	Material	Chain length
<b>0521 30</b>	Crossbar on outside bend Crossbar on inside bend Opens on inside and outside bend	<b>045</b> [1.77]	<b>077</b> [3.03]	<b>233</b> [9.17]	<b>265</b> [10.43]	<b>100</b> [3.94]	<b>0</b> Plastic, full-ridged with bias	<b>0</b> Polyamide standard (PA/black)	
		<b>057</b> [2.24]	<b>089</b> [3.50]	<b>246</b> [9.69]	<b>278</b> [10.94]				
		<b>062</b> [2.44]	<b>094</b> [3.70]	<b>252</b> [9.92]	<b>284</b> [11.18]	<b>150</b> [5.91]	<b>1</b> Plastic, full-ridged without bias	<b>9</b> Special version (on request)	
		<b>071</b> [2.80]	<b>103</b> [4.06]	<b>258</b> [10.16]	<b>290</b> [11.42]				
		<b>084</b> [3.31]	<b>116</b> [4.57]	<b>296</b> [11.65]	<b>328</b> [12.91]	<b>200</b> [7.87]	<b>2</b> Plastic, half-ridged with bias		
		<b>093</b> [3.66]	<b>125</b> [4.92]	<b>346</b> [13.62]	<b>378</b> [14.88]				
		<b>096</b> [3.78]	<b>128</b> [5.04]	<b>350</b> [13.78]	<b>382</b> [15.04]	<b>250</b> [9.84]	<b>3</b> Plastic, half-ridged without bias		
		<b>104</b> [4.09]	<b>136</b> [5.35]	<b>358</b> [14.09]	<b>390</b> [15.35]				
		<b>107</b> [4.21]	<b>139</b> [5.47]	<b>371</b> [14.61]	<b>403</b> [15.87]	<b>300</b> [11.81]	<b>4</b> Aluminium full-ridged with bias		
		<b>121</b> [4.76]	<b>153</b> [6.02]	<b>396</b> [15.59]	<b>428</b> [16.85]				
		<b>133</b> [5.24]	<b>165</b> [6.50]	<b>421</b> [16.57]	<b>453</b> [17.83]	<b>350</b> [13.78]	<b>5</b> Aluminium full-ridged without bias		
		<b>144</b> [5.67]	<b>176</b> [6.93]	<b>446</b> [17.56]	<b>478</b> [18.82]				
		<b>146</b> [5.75]	<b>178</b> [7.01]	<b>496</b> [19.53]	<b>528</b> [20.79]		<b>6</b> Aluminium half-ridged with bias		
		<b>158</b> [6.22]	<b>190</b> [7.48]	<b>546</b> [21.50]	<b>578</b> [22.76]				
		<b>164</b> [6.46]	<b>196</b> [7.72]				<b>7</b> Aluminium half-ridged without bias		
		<b>171</b> [6.73]	<b>203</b> [7.99]						
		<b>182</b> [7.17]	<b>214</b> [8.43]				<b>9</b> Special version (on request)		
		<b>196</b> [7.72]	<b>228</b> [8.98]						
		<b>208</b> [8.19]	<b>240</b> [9.45]						
		<b>220</b> [8.66]	<b>252</b> [9.92]						

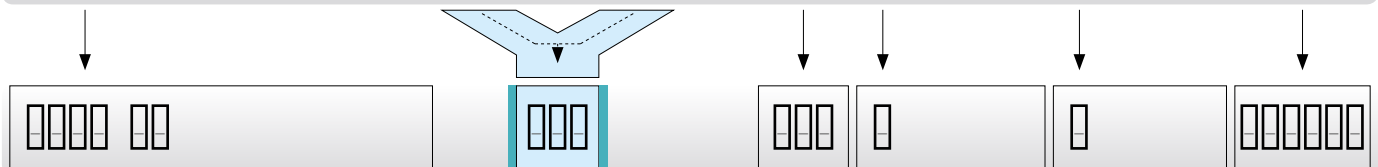

**ORDERING EXAMPLE: 0521 30 045 100 0 0 1365**

Crossbar on outside bend, crossbar on inside bend, can be opened from inside and outside bend  
 Inside width 45 mm; radius 100 mm  
 Plastic crossbar, full-ridged with bias, material black-coloured polyamide  
 Chain length 1365 mm (15 links)

**NOTE ON CONFIGURATION**

**Aluminium crossbars:**

Aluminium crossbars can be supplied in 1 mm width sizes for inner widths from 67.0 mm – 600.0 mm .

**Crossbar connector and crossbar strain relief plate:**

Once inside widths exceed 246 mm, we recommend the deployment of crossbar connectors (RSV).  
If crossbar strain relief plates (RS-ZL) are to be deployed in the chain brackets, take standard inside widths into account.

For detailed information, please consult the corresponding product documentation.

**SELF-SUPPORTING LENGTH**

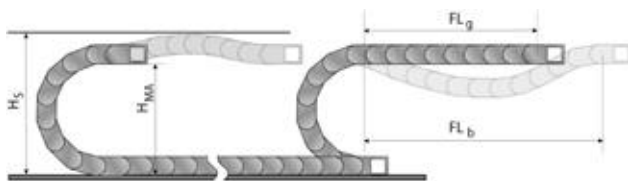

The self-supporting length is the distance between the chain bracket on the moving end and the start of the chain arch.  
The installation variant  $FL_g$  offers the lowest load and wear for the energy chain.  
The maximum travel parameters (speed and acceleration) can be applied for this variant.

- $H_s$  = Installation height plus safety
- $H_{MA}$  = Height of moving end connection
- $FL_g$  = Self-supporting length, upper run straight
- $FL_b$  = Self-supporting length, upper run bent

**LOAD DIAGRAM FOR SELF-SUPPORTING APPLICATIONS**

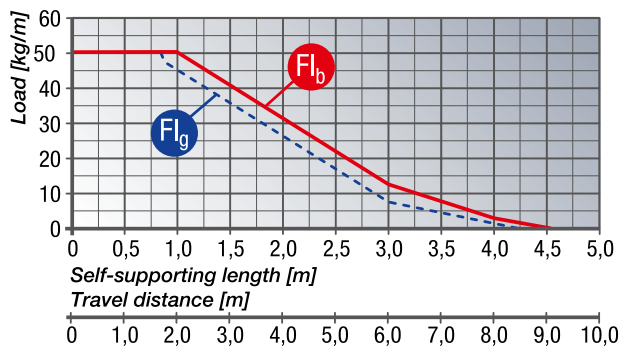

**$FL_g$  Self-supporting length, upper run straight**

In the  $FL_g$  range, the chain upper run still has a bias, is straight or has a maximum sag of 70.0 mm.

**$FL_b$  Self-supporting length, upper run bent**

In the  $FL_b$  range, the chain upper run has a sag of more than 70.0 mm, but this is still less than the maximum sag.  
Where the sag is greater than that permitted in the  $FL_b$  range, the application is critical and should be avoided. The self-supporting length can be optimised by using a support for the upper run or a more stable energy chain.

**DETERMINING THE CHAIN LENGTH**

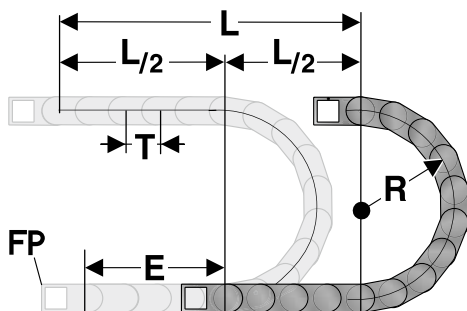

The fixed point of the energy chain should be connected in the middle of the travel distance.  
This arrangement gives the shortest connection between the fixed point (FP) and the moving consumer and thus the most efficient chain length.

Chain length calculation =  $L/2 + \pi * R + E$   
 $\approx 1 \text{ m chain} = 11 \text{ qty. } \times 91.0 \text{ mm.}$

- E = Distance between entry point and middle of travel distance
- L = Travel distance
- R = Radius
- P = Pitch 91.0 mm

**INSTALLATION DIMENSIONS**

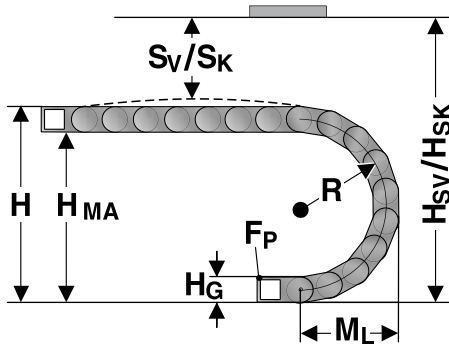

The moving end chain connection is to be screw fixed at height  $H_{MA}$  for the respective radius.

Concerning the installed dimensions, you must take into account whether the chain links are equipped with or without bias.

For chain links without bias, the "Installed height without bias  $H_{SK}$ " value has to be taken into account.

If the chain links are equipped with a bias, the value "Installed height with bias  $H_{SV}$ " has to be taken into account.

Radius R	100	150	200	250	300	350
Outside height of chain link ( $H_c$ )	75	75	75	75	75	75
Height of bend (H)	305	405	505	605	705	805
Height of moving end bracket ( $H_{MA}$ )	230	330	430	530	630	730
Safety margin with bias ( $S_v$ )	46	46	46	46	46	46
Installation height with bias ( $H_{sv}$ )	351	451	551	651	751	851
Safety margin without bias ( $S_k$ )	16	16	16	16	16	16
Installation height without bias ( $H_{sk}$ )	321	421	521	621	721	821
Arc projection ( $M_l$ )	244	294	344	394	444	494

**POWERLINE PLASTIC CROSSBAR**

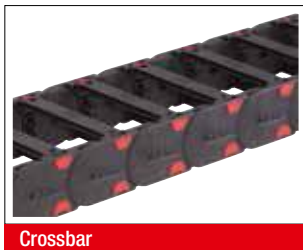

Crossbar

The crossbars connect the two side runs of the energy chain. The crossbar length is synonymous with the inside width of the energy chain.

Type	Order No.	Description	Inside width mm
RS 045-5	052004500000	Crossbar	45.0
RS 057-5	052005700000	Crossbar	57.0
RS 062-5	052006200000	Crossbar	62.0
RS 071-5	052007100000	Crossbar	71.0
RS 084-5	052008400000	Crossbar	84.0
RS 093-5	052009300000	Crossbar	93.0
RS 096-5	052009600000	Crossbar	96.0
RS 104-5	052010400000	Crossbar	104.0
RS 107-5	052010700000	Crossbar	107.0
RS 121-5	052012100000	Crossbar	121.0
RS 133-5	052013300000	Crossbar	133.0
RS 144-5	052014400000	Crossbar	144.0
RS 146-5	052014600000	Crossbar	146.0
RS 158-5	052015800000	Crossbar	158.0
RS 164-5	052016400000	Crossbar	164.0

**POWERLINE PLASTIC CROSSBAR**

Type	Order No.	Description	Inside width mm
RS 171-5	052017100000	Crossbar	171.0
RS 182-5	052018200000	Crossbar	182.0
RS 196-5	052019600000	Crossbar	196.0
RS 208-5	052020800000	Crossbar	208.0
RS 220-5	052022000000	Crossbar	220.0
RS 233-5	052023300000	Crossbar	233.0
RS 246-5	052024600000	Crossbar	246.0
RS 252-5	052025200010	Crossbar	252.0
RS 258-5	052025800000	Crossbar	258.0
RS 296-5	052029600000	Crossbar	296.0
RS 346-5	052034600000	Crossbar	346.0
RS 350-5	052035000000	Crossbar	350.0
RS 358-5	052035800000	Crossbar	358.0
RS 371-5	052037100000	Crossbar	371.0
RS 396-5	052039600000	Crossbar	396.0
RS 421-5	052042100000	Crossbar	421.0
RS 446-5	052044600000	Crossbar	446.0
RS 496-5	052049600000	Crossbar	496.0
RS 546-5	052054600000	Crossbar	546.0

**KA 52.1 CHAIN BRACKET FLEXIBLE**

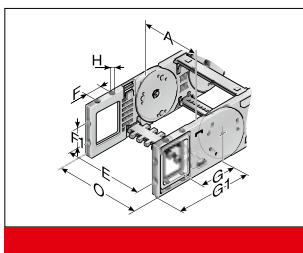

This chain bracket offers universal connection options (top, bottom and front) and is attached to the ends of the chain like a side link. This allows the chain to move right up to the bracket. Each chain requires one male and one female bracket. M8 screws are used to secure the brackets in place. Extrusion-coated metal bushes with either a through-hole (-FB) or a threaded hole (-FG) ensure the permanent, high-strength transmission of even extreme forces onto the energy chain.

Type	Order No.	Material	Version	Inside width								Outside width of KA 0 mm
				A mm	E mm	F mm	F1 mm	G mm	G1 mm	H mm	H0 mm	
KA 52.1-FB Female end	0521000056	Plastic	with bush	45.0 – 546.0	A+16.0	35.0	30.0	89.0	146.0	8.5	A+36.0	
KA 52.1-FB Male end	0521000057	Plastic	with bush	45.0 – 546.0	A+16.0	35.0	30.0	89.0	146.0	8.5	A+36.0	
KA 52.1-FG Female end	0521000058	Plastic	with thread	45.0 – 546.0	A+16.0	35.0	30.0	89.0	146.0	M8	A+36.0	
KA 52.1-FG Male end	0521000059	Plastic	with thread	45.0 – 546.0	A+16.0	35.0	30.0	89.0	146.0	M8	A+36.0	

**KA 52.1 CHAIN BRACKET ANGLE**

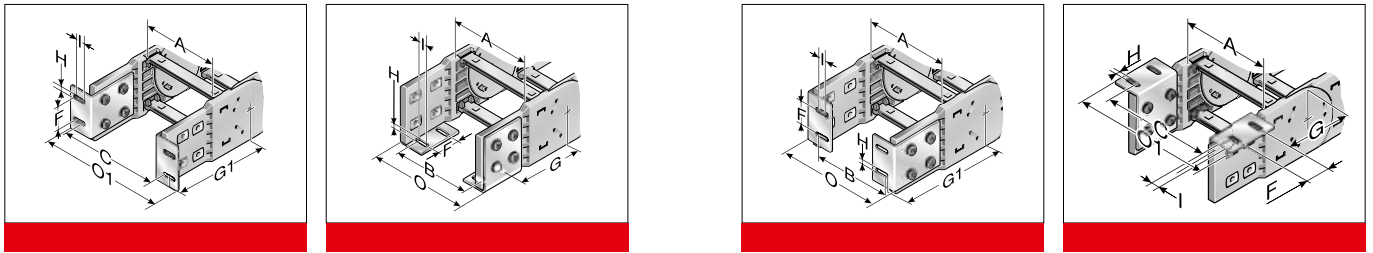

There are several options regarding the chain bracket. The fixed-point bracket (inside/bottom) and the moving end bracket (inside/top) are supplied as standard. However, any other combination can be supplied upon request. The chain bracket is

fastened at the end like a side link. This enables the chain to move right up to the bracket. Each chain requires one male and one female bracket. The brackets should be fastened with M6 screws.

Type	Order No.	Material	Inside width								Outside width	
			A mm	B mm	C mm	F mm	G mm	G1 mm	HØ mm	I mm	of KA 0 mm	of KA 01 mm
KA 52.1 Female end	0521000050	Sheet steel	45.0 – 546.0	A-2.5	A+34.5	32.0	95.5	144.0	6.5	14.0	A+32.0	A+71.0
KA 52.1 Male end	0521000051	Sheet steel	45.0 – 546.0	A-2.5	A+34.5	32.0	95.5	144.0	6.5	14.0	A+32.0	A+71.0

**TR 52 SEPARATOR**

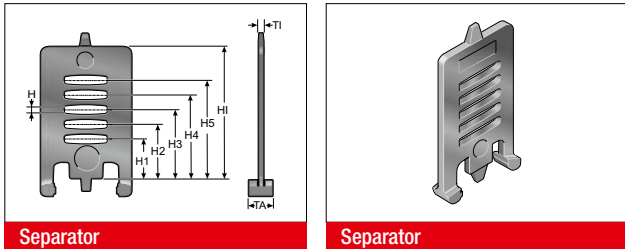

We recommend that separators be used if multiple round cables or conduits with differing diameters are to be installed. The closed separator is used when no shelves are used. This is the recommended design for travel paths of 30 metres or greater.

Type	Order No.	Description	Version	TI mm	TA mm	H mm	H1 mm	H2 mm	H3 mm	H4 mm	H5 mm	H1 mm
TR 52	052000009200	TR 52 Separator	lockable	3.5	10.0	4.2	16.3	22.3	28.2	33.8	39.8	52.0

**TR 52.1 SEPARATOR**

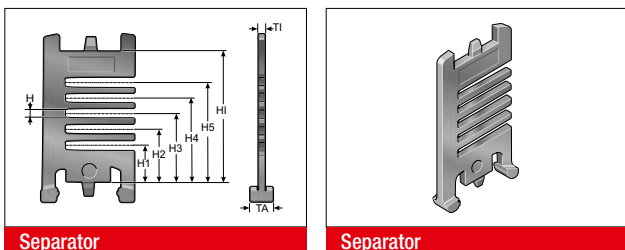

We recommend that separators be used if multiple round cables or conduits with differing diameters are to be installed.

Type	Order No.	Description	Version	TI mm	TA mm	H mm	H1 mm	H2 mm	H3 mm	H4 mm	H5 mm	H1 mm
TR 52.1	052100009200	TR 52.1 Separator	lockable	3.5	8.0	4.0	15.6	22.0	28.2	34.6	41.0	52.0



**TR 52-V SEPARATOR**

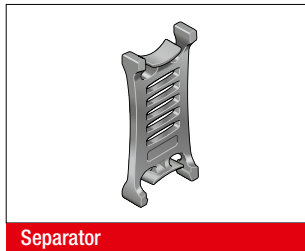
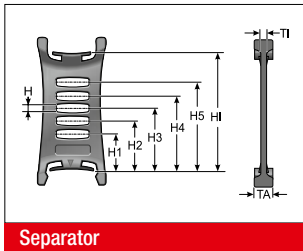

We recommend that separators be used if multiple round cables or conduits with differing diameters are to be installed.

Type	Order No.	Description	Version	TI mm	TA mm	H mm	H1 mm	H2 mm	H3 mm	H4 mm	H5 mm	H1 mm
TR 52-V	052000009300	TR 52-V Separator	moveable	3.5	13.0	4.0	16.3	22.3	28.2	33.8	39.8	52.0

**RTT 52 SHELF SUPPORT, DIVISIBLE**

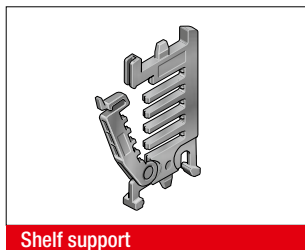
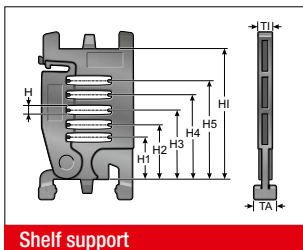

In connection with two separable shelf supports (RTT) with at least one end-to-end shelf (RB) the shelf becomes an easy to fill shelving system. The additional levels prevent cables from criss-crossing and minimise the friction between them.

Type	Order No.	Description	Version	TI mm	TA mm	H mm	H1 mm	H2 mm	H3 mm	H4 mm	H5 mm	H1 mm
RTT 52	100090522000	Shelf support, divisible	lockable	7.0	8.0	4.0	15.6	22.0	28.2	34.6	41.0	52.0

**RB-5 SHELF**

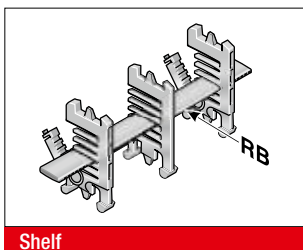

In connection with at least two separable shelf supports (RTT), the shelf becomes a shelving system. The additional levels prevent cables from criss-crossing and minimise the friction between them.

Type	Order No.	Description	Width mm	Inside width mm
RB 028-5	100000002800	Shelf	28.0	45.0
RB 034-5	1000003405	Shelf	33.6	45.0
RB 039-5	1000003905	Shelf	39.2	45.0
RB 045-5	1000004505	Shelf	44.8	57.0
RB 050-5	1000005005	Shelf	50.4	57.0
RB 056-5	10000005601	Shelf	56.0	62.0
RB 062-5	1000006205	Shelf	61.6	62.0
RB 067-5	1000006705	Shelf	67.2	84.0
RB 073-5	1000007305	Shelf	72.8	84.0
RB 078-5	1000007805	Shelf	78.4	84.0
RB 084-5	10000008400	Shelf	84.0	84.0
RB 090-5	1000009005	Shelf	89.6	96.0
RB 095-5	1000009505	Shelf	95.2	96.0
RB 101-5	1000010105	Shelf	100.8	107.0
RB 106-5	1000010605	Shelf	106.4	107.0

## RB-5 SHELF

Type	Order No.	Description	Width mm	Inside width mm
RB 112-5	100000011200	Shelf	112.0	121.0
RB 118-5	1000011805	Shelf	117.6	121.0
RB 123-5	1000012305	Shelf	123.2	133.0
RB 129-5	1000012905	Shelf	128.8	133.0
RB 134-5	1000013405	Shelf	134.4	144.0
RB 140-5	100000014000	Shelf	140.0	144.0
RB 146-5	1000014605	Shelf	145.6	158.0
RB 151-5	1000015105	Shelf	151.2	158.0
RB 157-5	1000015705	Shelf	156.8	164.0
RB 162-5	1000016205	Shelf	162.4	164.0
RB 168-5	100000016800	Shelf	168.0	182.0
RB 174-5	1000017405	Shelf	173.6	182.0
RB 179-5	1000017905	Shelf	179.2	196.0
RB 185-5	1000018505	Shelf	184.8	196.0
RB 190-5	1000019005	Shelf	190.4	196.0
RB 196-5	100000019600	Shelf	196.0	196.0
RB 291-5	100000029100	Shelf	291.2	346.0

## RSV 52 CROSSBAR CONNECTOR



Crossbar connector

For crossbars wider than 246 mm, we recommend the use of crossbar connectors. These prevent deformation to the crossbar under large amounts of additional weight of the chain assembly.

Type	Order No.	Description	Tl mm
RSV 52	052000009600	Crossbar connector	7.5
RSV 52 Alu	052000009800	Crossbar connector for aluminium crossbars	7.5

## RE 52 H-SHAPED SHELF UNIT

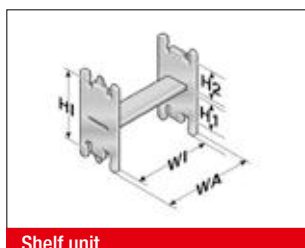

Shelf unit

One-piece shelving system, the shelf cannot be varied in height.

Type	Order No.	Description	WA mm	W1 mm	H1 mm	H2 mm	H3 mm
RE 36/17	100000361714	H-shaped shelf unit	42.5	36.5	31.0	17.4	52.0
RE 59/24	100000592414	H-shaped shelf unit	65.0	59.0	24.2	24.2	52.0
RE 81/12	100000811214	H-shaped shelf unit	87.5	81.5	36.0	12.4	52.0

## BS-5 BRACKET BAR



Large-diameter conduits are routed securely by using a bracket bar (BS). This bar is installed on the crossbars or the covers of the energy chain.

The bracket bar can be installed on both the inside and outside bend.

The bracket bar support (BSH) is used to attach the bars to PowerLine series crossbars. Two bracket bar supports are required for each bar.

Type	Order No.	Description	Conduit diameter max. mm	Installation height mm	Inner chain width min. mm
BS 120-5	052412000000	Bracket bar	115.0	140.0	164.0
BS 153-5	052415300000	Bracket bar	148.0	170.0	208.0
BS 187-5	052418700000	Bracket bar	182.0	205.0	233.0
BSH-5	052400000000	Bracket bar support			
Assembly set	052400000001	Assembly set			

## RS-ZL-5 CROSSBAR STRAIN RELIEF PLATE

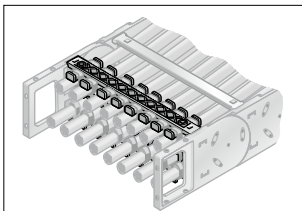

Crossbar strain relief plate

Fixed integrated frame bridge strain relief plates in the chain brackets. Tailored to all crossbar widths up to 246 mm. May be assembled on the inside and outside bends at both chain endings.

Type	Order No.	Description	Inside width mm
RS-ZL 045-5	052004500010	Crossbar strain relief plate	45.0
RS-ZL 057-5	052005700010	Crossbar strain relief plate	57.0
RS-ZL 062-5	052006200010	Crossbar strain relief plate	62.0
RS-ZL 071-5	052007100010	Crossbar strain relief plate	71.0
RS-ZL 084-5	052008400010	Crossbar strain relief plate	84.0
RS-ZL 093-5	052009300010	Crossbar strain relief plate	93.0
RS-ZL 096-5	052009600010	Crossbar strain relief plate	96.0
RS-ZL 104-5	052010400010	Crossbar strain relief plate	104.0
RS-ZL 107-5	052010700010	Crossbar strain relief plate	107.0
RS-ZL 121-5	052012100010	Crossbar strain relief plate	121.0
RS-ZL 133-5	052013300010	Crossbar strain relief plate	133.0
RS-ZL 144-5	052014400010	Crossbar strain relief plate	144.0
RS-ZL 146-5	052014600010	Crossbar strain relief plate	146.0
RS-ZL 158-5	052015800010	Crossbar strain relief plate	158.0
RS-ZL 164-5	052016400010	Crossbar strain relief plate	164.0
RS-ZL 171-5	052017100010	Crossbar strain relief plate	171.0
RS-ZL 182-5	052018200010	Crossbar strain relief plate	182.0
RS-ZL 196-5	052019600010	Crossbar strain relief plate	196.0
RS-ZL 208-5	052020800010	Crossbar strain relief plate	208.0
RS-ZL 220-5	052022000010	Crossbar strain relief plate	220.0
RS-ZL 233-5	052023300010	Crossbar strain relief plate	233.0
RS-ZL 246-5	052024600010	Crossbar strain relief plate	246.0

## STRAIN RELIEF WITH STEEL FIX

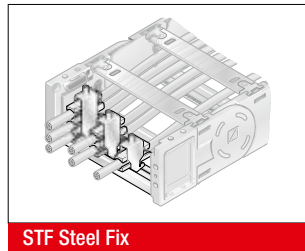
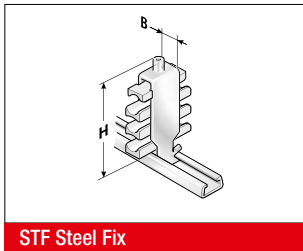

C-rails (galvanised) for permanent integration, for accommodating the Steel Fix bow clamps in the chain brackets. The bow clamps can take up to 3 cables and are suitable for C-rails with a groove width of 11 mm. Due to the design of the trough elements, a cable preserving cable guidance is ensured. May be assembled on the inside and outside bends at both chain endings. The overall height stated is a guide only. The actual height is, amongst other things, dependent on the diameter and the quality of the cable. A safety distance of 10 mm at the fixed point above the strain relief must be kept during gliding applications.

Type	Order No.	Description	Seats qty.	Cable Ø mm	Width mm	Total height (H) mm
<b>Single clamp (for one cable)</b>						
STF 12-1 Steel Fix	81661801	Hooped clamp	1	6.0 – 12.0	16.0	55.0
STF 14-1 Steel Fix	81661802	Hooped clamp	1	12.0 – 14.0	18.0	52.0
STF 16-1 Steel Fix	81661803	Hooped clamp	1	14.0 – 16.0	20.0	54.0
STF 18-1 Steel Fix	81661804	Hooped clamp	1	16.0 – 18.0	22.0	56.0
STF 20-1 Steel Fix	81661805	Hooped clamp	1	18.0 – 20.0	24.0	59.0
STF 22-1 Steel Fix	81661806	Hooped clamp	1	20.0 – 22.0	26.0	61.0
STF 26-1 Steel Fix	81661807	Hooped clamp	1	22.0 – 26.0	30.0	70.0
STF 30-1 Steel Fix	81661808	Hooped clamp	1	26.0 – 30.0	34.0	74.0
STF 34-1 Steel Fix	81661809	Hooped clamp	1	30.0 – 34.0	38.0	78.0
STF 38-1 Steel Fix	81661810	Hooped clamp	1	34.0 – 38.0	42.0	82.0
STF 42-1 Steel Fix	81661811	Hooped clamp	1	38.0 – 42.0	46.0	91.0
<b>Double clamp (for two cables)</b>						
STF 12-2 Steel Fix	81661821	Hooped clamp	2	6.0 – 12.0	16.0	73.0
STF 14-2 Steel Fix	81661822	Hooped clamp	2	12.0 – 14.0	18.0	74.0
STF 16-2 Steel Fix	81661823	Hooped clamp	2	14.0 – 16.0	20.0	82.0
STF 18-2 Steel Fix	81661824	Hooped clamp	2	16.0 – 18.0	22.0	86.0
STF 20-2 Steel Fix	81661825	Hooped clamp	2	18.0 – 20.0	24.0	91.0
STF 22-2 Steel Fix	81661826	Hooped clamp	2	20.0 – 22.0	26.0	95.0
STF 26-2 Steel Fix	81661827	Hooped clamp	2	22.0 – 26.0	30.0	108.0
STF 30-2 Steel Fix	81661828	Hooped clamp	2	26.0 – 30.0	34.0	121.0
STF 34-2 Steel Fix	81661829	Hooped clamp	2	30.0 – 34.0	38.0	129.0
<b>Triple clamp (for three cables)</b>						
STF 12-3 Steel Fix	81661841	Hooped clamp	3	6.0 – 12.0	16.0	98.0
STF 14-3 Steel Fix	81661842	Hooped clamp	3	12.0 – 14.0	18.0	98.0
STF 16-3 Steel Fix	81661843	Hooped clamp	3	14.0 – 16.0	20.0	105.0
STF 18-3 Steel Fix	81661844	Hooped clamp	3	16.0 – 18.0	22.0	111.0
STF 20-3 Steel Fix	81661845	Hooped clamp	3	18.0 – 20.0	24.0	118.0
STF 22-3 Steel Fix	81661846	Hooped clamp	3	20.0 – 22.0	26.0	130.0

**MP 52/62/72 LOCK BUTTON**

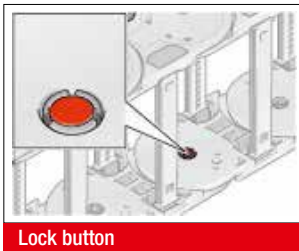

Lock button

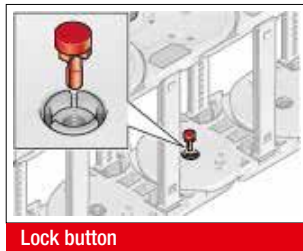

Lock button

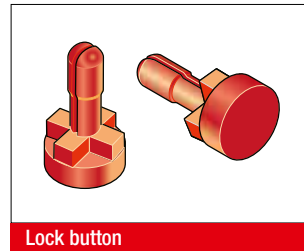

Lock button

To increase the side stability, we recommend the use of lock buttons during strong lateral acceleration or when installed

“laying on the side (turned 90°) without support”.

Type	Order No.
MP52/62/72 lock button	0520000080

**MP 52.1 REARWARD RADII**

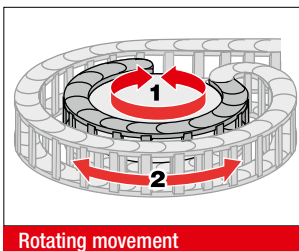

Rotating movement

Side links with rearward radius allow movements in both directions. This is intended for rotating movements and lowered chain brackets. Note: This type of chain has different chain links for the left or right side! Rotation movements are only possible with open variants.

Type	Order No.	Radius mm	Rearward radius mm
SR 52.1 (RÜ200/R300) left	052100030060	300.0	200.0
SR 52.1 (RÜ200/R300) right	052100030062	300.0	200.0

**GUIDE CHANNEL VAW (ALUMINIUM / STAINLESS STEEL)**



VAW steel galvanised / stainless steel



VAW aluminium

A range of variable guide channel systems, constructed from aluminium or stainless steel sections, are available for this energy chain.

The variable guide channel ensures that the energy chain is supported and guided securely.

**ASSEMBLY INSTRUCTION FLEXIBLE CHAIN BRACKET FB/FG**

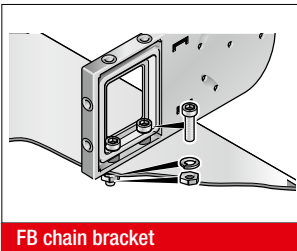

FB chain bracket

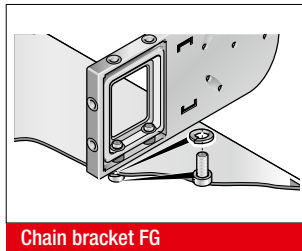

Chain bracket FG

Brass bushes guarantee long-lasting fastening without cold flow in the plastic.

**Version KA-FB:**

Integrated through-hole fastened down using screw and nut.

**Version KA-FG:**

Built-in threads allow for quick and easy on-site mounting, since a screw, including a retaining washer where necessary, is sufficient.

**ASSEMBLY**

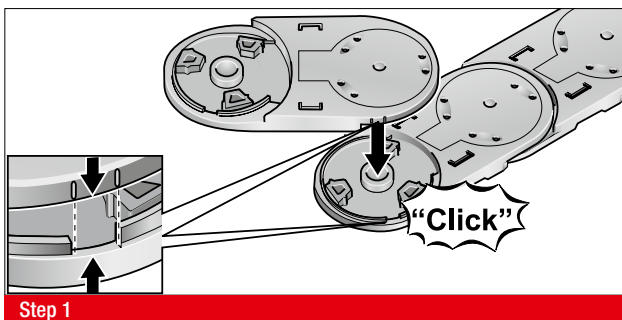

Step 1

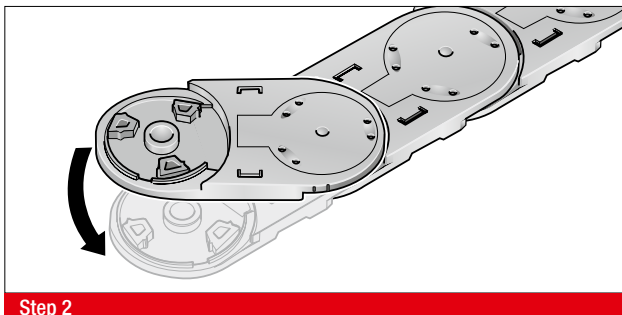

Step 2

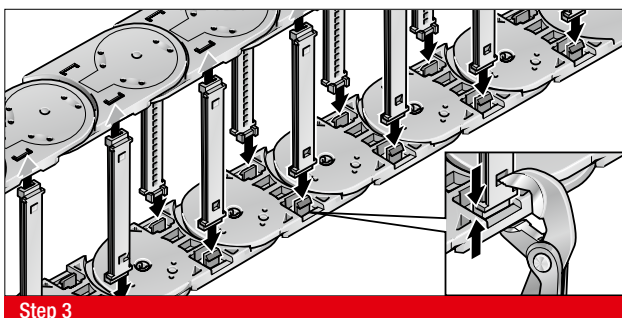

Step 3

**DISASSEMBLY**

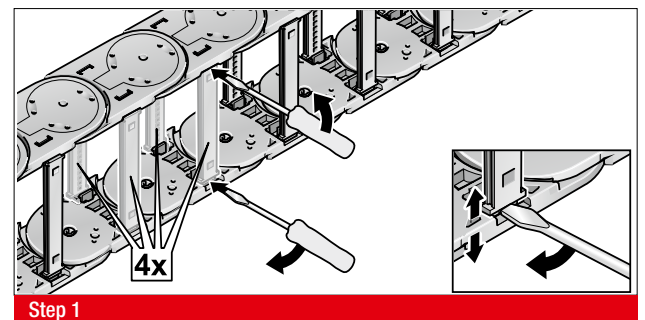

Step 1

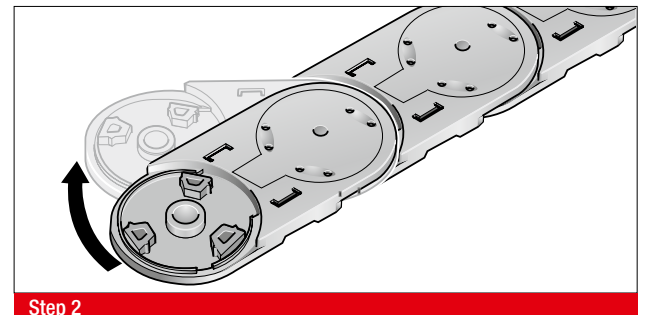

Step 2

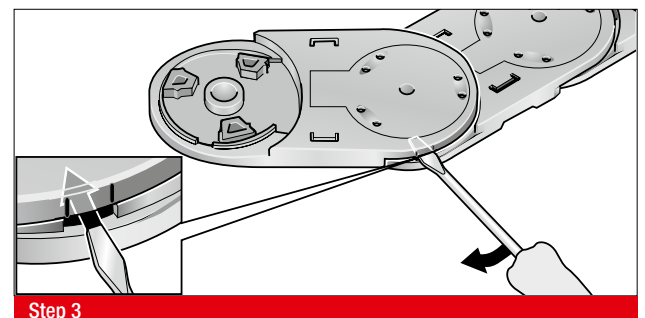

Step 3



## MP 62.1 OPEN



- PLASTIC OR ALUMINIUM VERSION
- CHAIN BRACKET FLEXIBLE

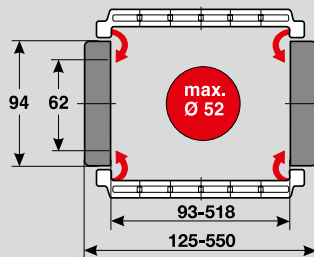

### TECHNICAL DATA

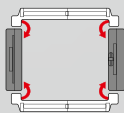

**Loading side**  
Inside and outside bend

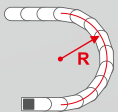

**Available radii**  
150.0 – 500.0 mm

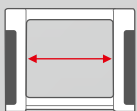

**Available interior widths**  
With plastic crossbar  
93.0 – 518.0 mm  
With alu crossbar / with alu cover  
72.0 – 600.0 mm /

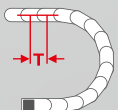

**Pitch**  
T = 100.0 mm

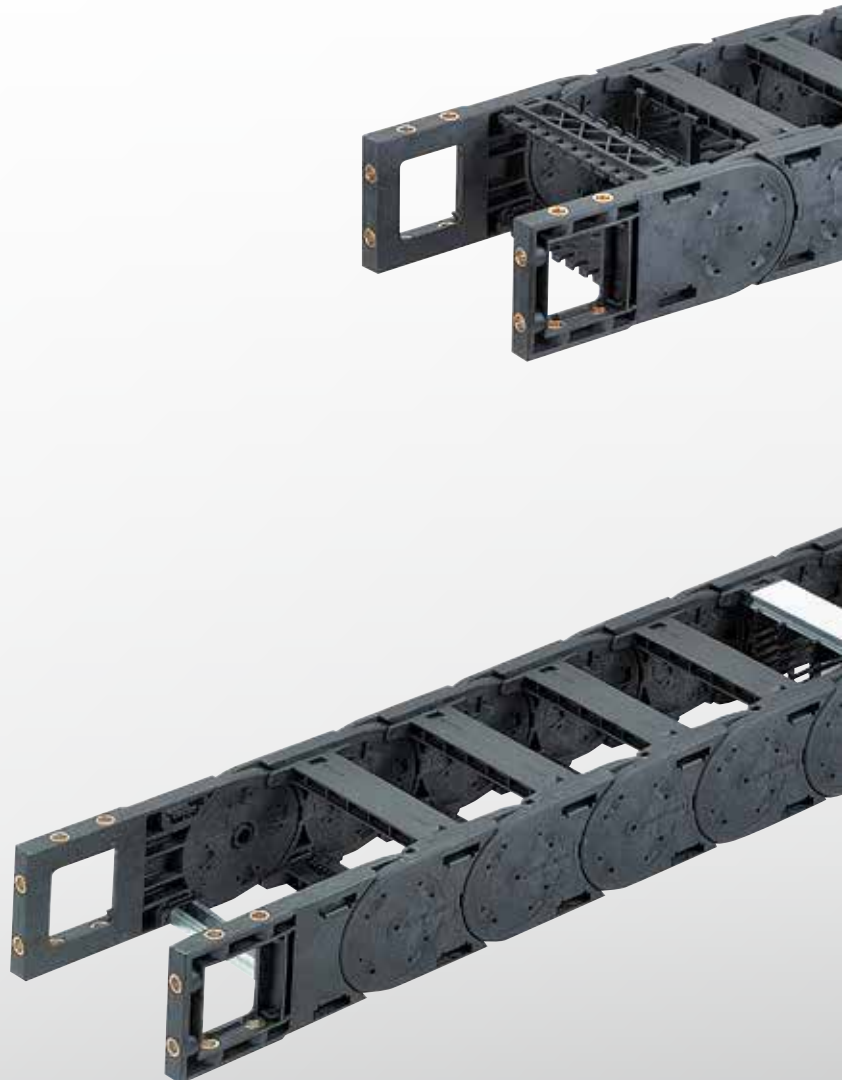





## TECHNICAL SPECIFICATIONS

Travel distance gliding $L_g$ max.	150.0 m
Travel distance self-supporting $L_s$ max.	see diagram on page 391
Travel distance vertical, hanging $L_{vh}$ max.	65.0 m
Travel distance vertical, upright $L_{vs}$ max.	6.0 m
Rotated 90°, unsupported $L_{90f}$ max.	4.0 m
Speed, gliding $V_g$ max.	5.0 m/s
Speed, self-supporting $V_f$ max.	20.0 m/s
Acceleration, gliding $a_g$ max.	25.0 m/s <sup>2</sup>
Acceleration, self-supporting $a_s$ max.	40.0 m/s <sup>2</sup>

Contact our engineering department to meet any higher requirements: [efk@murrplastik.de](mailto:efk@murrplastik.de)

## MATERIAL PROPERTIES

Standard material	Polyamide (PA) black
Service temperature	-30.0 – 120.0 °C
Gliding friction factor	0.3
Static friction factor	0.45
Fire classification	UL 94 HB

Other material properties on request.

## SHELVING SYSTEM

### CHAIN BRACKET

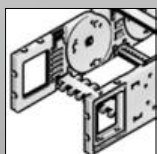

Chain bracket flexible

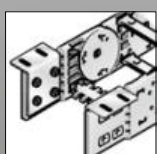

Chain bracket angle



Separator TR



RS shelving system



Crossbar connector RSV

### ACCESSORIES



Bracket bar

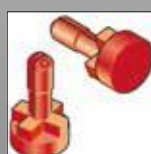

Lock button

### GUIDE CHANNELS



VAW steel galvanised / stainless steel

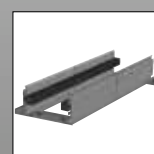

VAW aluminium

### STRAIN RELIEF

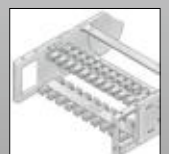

RS-ZL crossbar strain relief



STF Steel Fix

**ORDERING KEY**

Type code	Variation	Inside width	Outside width	Inside width	Outside width	Radius	Crossbar variant	Material	Chain length
<b>0621 30</b>	Crossbar on outside bend Crossbar on inside bend Opens on inside and outside bend	<b>093</b> <small>[3.66]</small>	<b>125</b> <small>[4.92]</small>	<b>468</b> <small>[18.43]</small>	<b>500</b> <small>[19.69]</small>	<b>150</b> <small>[5.91]</small>	<b>0</b> Plastic, full-ridged with bias	<b>0</b> Polyamide standard (PA/black)	
		<b>106</b> <small>[4.17]</small>	<b>138</b> <small>[5.43]</small>	<b>518</b> <small>[20.39]</small>	<b>550</b> <small>[21.65]</small>				
		<b>118</b> <small>[4.65]</small>	<b>150</b> <small>[5.91]</small>			<b>200</b> <small>[7.87]</small>	<b>1</b> Plastic, full-ridged without bias	<b>9</b> Special version (on request)	
		<b>131</b> <small>[5.16]</small>	<b>163</b> <small>[6.42]</small>						
		<b>143</b> <small>[5.63]</small>	<b>175</b> <small>[6.89]</small>			<b>250</b> <small>[9.84]</small>	<b>2</b> Plastic, half-ridged with bias		
		<b>156</b> <small>[6.14]</small>	<b>188</b> <small>[7.40]</small>						
		<b>168</b> <small>[6.61]</small>	<b>200</b> <small>[7.87]</small>			<b>300</b> <small>[11.81]</small>	<b>3</b> Plastic, half-ridged without bias		
		<b>181</b> <small>[7.13]</small>	<b>213</b> <small>[8.39]</small>						
		<b>193</b> <small>[7.60]</small>	<b>225</b> <small>[8.86]</small>			<b>400</b> <small>[15.75]</small>	<b>4</b> Aluminium full-ridged with bias		
		<b>206</b> <small>[8.11]</small>	<b>238</b> <small>[9.37]</small>						
		<b>218</b> <small>[8.58]</small>	<b>250</b> <small>[9.84]</small>			<b>500</b> <small>[19.69]</small>	<b>5</b> Aluminium full-ridged without bias		
		<b>231</b> <small>[9.09]</small>	<b>263</b> <small>[10.35]</small>						
		<b>243</b> <small>[9.57]</small>	<b>275</b> <small>[10.83]</small>				<b>6</b> Aluminium half-ridged with bias		
		<b>256</b> <small>[10.08]</small>	<b>288</b> <small>[11.34]</small>						
		<b>268</b> <small>[10.55]</small>	<b>300</b> <small>[11.81]</small>				<b>7</b> Aluminium half-ridged without bias		
		<b>293</b> <small>[11.54]</small>	<b>325</b> <small>[12.80]</small>						
		<b>318</b> <small>[12.52]</small>	<b>350</b> <small>[13.78]</small>				<b>9</b> Special version (on request)		
		<b>343</b> <small>[13.50]</small>	<b>375</b> <small>[14.76]</small>						
		<b>368</b> <small>[14.49]</small>	<b>400</b> <small>[15.75]</small>						
		<b>418</b> <small>[16.46]</small>	<b>450</b> <small>[17.72]</small>						

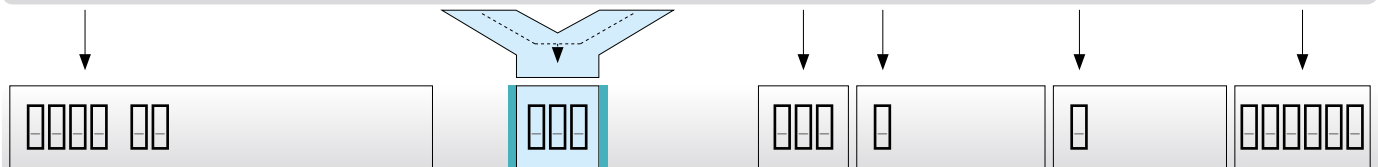

**ORDERING EXAMPLE: 0623 30 118 150 0 0 1600**

Crossbar on outside bend, crossbar on inside bend, can be opened from inside and outside bend  
 Inside width 118 mm; radius 150 mm  
 Plastic crossbar, full-ridged with bias, material black-coloured polyamide  
 Chain length 1600 mm (16 links)

**NOTE ON CONFIGURATION**

**Aluminium crossbars:**

Aluminium crossbars can be supplied in 1 mm width sizes for inner widths from 72.0 mm – 600.0 mm .

**Crossbar connector and crossbar strain relief plate:**

Once inside widths exceed 246 mm, we recommend the deployment of crossbar connectors (RSV).  
If crossbar strain relief plates (RS-ZL) are to be deployed in the chain brackets, take standard inside widths into account.

For detailed information, please consult the corresponding product documentation.

**SELF-SUPPORTING LENGTH**

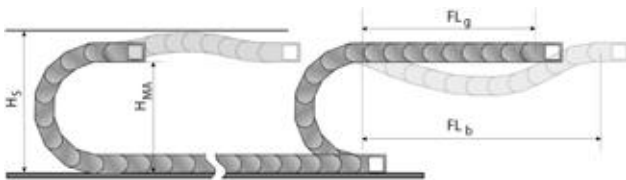

The self-supporting length is the distance between the chain bracket on the moving end and the start of the chain arch.  
The installation variant  $FL_g$  offers the lowest load and wear for the energy chain.  
The maximum travel parameters (speed and acceleration) can be applied for this variant.

- $H_s$  = Installation height plus safety
- $H_{MA}$  = Height of moving end connection
- $FL_g$  = Self-supporting length, upper run straight
- $FL_b$  = Self-supporting length, upper run bent

**LOAD DIAGRAM FOR SELF-SUPPORTING APPLICATIONS**

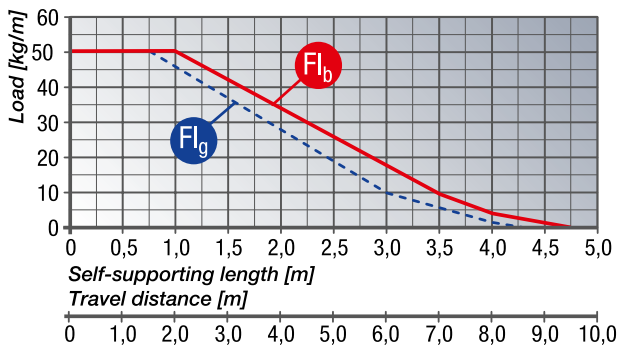

**$FL_g$  Self-supporting length, upper run straight**

In the  $FL_g$  range, the chain upper run still has a bias, is straight or has a maximum sag of 80.0 mm.

**$FL_b$  Self-supporting length, upper run bent**

In the  $FL_b$  range, the chain upper run has a sag of more than 80.0 mm, but this is still less than the maximum sag.  
Where the sag is greater than that permitted in the  $FL_b$  range, the application is critical and should be avoided. The self-supporting length can be optimised by using a support for the upper run or a more stable energy chain.

**DETERMINING THE CHAIN LENGTH**

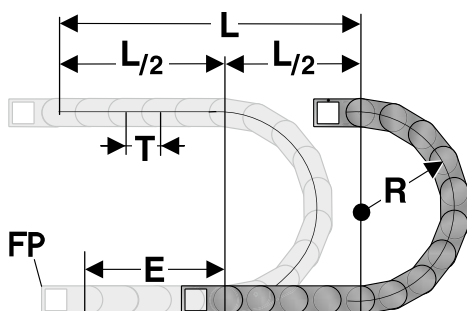

The fixed point of the energy chain should be connected in the middle of the travel distance.

This arrangement gives the shortest connection between the fixed point (FP) and the moving consumer and thus the most efficient chain length.

Chain length calculation =  $L/2 + \pi * R + E$   
 $\approx 1 \text{ m chain} = 10 \text{ qty. } \times 100.0 \text{ mm.}$

- E = Distance between entry point and middle of travel distance
- L = Travel distance
- R = Radius
- P = Pitch 100.0 mm

**INSTALLATION DIMENSIONS**

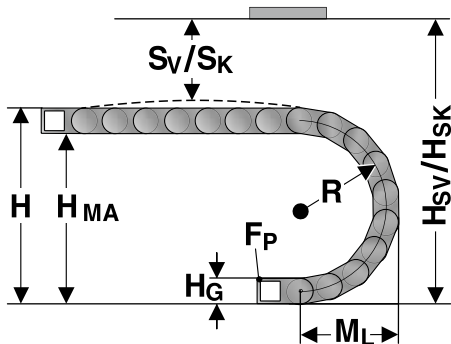

The moving end chain connection is to be screw fixed at height  $H_{MA}$  for the respective radius.

Concerning the installed dimensions, you must take into account whether the chain links are equipped with or without bias.

For chain links without bias, the “Installed height without bias  $H_{SK}$ ” value has to be taken into account.

If the chain links are equipped with a bias, the value “Installed height with bias  $H_{SV}$ ” has to be taken into account.

Radius R	150	200	250	300	400	500
Outside height of chain link ( $H_G$ )	94	94	94	94	94	94
Height of bend (H)	424	524	624	724	924	1124
Height of moving end bracket ( $H_{MA}$ )	330	430	530	630	830	1030
Safety margin with bias ( $S_v$ )	50	50	50	50	50	50
Installation height with bias ( $H_{sv}$ )	474	574	674	774	974	1174
Safety margin without bias ( $S_k$ )	20	20	20	20	20	20
Installation height without bias ( $H_{sk}$ )	444	544	644	744	944	1144
Arc projection ( $M_L$ )	312	362	412	462	562	662

**HEAVYLINE PLASTIC CROSSBAR**



Crossbar

The crossbars connect the two side runs of the energy chain. The crossbar length is synonymous with the inside width of the energy chain.

Type	Order No.	Description	Inside width mm
RS 093-7	072009300000	Crossbar	93.0
RS 106-7	072010600000	Crossbar	106.0
RS 118-7	072011800000	Crossbar	118.0
RS 131-7	072013100000	Crossbar	131.0
RS 143-7	072014300000	Crossbar	143.0
RS 156-7	072015600000	Crossbar	156.0
RS 168-7	072016800000	Crossbar	168.0
RS 181-7	072018100000	Crossbar	181.0
RS 193-7	072019300000	Crossbar	193.0
RS 206-7	072020600000	Crossbar	206.0
RS 231-7	072023100000	Crossbar	231.0
RS 243-7	072024300000	Crossbar	243.0
RS 256-7	072025600000	Crossbar	256.0
RS 268-7	072026800000	Crossbar	268.0

**HEAVYLINE PLASTIC CROSSBAR**

Type	Order No.	Description	Inside width mm
RS 293-7	072029300000	Crossbar	293.0
RS 318-7	072031800000	Crossbar	318.0
RS 343-7	072034300000	Crossbar	343.0
RS 368-7	072036800000	Crossbar	368.0
RS 418-7	072041800000	Crossbar	418.0
RS 468-7	072046800000	Crossbar	468.0
RS 518-7	072051800000	Crossbar	518.0

**KA 62.1 CHAIN BRACKET FLEXIBLE**

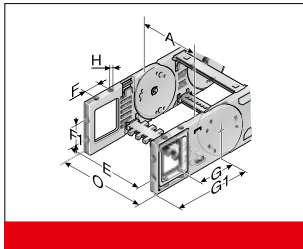

This chain bracket offers universal connection options (top, bottom and front) and is attached to the ends of the chain like a side link. This allows the chain to move right up to the bracket. Each chain requires one male and one female bracket. M8 screws are used to secure the brackets in place. Extrusion-coated metal bushes with either a through-hole (-FB) or a threaded hole (-FG) ensure the permanent, high-strength transmission of even extreme forces onto the energy chain.

Type	Order No.	Material	Version	Inside width								Outside width of KA 0 mm
				A mm	E mm	F mm	F1 mm	G mm	G1 mm	H mm	H0 mm	
KA 62-FB Female end	0620000056	Plastic	with bush	93.0 – 518.0	A+17.0	35.0	45.0	107.0	171.5	8.5	A+36.0	
KA 62-FB male end	0620000057	Plastic	with bush	93.0 – 518.0	A+17.0	35.0	45.0	107.0	171.5	8.5	A+36.0	
KA 62-FG Female end	0620000058	Plastic	with thread	93.0 – 518.0	A+17.0	35.0	45.0	107.0	171.5	M8	A+36.0	
KA 62-FG male end	0620000059	Plastic	with thread	93.0 – 518.0	A+17.0	35.0	45.0	107.0	171.5	M8	A+36.0	

**KA 62.1 CHAIN BRACKET ANGLE**

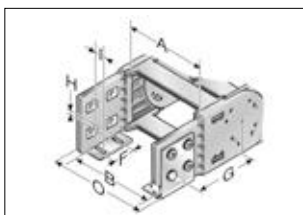

KA 62 (inside up / down)

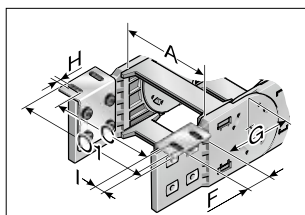

KA 62 (outside up / down)

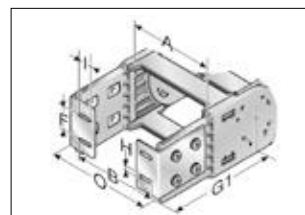

KA 62 (front inside)

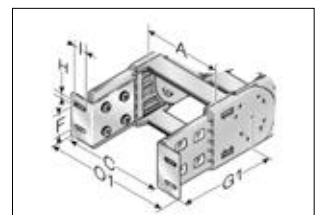

KA 62 (front outside)

This chain bracket offers universal connection options (top, bottom and front) and is attached to the ends of the chain like a side link. This allows the chain to move right up to the bracket. Each chain requires one male and one female bracket. M8

screws are used to secure the brackets in place. Metal inserts (supplied) help to minimise the cold flow properties. This is an enormous advantage, guaranteeing the smooth transfer of high loads to the chain.

Type	Order No.	Material	Inside width								Outside width of KA 0 mm	Outside width of KA 01 mm
			A mm	B mm	C mm	F mm	G mm	G1 mm	H0 mm	I mm		
KA 62 Female end	0620000050	Sheet steel	93.0 – 518.0	A-12.0	A+44.0	45.0	102.0	171.5	9.0	15.0	A+32.0	A+90.0
KA 62 Male end	0620000051	Sheet steel	93.0 – 518.0	A-12.0	A+44.0	45.0	102.0	171.5	9.0	15.0	A+32.0	A+90.0

**TR 62 SEPARATOR**

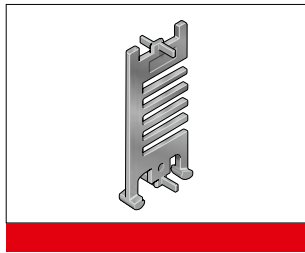
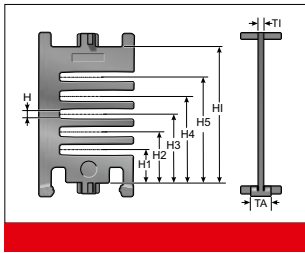

We recommend that separators be used if multiple round cables or conduits with differing diameters are to be installed.

Type	Order No.	Description	Version	TI mm	TA mm	H mm	H1 mm	H2 mm	H3 mm	H4 mm	H5 mm	Hl mm
TR 62	062000009200	Separator	lockable	3.5	13.0	5.5	14.8	23.1	31.4	39.7	48.0	62.0

**RTT 62 SHELF SUPPORT, DIVISIBLE**

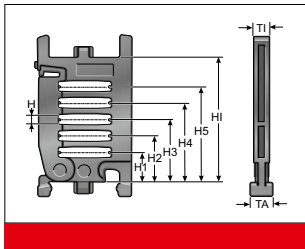

In connection with two separable shelf supports (RTT) with at least one end-to-end shelf (RB) the shelf becomes an easy to fill shelving system. The additional levels prevent cables from criss-crossing and minimise the friction between them.

Type	Order No.	Description	Version	TI mm	TA mm	H mm	H1 mm	H2 mm	H3 mm	H4 mm	H5 mm	Hl mm
RTT 62	100090622000	Shelf support, divisible	lockable	8.0	8.0	5.5	14.8	23.1	31.4	39.7	48.0	62.0

**RB-7 SHELF**

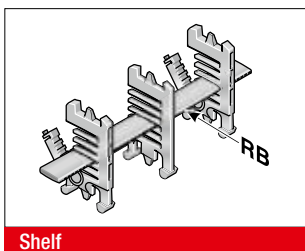

In connection with at least two separable shelf supports (RTT), the shelf becomes a shelving system. The additional levels prevent cables from criss-crossing and minimise the friction between them.

Type	Order No.	Description	Width mm	Inside width mm
RB 056-7	100000005600	Shelf	56.0	93.0
RB 061-7	1000006107	Shelf	61.0	93.0
RB 066-7	100000006600	Shelf	66.0	93.0
RB 071-7	1000007107	Shelf	71.0	93.0
RB 076-7	1000007607	Shelf	76.0	93.0
RB 081-7	10000008100	Shelf	81.0	93.0
RB 086-7	1000008607	Shelf	86.0	93.0
RB 091-7	1000009107	Shelf	91.0	106.0
RB 096-7	1000009607	Shelf	96.0	106.0
RB 101-7	1000010107	Shelf	101.0	106.0
RB 106-7	100000010600	Shelf	106.0	106.0
RB 111-7	1000011107	Shelf	111.0	118.0
RB 116-7	100000011600	Shelf	116.0	118.0
RB 121-7	1000012107	Shelf	121.0	131.0
RB 126-7	1000012607	Shelf	126.0	131.0

## RB-7 SHELF

Type	Order No.	Description	Width mm	Inside width mm
RB 131-7	1000013107	Shelf	131.0	143.0
RB 136-7	1000013607	Shelf	136.0	143.0
RB 141-7	1000014107	Shelf	141.0	143.0
RB 146-7	1000014607	Shelf	146.0	156.0
RB 151-7	1000015107	Shelf	151.0	156.0
RB 156-7	1000015607	Shelf	156.0	156.0
RB 161-7	1000016107	Shelf	161.0	168.0
RB 166-7	100000016600	Shelf	166.0	168.0
RB 171-7	1000017107	Shelf	171.0	181.0
RB 176-7	1000017607	Shelf	176.0	181.0
RB 181-7	1000018107	Shelf	181.0	193.0
RB 186-7	1000018607	Shelf	186.0	193.0
RB 191-7	1000019107	Shelf	191.0	193.0
RB 196-7	1000019607	Shelf	196.0	206.0
RB 201-7	1000020107	Shelf	201.0	206.0
RB 206-7	1000020607	Shelf	206.0	206.0
RB 211-7	1000021107	Shelf	211.0	218.0
RB 216-7	100000021600	Shelf	216.0	218.0

## CROSSBAR CONNECTOR RSV 62



For crossbars wider than 246 mm, we recommend the use of crossbar connectors. These prevent deformation to the crossbar under large amounts of additional weight of the chain assembly.

Type	Order No.	Description	Tl mm
RSV 62	062000009600	Crossbar connector	8.0
RSV 62 Alu	062000009800	Crossbar connector for aluminium crossbars	8.0

## BS-5 BRACKET BAR



Large-diameter conduits are routed securely by using a bracket bar (BS). This bar is installed on the crossbars or the covers of the energy chain.

The bracket bar can be installed on both the inside and outside bend.

The bracket bar support (BSH) is used to attach the bars to PowerLine series crossbars. Two bracket bar supports are required for each bar.

Type	Order No.	Description	Conduit diameter max. mm	Installation height mm	Inner chain width min. mm
BS 120-5	052412000000	Bracket bar	115.0	140.0	164.0
BS 153-5	052415300000	Bracket bar	148.0	170.0	208.0
BS 187-5	052418700000	Bracket bar	182.0	205.0	233.0
Assembly set	052400000001	Assembly set			

**RS-ZL-7 CROSSBAR STRAIN RELIEF PLATE**

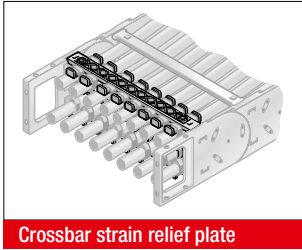

Fixed integrated frame bridge strain relief plates in the chain brackets. Accommodated to all widths of the frame bridges, up to 256 mm in size. May be assembled on the inside and outside flexure curves at both chain endings.

Type	Order No.	Description	Inside width mm
RS-ZL 093-7	072009300010	Crossbar strain relief plate	93.0
RS-ZL 106-7	072010600010	Crossbar strain relief plate	106.0
RS-ZL 118-7	072011800010	Crossbar strain relief plate	118.0
RS-ZL 131-7	072013100010	Crossbar strain relief plate	131.0
RS-ZL 143-7	072014300010	Crossbar strain relief plate	143.0
RS-ZL 156-7	072015600010	Crossbar strain relief plate	156.0
RS-ZL 168-7	072016800010	Crossbar strain relief plate	168.0
RS-ZL 181-7	072018100010	Crossbar strain relief plate	181.0
RS-ZL 193-7	072019300010	Crossbar strain relief plate	193.0
RS-ZL 206-7	072020600010	Crossbar strain relief plate	206.0
RS-ZL 218-7	072021800010	Crossbar strain relief plate	218.0
RS-ZL 231-7	072023100010	Crossbar strain relief plate	231.0
RS-ZL 243-7	072024300010	Crossbar strain relief plate	243.0
RS-ZL 256-7	072025600010	Crossbar strain relief plate	256.0

**MP 52/62/72 LOCK BUTTON**

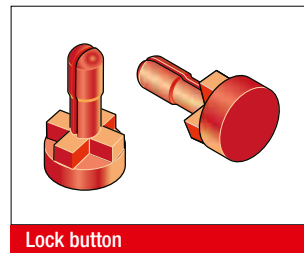
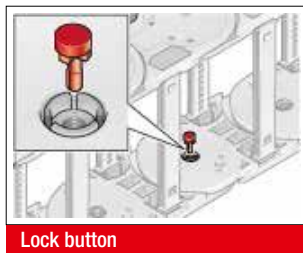
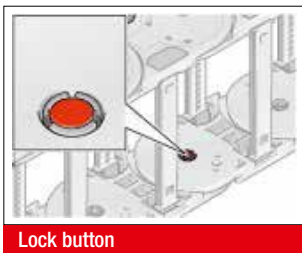

To increase the side stability, we recommend the use of lock buttons during strong lateral acceleration or when installed

“laying on the side (turned 90°) without support”.

Type	Order No.
MP52/62/72 lock button	0520000080



## STRAIN RELIEF WITH STEEL FIX

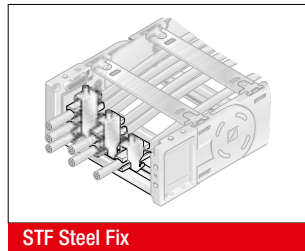
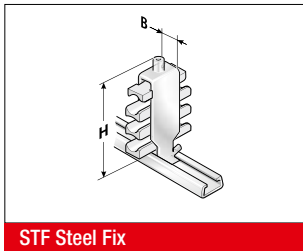

C-rails (galvanised) for permanent integration, for accommodating the Steel Fix bow clamps in the chain brackets. The bow clamps can take up to 3 cables and are suitable for C-rails with a groove width of 11 mm. Due to the design of the trough elements, a cable preserving cable guidance is ensured. May be assembled on the inside and outside bends at both chain endings. The overall height stated is a guide only. The actual height is, amongst other things, dependent on the diameter and the quality of the cable. A safety distance of 10 mm at the fixed point above the strain relief must be kept during gliding applications.

Type	Order No.	Description	Seats qty.	Cable Ø mm	Width mm	Total height (H) mm
<b>Single clamp (for one cable)</b>						
STF 12-1 Steel Fix	81661801	Hooped clamp	1	6.0 – 12.0	16.0	55.0
STF 14-1 Steel Fix	81661802	Hooped clamp	1	12.0 – 14.0	18.0	52.0
STF 16-1 Steel Fix	81661803	Hooped clamp	1	14.0 – 16.0	20.0	54.0
STF 18-1 Steel Fix	81661804	Hooped clamp	1	16.0 – 18.0	22.0	56.0
STF 20-1 Steel Fix	81661805	Hooped clamp	1	18.0 – 20.0	24.0	59.0
STF 22-1 Steel Fix	81661806	Hooped clamp	1	20.0 – 22.0	26.0	61.0
STF 26-1 Steel Fix	81661807	Hooped clamp	1	22.0 – 26.0	30.0	70.0
STF 30-1 Steel Fix	81661808	Hooped clamp	1	26.0 – 30.0	34.0	74.0
STF 34-1 Steel Fix	81661809	Hooped clamp	1	30.0 – 34.0	38.0	78.0
STF 38-1 Steel Fix	81661810	Hooped clamp	1	34.0 – 38.0	42.0	82.0
STF 42-1 Steel Fix	81661811	Hooped clamp	1	38.0 – 42.0	46.0	91.0
<b>Double clamp (for two cables)</b>						
STF 12-2 Steel Fix	81661821	Hooped clamp	2	6.0 – 12.0	16.0	73.0
STF 14-2 Steel Fix	81661822	Hooped clamp	2	12.0 – 14.0	18.0	74.0
STF 16-2 Steel Fix	81661823	Hooped clamp	2	14.0 – 16.0	20.0	82.0
STF 18-2 Steel Fix	81661824	Hooped clamp	2	16.0 – 18.0	22.0	86.0
STF 20-2 Steel Fix	81661825	Hooped clamp	2	18.0 – 20.0	24.0	91.0
STF 22-2 Steel Fix	81661826	Hooped clamp	2	20.0 – 22.0	26.0	95.0
STF 26-2 Steel Fix	81661827	Hooped clamp	2	22.0 – 26.0	30.0	108.0
STF 30-2 Steel Fix	81661828	Hooped clamp	2	26.0 – 30.0	34.0	121.0
STF 34-2 Steel Fix	81661829	Hooped clamp	2	30.0 – 34.0	38.0	129.0
<b>Triple clamp (for three cables)</b>						
STF 12-3 Steel Fix	81661841	Hooped clamp	3	6.0 – 12.0	16.0	98.0
STF 14-3 Steel Fix	81661842	Hooped clamp	3	12.0 – 14.0	18.0	98.0
STF 16-3 Steel Fix	81661843	Hooped clamp	3	14.0 – 16.0	20.0	105.0
STF 18-3 Steel Fix	81661844	Hooped clamp	3	16.0 – 18.0	22.0	111.0
STF 20-3 Steel Fix	81661845	Hooped clamp	3	18.0 – 20.0	24.0	118.0
STF 22-3 Steel Fix	81661846	Hooped clamp	3	20.0 – 22.0	26.0	130.0

**LOWERED FIXING POINT MP 62**

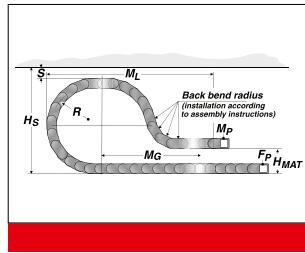
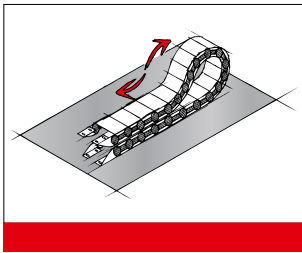

It is sometimes necessary to lower the height of the moving attachment point.

In such cases, modifications to the chain layout should be noted (e.g. extension of chain).

Please contact our application engineers.

Radius R mm	Height of moving end bracket (H <sub>MA</sub> ) mm	Safety margin (S) mm	Installation height incl. safety (H <sub>S</sub> ) mm	Projection (M <sub>L</sub> ) mm	Additional links qty.	of which additional back chain links qty.
200.0	230.0	60.0	564.0	850.0	11	2
250.0	270.0	60.0	664.0	990.0	12	2
300.0	320.0	60.0	764.0	1060.0	12	3
400.0	380.0	90.0	694.0	1060.0	14	3
500.0	440.0	60.0	1164.0	1520.0	17	3

**MP 62.1 REARWARD RADII**

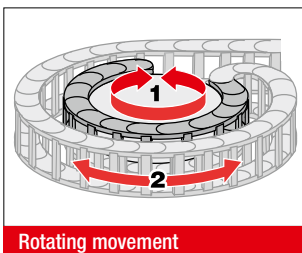

Rotating movement

Side links with rearward radius allow movements in both directions. This is intended for rotating movements and lowered chain brackets. Note: This type of chain has different chain links for the left or right side! Rotation movements are only possible with open variants.

Type	Order No.	Radius mm	Rearward radius mm
SR 62.1 (RÜ300/R300) left	062100030060	300.0	300.0
SR 62.1 (RÜ300/R300) right	062100030062	300.0	300.0

**GUIDE CHANNEL VAW (ALUMINIUM / STAINLESS STEEL)**



VAW steel galvanised / stainless steel

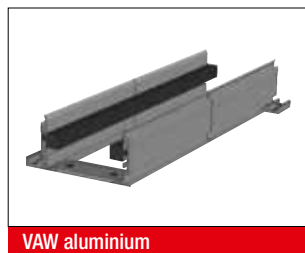

VAW aluminium

A range of variable guide channel systems, constructed from aluminium or stainless steel sections, are available for this energy chain.

The variable guide channel ensures that the energy chain is supported and guided securely.

**ASSEMBLY INSTRUCTION FLEXIBLE CHAIN BRACKET FB/FG**

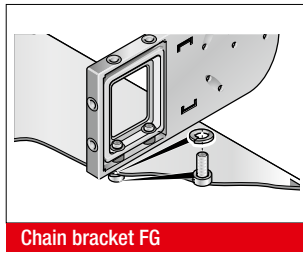
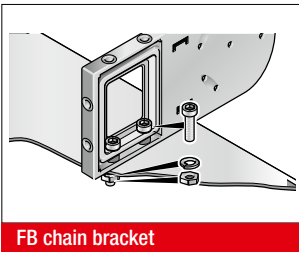

Brass bushes guarantee long-lasting fastening without cold flow in the plastic.

**Version KA-FB:**

Integrated through-hole fastened down using screw and nut.

**Version KA-FG:**

Built-in threads allow for quick and easy on-site mounting, since a screw, including a retaining washer where necessary, is sufficient.

**ASSEMBLY**

**DISASSEMBLY**

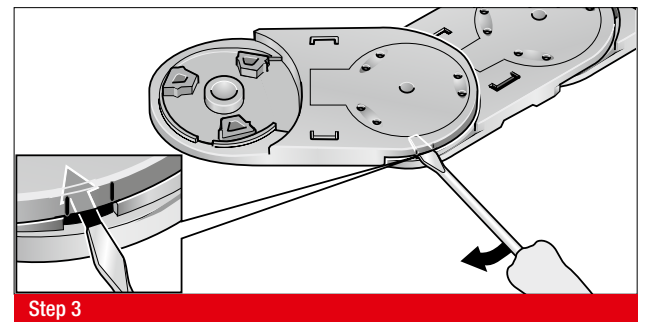
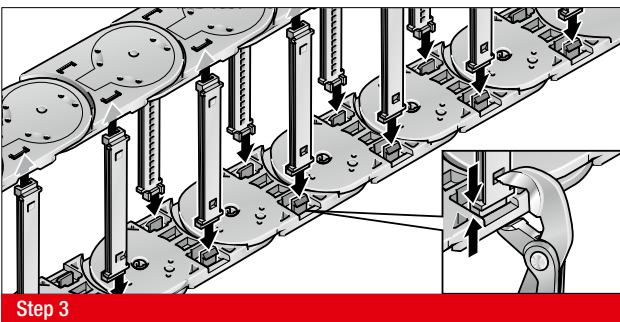
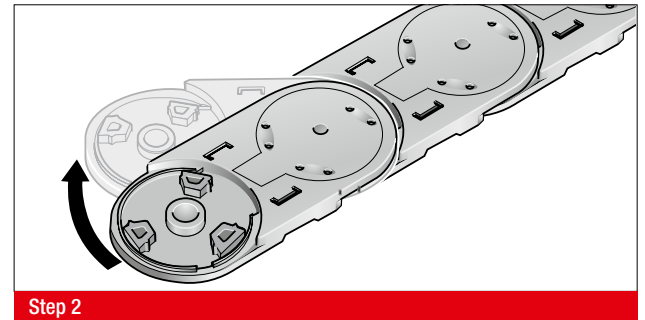
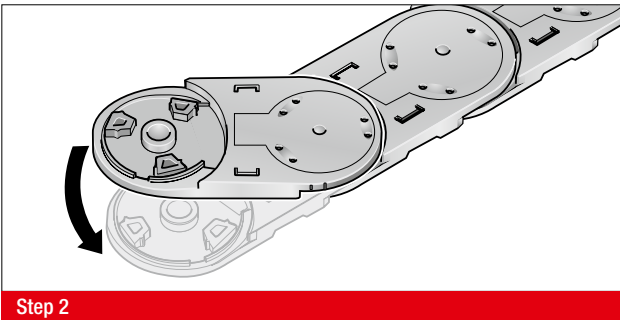
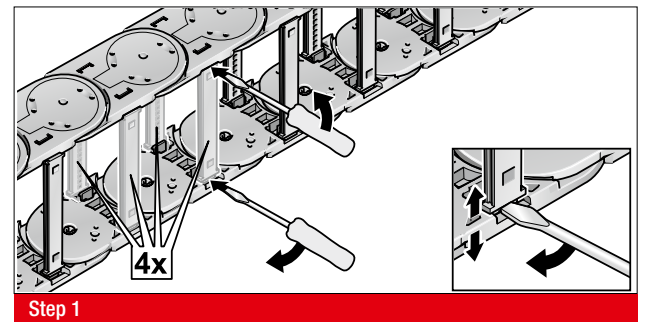
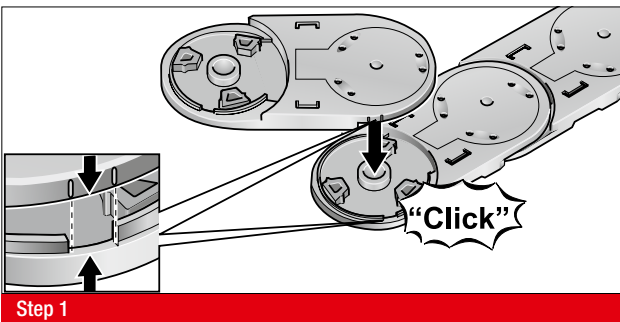

## MP 66 OPEN



- PLASTIC OR ALUMINIUM VERSION
- METAL CHAIN BRACKET
- OPENS ON INSIDE AND OUTSIDE BEND

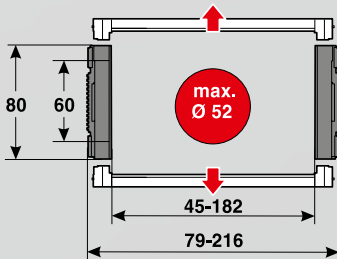

### TECHNICAL DATA

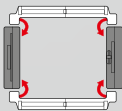

**Loading side**  
Inside and outside bend

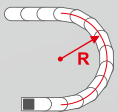

**Available radii**  
150.0 – 400.0 mm

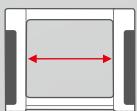

**Available interior widths**  
With plastic crossbar  
45.0 – 182.0 mm  
With alu crossbar / with alu cover  
77.0 – 600.0 mm /

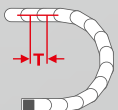

**Pitch**  
T = 91.5 mm





## TECHNICAL SPECIFICATIONS

Travel distance gliding $L_g$ max.	60.0 m
Travel distance self-supporting $L_s$ max.	see diagram on page 403
Travel distance vertical, hanging $L_{vh}$ max.	50.0 m
Travel distance vertical, upright $L_{vs}$ max.	5.0 m
Rotated 90°, unsupported $L_{90f}$ max.	2.0 m
Speed, gliding $V_g$ max.	5.0 m/s
Speed, self-supporting $V_f$ max.	15.0 m/s
Acceleration, gliding $a_g$ max.	15.0 m/s <sup>2</sup>
Acceleration, self-supporting $a_s$ max.	20.0 m/s <sup>2</sup>

Contact our engineering department to meet any higher requirements: [efk@murrplastik.de](mailto:efk@murrplastik.de)

## MATERIAL PROPERTIES

Standard material	Polyamide (PA) black
Service temperature	-30.0 – 120.0 °C
Gliding friction factor	0.3
Static friction factor	0.45
Fire classification	Based on UL 94 HB

Other material properties on request.

## CHAIN BRACKET

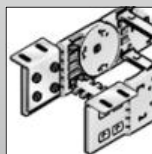

Chain bracket angle

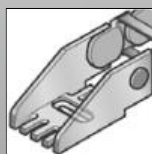

Chain bracket U-part

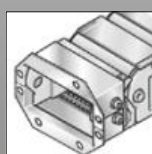

End brackets flange

## SHELVING SYSTEM

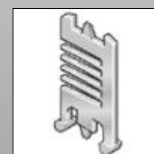

Separator TR

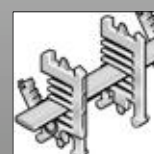

RS shelving system

## GUIDE CHANNELS



VAW aluminium

**ORDERING KEY**

Type code	Variation	Inside width	Outside width	Inside width	Outside width	Radius	Crossbar variant	Material	Chain length																																																																																																																										
<b>0660 30</b>	Crossbar on outside bend Crossbar on inside bend Opens on inside and outside bend	<b>045</b> [1.77]	<b>079</b> [3.11]			<b>150</b> [5.91]	<b>0</b> Plastic, full-ridged with bias	<b>0</b> Polyamide standard (PA/black)																																																																																																																											
		<b>062</b> [2.44]	<b>096</b> [3.78]									<b>084</b> [3.31]	<b>118</b> [4.65]			<b>200</b> [7.87]	<b>1</b> Plastic, full-ridged without bias	<b>9</b> Special version (on request)				<b>105</b> [4.13]	<b>139</b> [5.47]					<b>144</b> [5.67]	<b>178</b> [7.01]			<b>240</b> [9.45]	<b>2</b> Plastic, half-ridged with bias					<b>182</b> [7.17]	<b>216</b> [8.50]									<b>280</b> [11.02]	<b>3</b> Plastic, half-ridged without bias															<b>350</b> [13.78]	<b>4</b> Aluminium full-ridged with bias															<b>400</b> [15.75]	<b>5</b> Aluminium full-ridged without bias																<b>6</b> Aluminium half-ridged with bias																<b>7</b> Aluminium half-ridged without bias																<b>9</b> Special version (on request)		
		<b>084</b> [3.31]	<b>118</b> [4.65]			<b>200</b> [7.87]	<b>1</b> Plastic, full-ridged without bias	<b>9</b> Special version (on request)																																																																																																																											
		<b>105</b> [4.13]	<b>139</b> [5.47]									<b>144</b> [5.67]	<b>178</b> [7.01]			<b>240</b> [9.45]	<b>2</b> Plastic, half-ridged with bias					<b>182</b> [7.17]	<b>216</b> [8.50]									<b>280</b> [11.02]	<b>3</b> Plastic, half-ridged without bias															<b>350</b> [13.78]	<b>4</b> Aluminium full-ridged with bias															<b>400</b> [15.75]	<b>5</b> Aluminium full-ridged without bias																<b>6</b> Aluminium half-ridged with bias																<b>7</b> Aluminium half-ridged without bias																<b>9</b> Special version (on request)																		
		<b>144</b> [5.67]	<b>178</b> [7.01]			<b>240</b> [9.45]	<b>2</b> Plastic, half-ridged with bias																																																																																																																												
		<b>182</b> [7.17]	<b>216</b> [8.50]													<b>280</b> [11.02]	<b>3</b> Plastic, half-ridged without bias															<b>350</b> [13.78]	<b>4</b> Aluminium full-ridged with bias															<b>400</b> [15.75]	<b>5</b> Aluminium full-ridged without bias																<b>6</b> Aluminium half-ridged with bias																<b>7</b> Aluminium half-ridged without bias																<b>9</b> Special version (on request)																																		
						<b>280</b> [11.02]	<b>3</b> Plastic, half-ridged without bias																																																																																																																												
																<b>350</b> [13.78]	<b>4</b> Aluminium full-ridged with bias															<b>400</b> [15.75]	<b>5</b> Aluminium full-ridged without bias																<b>6</b> Aluminium half-ridged with bias																<b>7</b> Aluminium half-ridged without bias																<b>9</b> Special version (on request)																																																		
						<b>350</b> [13.78]	<b>4</b> Aluminium full-ridged with bias																																																																																																																												
																<b>400</b> [15.75]	<b>5</b> Aluminium full-ridged without bias																<b>6</b> Aluminium half-ridged with bias																<b>7</b> Aluminium half-ridged without bias																<b>9</b> Special version (on request)																																																																		
						<b>400</b> [15.75]	<b>5</b> Aluminium full-ridged without bias																																																																																																																												
																	<b>6</b> Aluminium half-ridged with bias																<b>7</b> Aluminium half-ridged without bias																<b>9</b> Special version (on request)																																																																																		
							<b>6</b> Aluminium half-ridged with bias																																																																																																																												
																	<b>7</b> Aluminium half-ridged without bias																<b>9</b> Special version (on request)																																																																																																		
							<b>7</b> Aluminium half-ridged without bias																																																																																																																												
																	<b>9</b> Special version (on request)																																																																																																																		
							<b>9</b> Special version (on request)																																																																																																																												

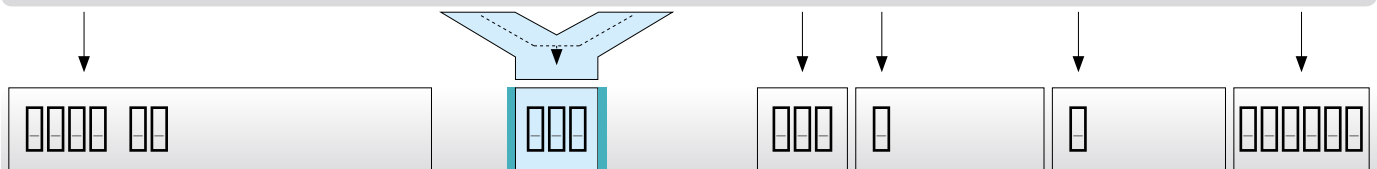

**ORDERING EXAMPLE: 0660 30 045 150 0 0 1556**

Crossbar on outside bend, crossbar on inside bend, can be opened from inside and outside bend  
 Inside width 45 mm; radius 150 mm  
 Plastic crossbar, full-ridged with bias, material black-coloured polyamide  
 Chain length 1556 mm (17 links)

**NOTE ON CONFIGURATION**

**Aluminium crossbars:**

Aluminium crossbars can be supplied in 1 mm width sizes for inner widths from 77.0 mm – 600.0 mm .

**Strain relief:**

The end brackets utilise strain relief plates (ZL) for cable strain relief.

For detailed information, please consult the corresponding product documentation.

**SELF-SUPPORTING LENGTH**

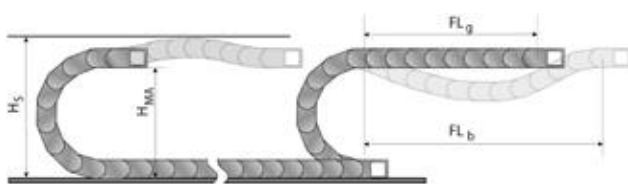

The self-supporting length is the distance between the chain bracket on the moving end and the start of the chain arch. The installation variant  $FL_g$  offers the lowest load and wear for the energy chain. The maximum travel parameters (speed and acceleration) can be applied for this variant.

- $H_s$  = Installation height plus safety
- $H_{MA}$  = Height of moving end connection
- $FL_g$  = Self-supporting length, upper run straight
- $FL_b$  = Self-supporting length, upper run bent

**LOAD DIAGRAM FOR SELF-SUPPORTING APPLICATIONS**

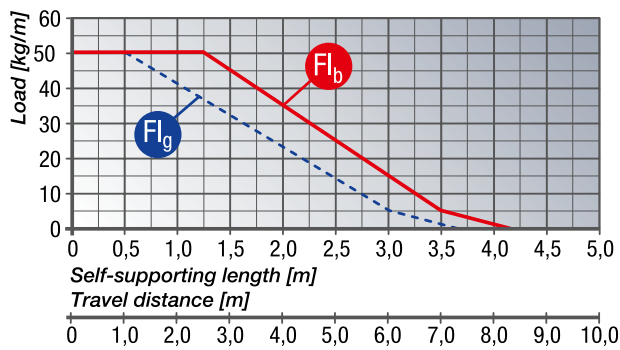

**FL<sub>g</sub> Self-supporting length, upper run straight**

In the  $FL_g$  range, the chain upper run still has a bias, is straight or has a maximum sag of 60.0 mm.

**FL<sub>b</sub> Self-supporting length, upper run bent**

In the  $FL_b$  range, the chain upper run has a sag of more than 60.0 mm, but this is still less than the maximum sag. Where the sag is greater than that permitted in the  $FL_g$  range, the application is critical and should be avoided. The self-supporting length can be optimised by using a support for the upper run or a more stable energy chain.

**DETERMINING THE CHAIN LENGTH**

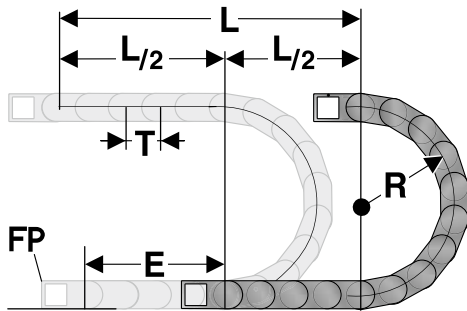

The fixed point of the energy chain should be connected in the middle of the travel distance.

This arrangement gives the shortest connection between the fixed point (FP) and the moving consumer and thus the most efficient chain length.

Chain length calculation =  $L/2 + \pi * R + E$   
 $\approx 1 \text{ m chain} = 11 \text{ qty. } \times 91.5 \text{ mm.}$

- E = Distance between entry point and middle of travel distance
- L = Travel distance
- R = Radius
- P = Pitch 91.5 mm

**INSTALLATION DIMENSIONS**

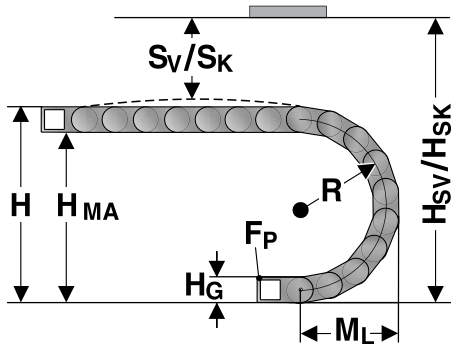

The moving end chain connection is to be screw fixed at height H<sub>MA</sub> for the respective radius.

Concerning the installed dimensions, you must take into account whether the chain links are equipped with or without bias.

For chain links without bias, the “Installed height without bias H<sub>SK</sub>” value has to be taken into account.

If the chain links are equipped with a bias, the value “Installed height with bias H<sub>SV</sub>” has to be taken into account.

Radius R	150	200	240	280	350	400
Outside height of chain link (H <sub>o</sub> )	80	80	80	80	80	80
Height of bend (H)	380	480	560	640	780	880
Height of moving end bracket (H <sub>MA</sub> )	300	400	480	560	700	800
Safety margin with bias (S <sub>v</sub> )	50	50	50	50	50	50
Installation height with bias (H <sub>SV</sub> )	430	530	610	690	830	930
Safety margin without bias (S <sub>k</sub> )	15	15	15	15	15	15
Installation height without bias (H <sub>SK</sub> )	395	495	575	655	795	895
Arc projection (M <sub>L</sub> )	282	332	372	412	482	532

**CHAIN BRACKET ANGLE KA 66**

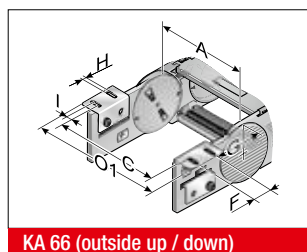
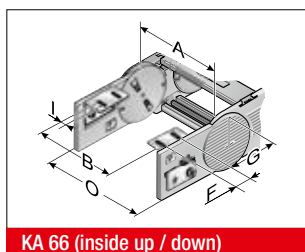

There are several options regarding the chain bracket. The fixed-point bracket (inside/bottom) and the moving end bracket (inside/top) are supplied as standard. However, any other combination can be supplied upon request. The chain bracket is fastened at the end like a side link. This enables the chain to move right up to the bracket. Each chain requires two chain brackets. The brackets should be fastened with M8 screws.

Type	Order No.	Material	Inside width							Outside width of KA 0 mm	Outside width of KA 01 mm	
			A mm	B mm	C mm	F mm	G mm	G1 mm	HØ mm			I mm
KA 66	0660000050	Sheet steel	62.0 – 182.0	A-17.0	A+51.0	45.0	50.5	86.0	9.0	10.0	A+34.0	A+64.0
KA 66	0660000060	Stainless steel 1.4301	62.0 – 182.0	A-17.0	A+51.0	45.0	50.5	86.0	9.0	10.0	A+34.0	A+64.0



**CHAIN BRACKET U-PART KA 66**

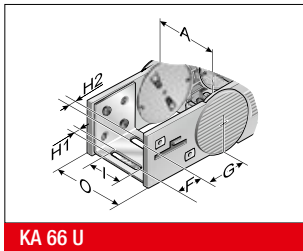

The chain bracket is an all-plastic part. The bracket is precisely adjusted to the respective chain width and only needs to be snapped in at the chain link. Please order one male and one female end bracket for each chain. The brackets should be fastened with M5 screws. The cables or conduits may be fastened with cable ties on the integrated strain relief of the chain bracket.

Type	Order No.	Material	Inside width						Outside width of KA 0 mm
			A mm	F mm	G mm	H1 mm	H2 mm	I mm	
KA 66 U	0660000054	Sheet steel	45.0	28.0	58.5	6.5	8.5	33.0	A+34.0

**END BRACKETS FLANGE KA 65 G**

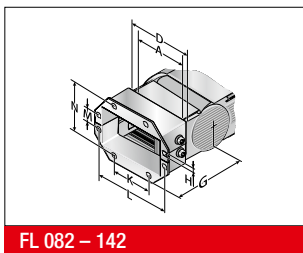

An energy chain requires two chain brackets. The divisible flange connection has been specifically designed for commissioning and re-installation. This keeps the chain in the installed position.

Type	Order No.	Material	Inside width						
			A mm	G mm	HØ mm	K mm	L mm	M mm	N mm
FL 082	0650000070	Sheet steel	86.0	136.0	7.0	78.0	141.5	40.0	105.0
FL 107	0650000072	Sheet steel	102.0	136.0	7.0	100.0	163.5	40.0	105.0
FL 142	0650000074	Sheet steel	125.0	136.0	7.0	138.0	201.5	40.0	105.0
FL 082	0650000080	Stainless steel 1.4301	86.0	136.0	7.0	78.0	141.5	40.0	105.0
FL 107	0650000082	Stainless steel 1.4301	102.0	136.0	7.0	100.0	163.5	40.0	105.0
FL 142	0650000084	Stainless steel 1.4301	125.0	136.0	7.0	138.0	201.5	40.0	105.0

**SEPARATOR TR 66**

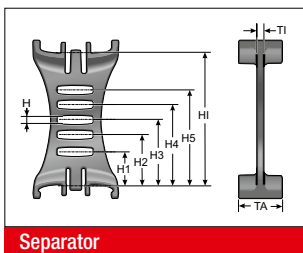

We recommend that separators be used if multiple round cables or conduits with differing diameters are to be installed.

Type	Order No.	Description	Version	Dimensions								
				TI mm	TA mm	H mm	H1 mm	H2 mm	H3 mm	H4 mm	H5 mm	H1 mm
TV 66	066000009000	Separator	lockable	3.5	20.0	4.4	15.8	22.9	30.0	37.1	44.2	60.0

**SHELVING SYSTEM MP 66**

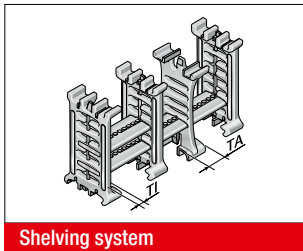

Shelving system

The shelf must be used with a minimum of two shelf supports to create a shelving system. The additional levels prevent cables from criss-crossing and minimise the friction between them. The shelving system may be preassembled on request.

Type	Order No.	Description	Width mm	Clearance width mm	Pitch mm	T1 mm	H1 mm	H2 mm	H3 mm	H4 mm	H5 mm	H6 mm	H7 mm
RB 031	100000003100	Shelf	42.0	31.0	1.6								
RB 048	100000004800	Shelf	59.0	48.0	1.6								
RB 070	100000007000	Shelf	81.0	70.0	1.6								
RB 092	100000009200	Shelf	103.0	92.0	1.6								
RB 100	100000010000	Shelf	111.0	100.0	1.6								
RB 128	100000012800	Shelf	139.0	128.0	1.6								
RB 167	100000016700	Shelf	178.0	167.0	1.6								
RT 66	1000900100	Shelf support	4.3		1.6	6.5	8.7	15.8	22.9	30.0	37.1	44.2	51.3

**MP 66 REARWARD RADII**

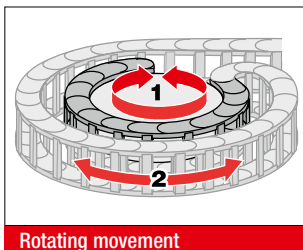

Rotating movement

Side links with rearward radius allow movements in both directions. This is intended for rotating movements and lowered chain brackets. Rotation movements are only possible with open variants.

Type	Order No.	Rearward radius mm	Version
SR 66 (RÜ240)	066000000060	240.0	Available for radii 150, 200, 240, 280 and 350 mm

**GUIDE CHANNEL VAW (ALUMINIUM)**



VAW aluminium

A variable guide channel system, constructed from aluminium sections, is available for this energy chain. The variable guide channel ensures that the energy chain is supported and guided securely.

ASSEMBLY

DISASSEMBLY

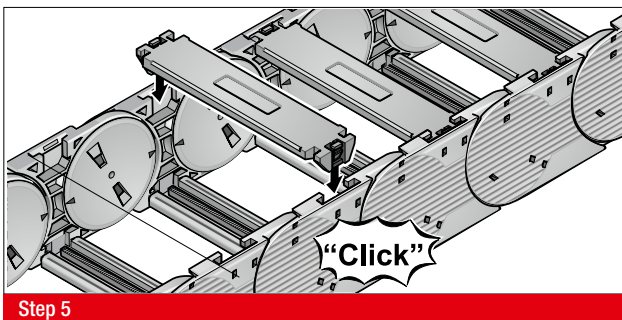
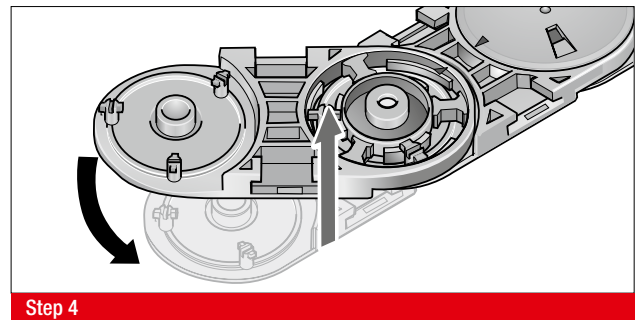
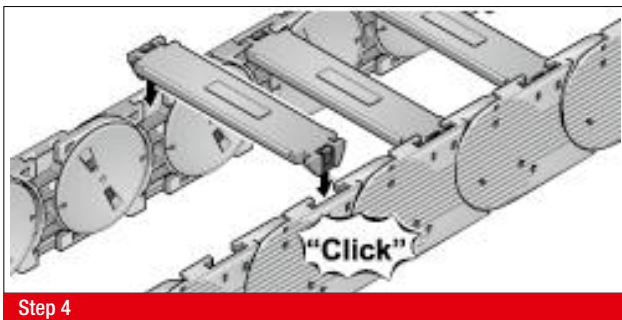
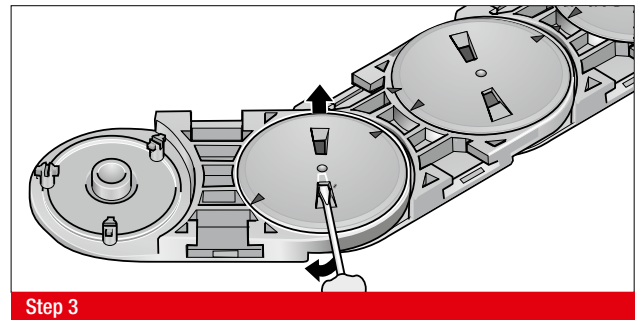
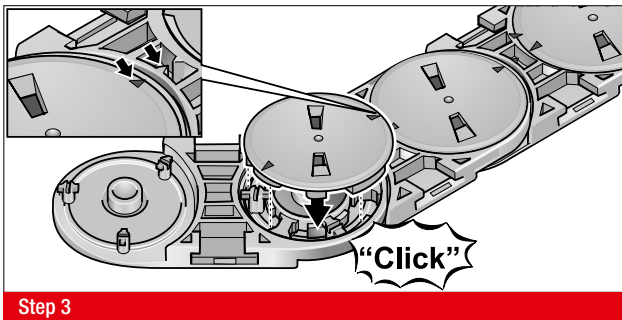
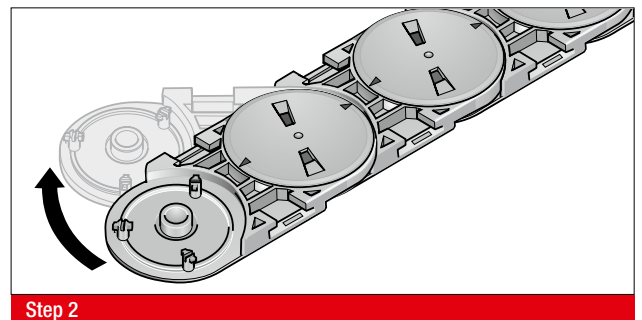
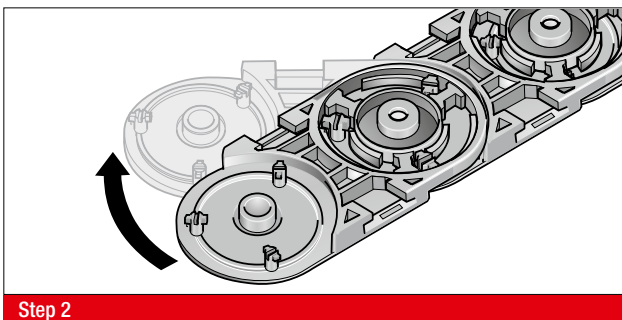
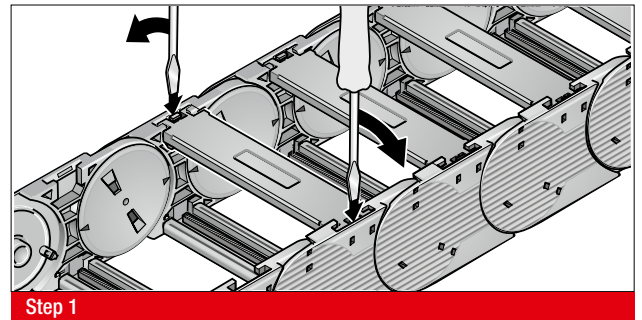
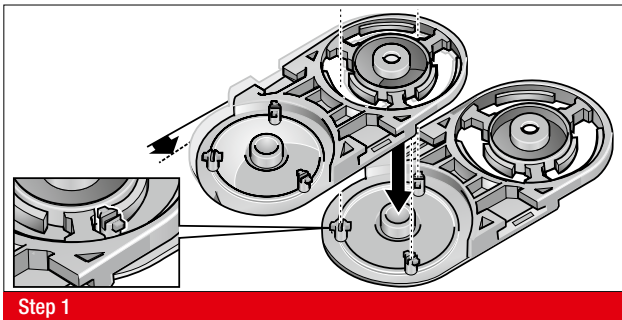

## MP 72 OPEN



- PLASTIC OR ALUMINIUM VERSION
- CHAIN BRACKET FLEXIBLE

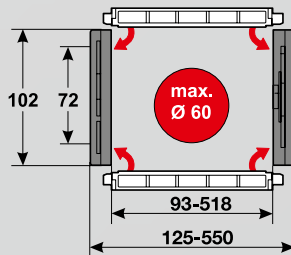

### TECHNICAL DATA

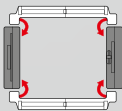

**Loading side**  
Inside and outside bend

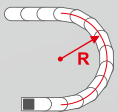

**Available radii**  
150.0 – 500.0 mm

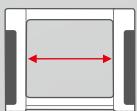

**Available interior widths**  
With plastic crossbar  
93.0 – 518.0 mm  
With alu crossbar / with alu cover  
72.0 – 600.0 mm /

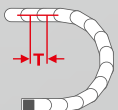

**Pitch**  
T = 100.0 mm





## TECHNICAL SPECIFICATIONS

Travel distance gliding $L_g$ max.	150.0 m
Travel distance self-supporting $L_s$ max.	see diagram on page 411
Travel distance vertical, hanging $L_{vh}$ max.	80.0 m
Travel distance vertical, upright $L_{vs}$ max.	6.0 m
Rotated 90°, unsupported $L_{90f}$ max.	6.0 m
Speed, gliding $V_g$ max.	5.0 m/s
Speed, self-supporting $V_f$ max.	20.0 m/s
Acceleration, gliding $a_g$ max.	25.0 m/s <sup>2</sup>
Acceleration, self-supporting $a_s$ max.	40.0 m/s <sup>2</sup>

Contact our engineering department to meet any higher requirements: [efk@murrplastik.de](mailto:efk@murrplastik.de)

## MATERIAL PROPERTIES

Standard material	Polyamide (PA) black
Service temperature	-30.0 – 120.0 °C
Gliding friction factor	0.3
Static friction factor	0.45
Fire classification	UL 94 HB

Other material properties on request.

### SHELVING SYSTEM



Separator TR

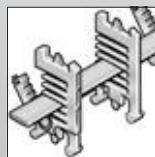

RS shelving system

### CHAIN BRACKET

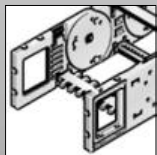

Chain bracket flexible



Crossbar connector RSV

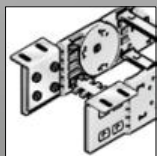

Chain bracket angle

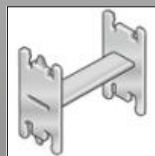

H-shaped shelf unit RE

### ACCESSORIES

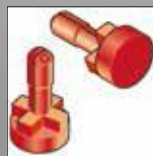

Lock button

### GUIDE CHANNELS



VAW steel galvanised / stainless steel

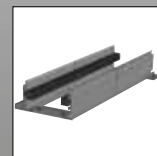

VAW aluminium

### STRAIN RELIEF



RS-ZL crossbar strain relief

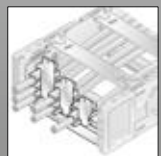

STF Steel Fix

ORDERING KEY

Type code	Variation	Inside width	Outside width	Inside width	Outside width	Radius	Crossbar variant	Material	Chain length
<b>0720 30</b>	Crossbar on outside bend Crossbar on inside bend Opens on inside and outside bend	<b>093</b> [3.66]	<b>125</b> [4.92]	<b>468</b> [18.43]	<b>500</b> [19.69]	<b>150</b> [5.91]	<b>0</b> Plastic, full-ridged with bias	<b>0</b> Polyamide standard (PA/black)	
		<b>106</b> [4.17]	<b>138</b> [5.43]	<b>518</b> [20.39]	<b>550</b> [21.65]				
		<b>118</b> [4.65]	<b>150</b> [5.91]			<b>200</b> [7.87]	<b>2</b> Plastic, half-ridged with bias	<b>9</b> Special version (on request)	
		<b>131</b> [5.16]	<b>163</b> [6.42]						
		<b>143</b> [5.63]	<b>175</b> [6.89]			<b>250</b> [9.84]	<b>4</b> Aluminium full-ridged with bias		
		<b>156</b> [6.14]	<b>188</b> [7.40]						
		<b>168</b> [6.61]	<b>200</b> [7.87]			<b>300</b> [11.81]	<b>6</b> Aluminium half-ridged with bias		
		<b>181</b> [7.13]	<b>213</b> [8.39]						
		<b>193</b> [7.60]	<b>225</b> [8.86]			<b>400</b> [15.75]	<b>9</b> Special version (on request)		
		<b>206</b> [8.11]	<b>238</b> [9.37]						
		<b>218</b> [8.58]	<b>250</b> [9.84]			<b>500</b> [19.69]			
		<b>231</b> [9.09]	<b>263</b> [10.35]						
		<b>243</b> [9.57]	<b>275</b> [10.83]						
		<b>256</b> [10.08]	<b>288</b> [11.34]						
		<b>268</b> [10.55]	<b>300</b> [11.81]						
		<b>293</b> [11.54]	<b>325</b> [12.80]						
		<b>318</b> [12.52]	<b>350</b> [13.78]						
		<b>343</b> [13.50]	<b>375</b> [14.76]						
		<b>368</b> [14.49]	<b>400</b> [15.75]						
		<b>418</b> [16.46]	<b>450</b> [17.72]						

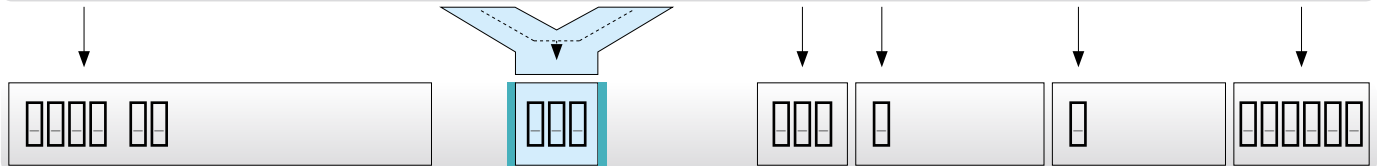

ORDERING EXAMPLE: 0720 30 118 150 0 0 1600

Crossbar on outside bend, crossbar on inside bend, can be opened from inside and outside bend  
 Inside width 118 mm; radius 150 mm  
 Plastic crossbar, full-ridged with bias, material black-coloured polyamide  
 Chain length 1600 mm (16 links)

**NOTE ON CONFIGURATION**

**Aluminium crossbars:**

Aluminium crossbars can be supplied in 1 mm width sizes for inner widths from 72.0 mm – 600.0 mm .

**Crossbar connector and crossbar strain relief plate:**

Once inside widths exceed 246 mm, we recommend the deployment of crossbar connectors (RSV).  
If crossbar strain relief plates (RS-ZL) are to be deployed in the chain brackets, take standard inside widths into account.

For detailed information, please consult the corresponding product documentation.

**SELF-SUPPORTING LENGTH**

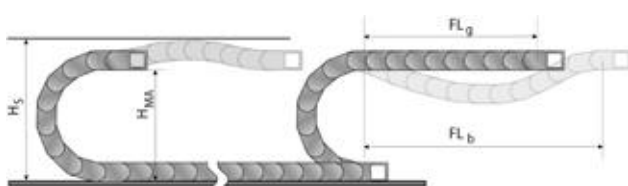

The self-supporting length is the distance between the chain bracket on the moving end and the start of the chain arch. The installation variant  $FL_g$  offers the lowest load and wear for the energy chain. The maximum travel parameters (speed and acceleration) can be applied for this variant.

- $H_s$  = Installation height plus safety
- $H_{MA}$  = Height of moving end connection
- $FL_g$  = Self-supporting length, upper run straight
- $FL_b$  = Self-supporting length, upper run bent

**LOAD DIAGRAM FOR SELF-SUPPORTING APPLICATIONS**

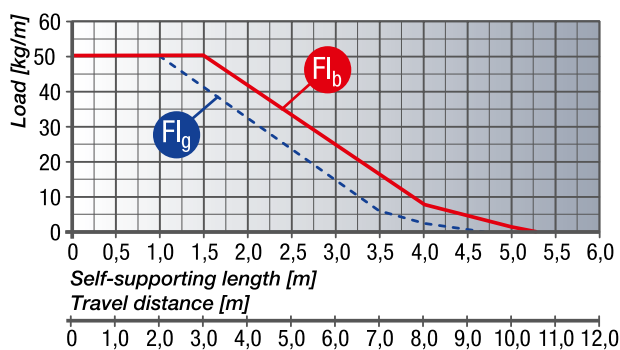

**$FL_g$  Self-supporting length, upper run straight**

In the  $FL_g$  range, the chain upper run still has a bias, is straight or has a maximum sag of 80.0 mm.

**$FL_b$  Self-supporting length, upper run bent**

In the  $FL_b$  range, the chain upper run has a sag of more than 80.0 mm, but this is still less than the maximum sag. Where the sag is greater than that permitted in the  $FL_b$  range, the application is critical and should be avoided. The self-supporting length can be optimised by using a support for the upper run or a more stable energy chain.

**DETERMINING THE CHAIN LENGTH**

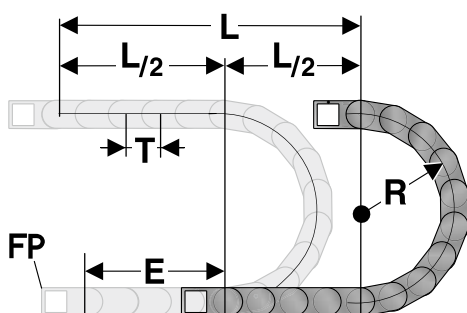

The fixed point of the energy chain should be connected in the middle of the travel distance.

This arrangement gives the shortest connection between the fixed point (FP) and the moving consumer and thus the most efficient chain length.

Chain length calculation =  $L/2 + \pi * R + E$   
 $\approx 1 \text{ m chain} = 10 \text{ qty. } \times 100.0 \text{ mm.}$

- E = Distance between entry point and middle of travel distance
- L = Travel distance
- R = Radius
- P = Pitch 100.0 mm

**INSTALLATION DIMENSIONS**

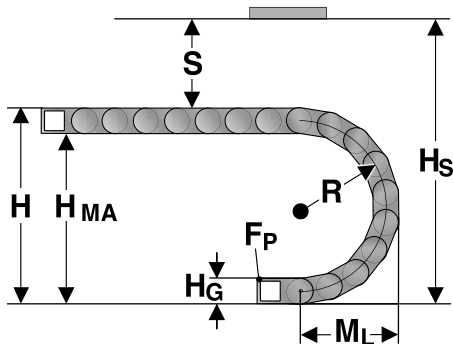

The moving end chain connection is to be screw fixed at height  $H_{MA}$  for the respective radius.  
For the installed dimension the “Installed height  $H_S$ ” value has to be taken into account.

Radius R	150	200	250	300	400	500
Outside height of chain link ( $H_G$ )	102	102	102	102	102	102
Height of bend (H)	422	522	622	722	922	1122
Height of moving end bracket ( $H_{MA}$ )	320	420	520	620	820	1020
Safety margin (S)	20	20	20	20	20	20
Installation height ( $H_S$ )	442	542	642	742	942	1142
Arc projection ( $M_L$ )	311	361	411	461	561	661

**HEAVYLINE PLASTIC CROSSBAR**



The crossbars connect the two side runs of the energy chain.  
The crossbar length is synonymous with the inside width of the energy chain.

Type	Order No.	Description	Inside width mm
RS 093-7	072009300000	Crossbar	93.0
RS 106-7	072010600000	Crossbar	106.0
RS 118-7	072011800000	Crossbar	118.0
RS 131-7	072013100000	Crossbar	131.0
RS 143-7	072014300000	Crossbar	143.0
RS 156-7	072015600000	Crossbar	156.0
RS 168-7	072016800000	Crossbar	168.0
RS 181-7	072018100000	Crossbar	181.0
RS 193-7	072019300000	Crossbar	193.0
RS 206-7	072020600000	Crossbar	206.0
RS 231-7	072023100000	Crossbar	231.0
RS 243-7	072024300000	Crossbar	243.0
RS 256-7	072025600000	Crossbar	256.0
RS 268-7	072026800000	Crossbar	268.0
RS 293-7	072029300000	Crossbar	293.0
RS 318-7	072031800000	Crossbar	318.0
RS 343-7	072034300000	Crossbar	343.0
RS 368-7	072036800000	Crossbar	368.0
RS 418-7	072041800000	Crossbar	418.0
RS 468-7	072046800000	Crossbar	468.0
RS 518-7	072051800000	Crossbar	518.0



**KA 72 CHAIN BRACKET FLEXIBLE**

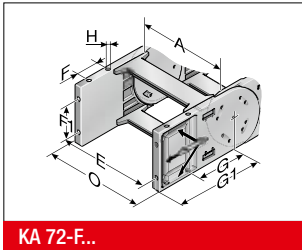

KA 72-F...

This chain bracket offers universal connection options (top, bottom and front) and is attached to the ends of the chain like a side link. This allows the chain to move right up to the bracket. Each chain requires one male and one female bracket. M10 bolts are used to secure the brackets in place. Metal inserts (supplied) help to minimize the cold flow properties. This is an enormous advantage, guaranteeing the smooth transfer of high loads to the chain.

Type	Order No.	Material	Version	Inside width							Outside width of KA 0 mm
				A mm	E mm	F mm	F1 mm	G mm	G1 mm	HØ mm	
KA 72-F Female end	0720000054	Plastic	with bush	93.0 – 518.0	A+11.0	35.0	45.0	107.0	171.5	11.0	A+32.0
KA 72-F male end	0720000055	Plastic	with bush	93.0 – 518.0	A+11.0	35.0	45.0	107.0	171.5	11.0	A+32.0

**CHAIN BRACKET ANGLE KA 72**

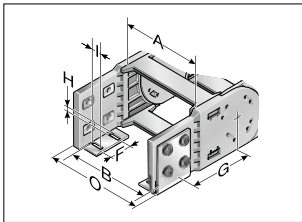

KA 72 (inside up / down)

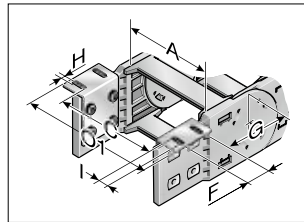

KA 72 (outside up / down)

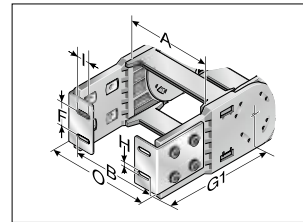

KA 72 (front inside)

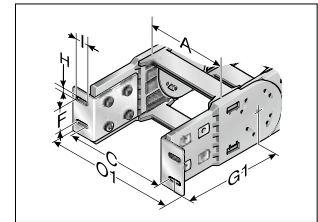

KA 72 (front outside)

There are several options regarding the chain bracket. The fixed-point bracket (inside/bottom) and the moving end bracket (inside/top) are supplied as standard. However, any other combination can be supplied upon request. The chain bracket is

fastened at the end like a side link. This enables the chain to move right up to the bracket. Each chain requires one male and one female bracket. The brackets should be fastened with M8 screws.

Type	Order No.	Material	Inside width								Outside width of KA 0 mm	Outside width of KA 01 mm
			A mm	B mm	C mm	F mm	G mm	G1 mm	HØ mm	I mm		
KA 72 Female end	0720000050	Sheet steel	93.0 – 518.0	A-16.0	A+48.0	45.0	106.0	179.5	9.0	32.0	A+32.0	A+126.0
KA 72 Male end	0720000051	Sheet steel	93.0 – 518.0	A-16.0	A+48.0	45.0	106.0	179.5	9.0	32.0	A+32.0	A+126.0

**SEPARATOR TR 72**

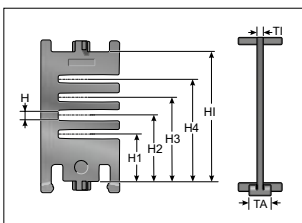

Separator

We recommend that separators be used if multiple round cables or conduits with differing diameters are to be installed.

Type	Order No.	Description	Version	TI mm	TA mm	H mm	H1 mm	H2 mm	H3 mm	H4 mm	HI mm
TR 72	072000009200	Separator	lockable	3.5	13.0	5.5	25.5	36.0	46.5	57.0	72.0

### RTT 72 SHELF SUPPORT, DIVISIBLE

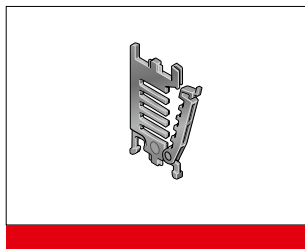
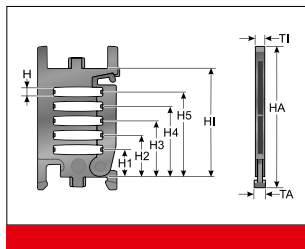

In connection with two separable shelf supports (RTT) with at least one end-to-end shelf (RB) the shelf becomes an easy to fill shelving system. The additional levels prevent cables from criss-crossing and minimise the friction between them.

Type	Order No.	Description	Version	TI mm	TA mm	H mm	H1 mm	H2 mm	H3 mm	H4 mm	H5 mm	HI mm
RTT 72	100090722000	Shelf support, divisible	lockable	8.0	8.0	5.5	15.0	25.5	36.0	46.5	57.0	72.0

### RB-7 SHELF

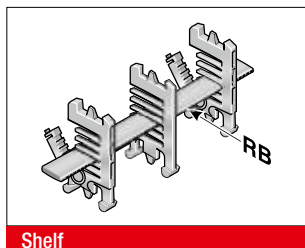

In connection with at least two separable shelf supports (RTT), the shelf becomes a shelving system. The additional levels prevent cables from criss-crossing and minimise the friction between them.

Type	Order No.	Description	Width mm	Inside width mm
RB 056-7	100000005600	Shelf	56.0	93.0
RB 061-7	1000006107	Shelf	61.0	93.0
RB 066-7	100000006600	Shelf	66.0	93.0
RB 071-7	1000007107	Shelf	71.0	93.0
RB 076-7	1000007607	Shelf	76.0	93.0
RB 081-7	10000008100	Shelf	81.0	93.0
RB 086-7	1000008607	Shelf	86.0	93.0
RB 091-7	1000009107	Shelf	91.0	106.0
RB 096-7	1000009607	Shelf	96.0	106.0
RB 101-7	1000010107	Shelf	101.0	106.0
RB 106-7	100000010600	Shelf	106.0	106.0
RB 111-7	1000011107	Shelf	111.0	118.0
RB 116-7	100000011600	Shelf	116.0	118.0
RB 121-7	1000012107	Shelf	121.0	131.0
RB 126-7	1000012607	Shelf	126.0	131.0
RB 131-7	1000013107	Shelf	131.0	143.0
RB 136-7	1000013607	Shelf	136.0	143.0
RB 141-7	1000014107	Shelf	141.0	143.0
RB 146-7	1000014607	Shelf	146.0	156.0
RB 151-7	1000015107	Shelf	151.0	156.0

**RB-7 SHELF**

Type	Order No.	Description	Width mm	Inside width mm
RB 156-7	1000015607	Shelf	156.0	156.0
RB 161-7	1000016107	Shelf	161.0	168.0
RB 166-7	100000016600	Shelf	166.0	168.0
RB 171-7	1000017107	Shelf	171.0	181.0
RB 176-7	1000017607	Shelf	176.0	181.0
RB 181-7	1000018107	Shelf	181.0	193.0
RB 186-7	1000018607	Shelf	186.0	193.0
RB 191-7	1000019107	Shelf	191.0	193.0
RB 196-7	1000019607	Shelf	196.0	206.0
RB 201-7	1000020107	Shelf	201.0	206.0
RB 206-7	1000020607	Shelf	206.0	206.0
RB 211-7	1000021107	Shelf	211.0	218.0
RB 216-7	100000021600	Shelf	216.0	218.0

**CROSSBAR CONNECTOR RSV 72**



Crossbar connector

For crossbars wider than 246 mm, we recommend the use of crossbar connectors. These prevent deformation to the crossbar under large amounts of additional weight of the chain assembly.

Type	Order No.	Description	Tl mm
RSV 72	072000009600	Crossbar connector	8.0
RSV 72 Alu	072000009800	Crossbar connector for aluminium crossbars	8.0

**RE 72 H-SHAPED SHELF UNIT**

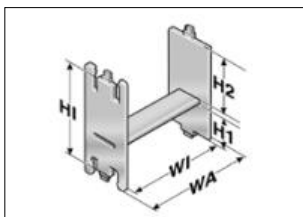

Shelf unit

One-piece shelving system, the shelf cannot be varied in height.

Type	Order No.	Description	WA mm	WI mm	H1 mm	H2 mm	HI mm
RE 75/24	100000752418	H-shaped shelf unit	75.0	67.5	43.0	24.0	72.0
RE 75/36	100000753618	H-shaped shelf unit	75.0	67.5	33.5	33.5	72.0

**RS-ZL-7 CROSSBAR STRAIN RELIEF PLATE**

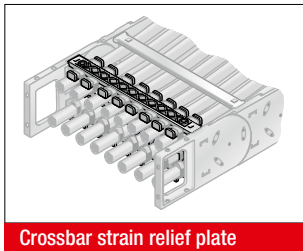

Fixed integrated frame bridge strain relief plates in the chain brackets. Accommodated to all widths of the frame bridges, up to 256 mm in size. May be assembled on the inside and outside flexure curves at both chain endings.

Type	Order No.	Description	Inside width mm
RS-ZL 093-7	072009300010	Crossbar strain relief plate	93.0
RS-ZL 106-7	072010600010	Crossbar strain relief plate	106.0
RS-ZL 118-7	072011800010	Crossbar strain relief plate	118.0
RS-ZL 131-7	072013100010	Crossbar strain relief plate	131.0
RS-ZL 143-7	072014300010	Crossbar strain relief plate	143.0
RS-ZL 156-7	072015600010	Crossbar strain relief plate	156.0
RS-ZL 168-7	072016800010	Crossbar strain relief plate	168.0
RS-ZL 181-7	072018100010	Crossbar strain relief plate	181.0
RS-ZL 193-7	072019300010	Crossbar strain relief plate	193.0
RS-ZL 206-7	072020600010	Crossbar strain relief plate	206.0
RS-ZL 218-7	072021800010	Crossbar strain relief plate	218.0
RS-ZL 231-7	072023100010	Crossbar strain relief plate	231.0
RS-ZL 243-7	072024300010	Crossbar strain relief plate	243.0
RS-ZL 256-7	072025600010	Crossbar strain relief plate	256.0

**STRAIN RELIEF WITH STEEL FIX**

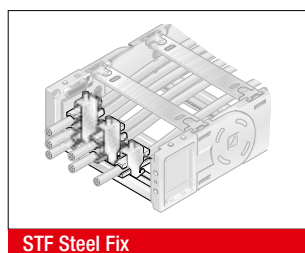
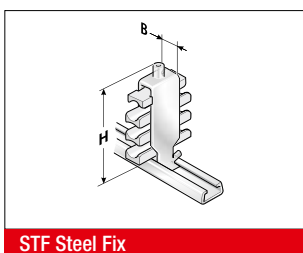

C-rails (galvanised) for permanent integration, for accommodating the Steel Fix bow clamps in the chain brackets. The bow clamps can take up to 3 cables and are suitable for C-rails with a groove width of 11 mm. Due to the design of the trough elements, a cable preserving cable guidance is ensured. May be assembled on the inside and outside bends at both chain endings. The overall height stated is a guide only. The actual height is, amongst other things, dependent on the diameter and the quality of the cable. A safety distance of 10 mm at the fixed point above the strain relief must be kept during gliding applications.

Type	Order No.	Description	Seats qty.	Cable Ø mm	Width mm	Total height (H) mm
<b>Single clamp (for one cable)</b>						
STF 12-1 Steel Fix	81661801	Hooped clamp	1	6.0 – 12.0	16.0	55.0
STF 14-1 Steel Fix	81661802	Hooped clamp	1	12.0 – 14.0	18.0	52.0
STF 16-1 Steel Fix	81661803	Hooped clamp	1	14.0 – 16.0	20.0	54.0
STF 18-1 Steel Fix	81661804	Hooped clamp	1	16.0 – 18.0	22.0	56.0
STF 20-1 Steel Fix	81661805	Hooped clamp	1	18.0 – 20.0	24.0	59.0

**STRAIN RELIEF WITH STEEL FIX**

Type	Order No.	Description	Seats qty.	Cable Ø mm	Width mm	Total height (H) mm
STF 22-1 Steel Fix	81661806	Hooped clamp	1	20.0 – 22.0	26.0	61.0
STF 26-1 Steel Fix	81661807	Hooped clamp	1	22.0 – 26.0	30.0	70.0
STF 30-1 Steel Fix	81661808	Hooped clamp	1	26.0 – 30.0	34.0	74.0
STF 34-1 Steel Fix	81661809	Hooped clamp	1	30.0 – 34.0	38.0	78.0
STF 38-1 Steel Fix	81661810	Hooped clamp	1	34.0 – 38.0	42.0	82.0
STF 42-1 Steel Fix	81661811	Hooped clamp	1	38.0 – 42.0	46.0	91.0
<b>Double clamp (for two cables)</b>						
STF 12-2 Steel Fix	81661821	Hooped clamp	2	6.0 – 12.0	16.0	73.0
STF 14-2 Steel Fix	81661822	Hooped clamp	2	12.0 – 14.0	18.0	74.0
STF 16-2 Steel Fix	81661823	Hooped clamp	2	14.0 – 16.0	20.0	82.0
STF 18-2 Steel Fix	81661824	Hooped clamp	2	16.0 – 18.0	22.0	86.0
STF 20-2 Steel Fix	81661825	Hooped clamp	2	18.0 – 20.0	24.0	91.0
STF 22-2 Steel Fix	81661826	Hooped clamp	2	20.0 – 22.0	26.0	95.0
STF 26-2 Steel Fix	81661827	Hooped clamp	2	22.0 – 26.0	30.0	108.0
STF 30-2 Steel Fix	81661828	Hooped clamp	2	26.0 – 30.0	34.0	121.0
STF 34-2 Steel Fix	81661829	Hooped clamp	2	30.0 – 34.0	38.0	129.0
<b>Triple clamp (for three cables)</b>						
STF 12-3 Steel Fix	81661841	Hooped clamp	3	6.0 – 12.0	16.0	98.0
STF 14-3 Steel Fix	81661842	Hooped clamp	3	12.0 – 14.0	18.0	98.0
STF 16-3 Steel Fix	81661843	Hooped clamp	3	14.0 – 16.0	20.0	105.0
STF 18-3 Steel Fix	81661844	Hooped clamp	3	16.0 – 18.0	22.0	111.0
STF 20-3 Steel Fix	81661845	Hooped clamp	3	18.0 – 20.0	24.0	118.0
STF 22-3 Steel Fix	81661846	Hooped clamp	3	20.0 – 22.0	26.0	130.0

**MP 52/62/72 LOCK BUTTON**

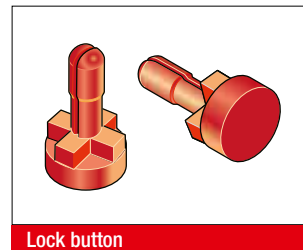
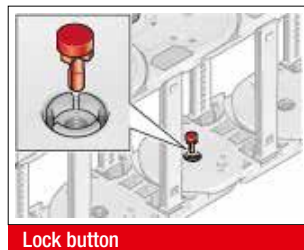
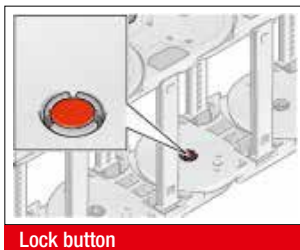

To increase the side stability, we recommend the use of lock buttons during strong lateral acceleration or when installed

“laying on the side (turned 90°) without support”.

Type	Order No.
MP52/62/72 lock button	0520000080

**MP 72 LOWERED FIXING POINT**

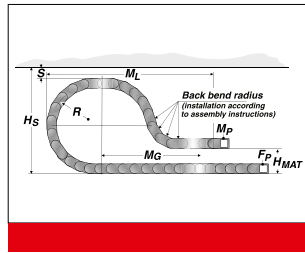
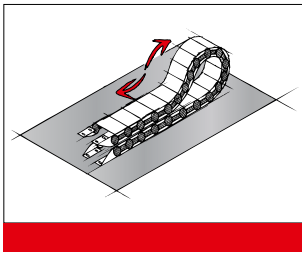

It is sometimes necessary to lower the height of the moving attachment point.

In such cases, modifications to the chain layout should be noted (e.g. extension of chain).

Please contact our application engineers.

Radius R mm	Height of moving end bracket (H <sub>MA</sub> ) mm	Safety margin (S) mm	Installation height incl. safety (H <sub>s</sub> ) mm	Projection (M <sub>1</sub> ) mm	Additional links qty.	of which additional back chain links qty.
200.0	240.0	60.0	580.0	850.0	9	2
250.0	260.0	60.0	680.0	1010.0	12	3
300.0	290.0	60.0	780.0	1150.0	13	3
400.0	350.0	60.0	980.0	1360.0	16	3
500.0	400.0	60.0	1180.0	1620.0	20	3

**MP 72 REARWARD RADII**

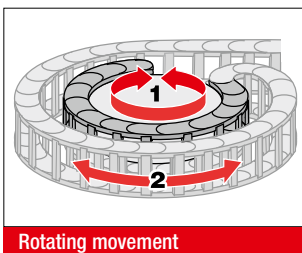

Rotating movement

Side links with rearward radius allow movements in both directions. This is intended for rotating movements and lowered chain brackets. Note: This type of chain has different chain links for the left or right side! Rotation movements are only possible with open variants.

Type	Order No.	Radius mm	Rearward radius mm
SR 72 (RÜ300/R300) left	072000030060	300.0	300.0
SR 72 (RÜ300/R300) right	072000030062	300.0	300.0

**GUIDE CHANNEL VAW (ALUMINIUM / STAINLESS STEEL)**



VAW steel galvanised / stainless steel



VAW aluminium

A range of variable guide channel systems, constructed from aluminium or stainless steel sections, are available for this energy chain.

The variable guide channel ensures that the energy chain is supported and guided securely.

**ASSEMBLY INSTRUCTION FLEXIBLE CHAIN BRACKET EB**

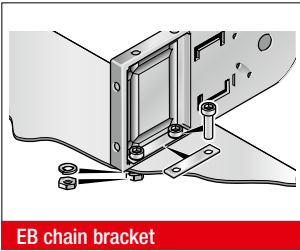

The flexible chain bracket is delivered with insert panels to prevent cold flow by the plastic.

**ASSEMBLY**

**DISASSEMBLY**

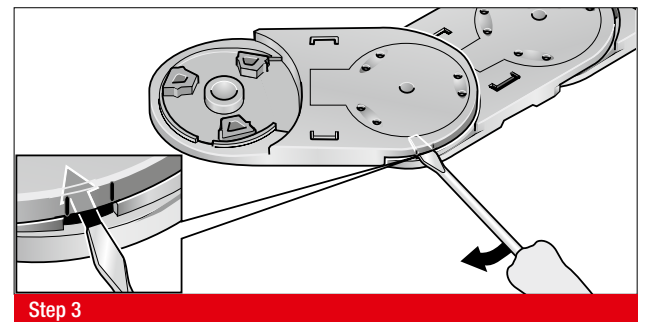
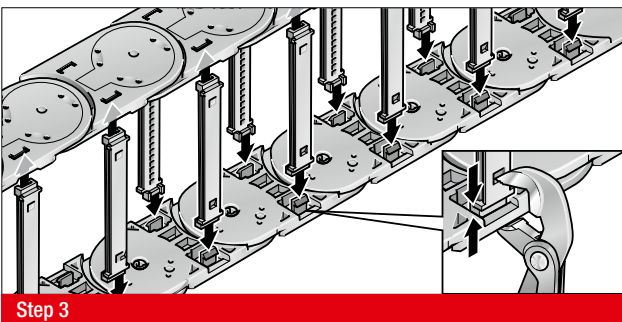
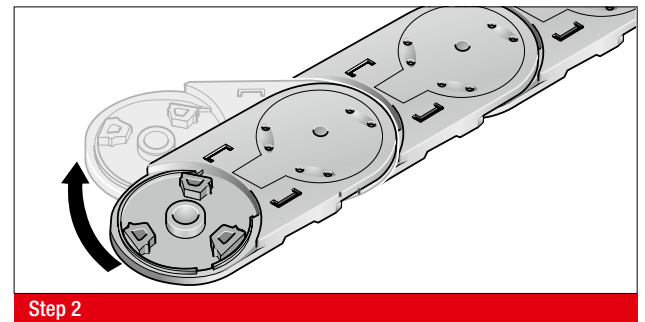
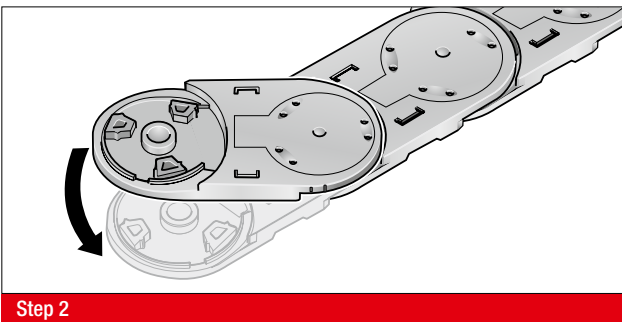
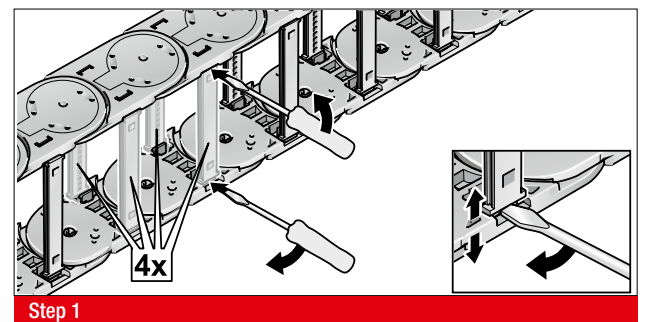
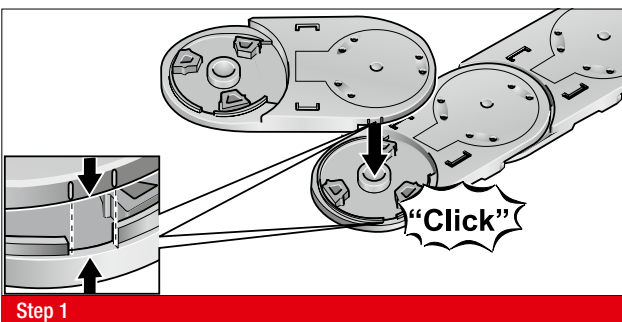





## Strain relief systems



## Introduction

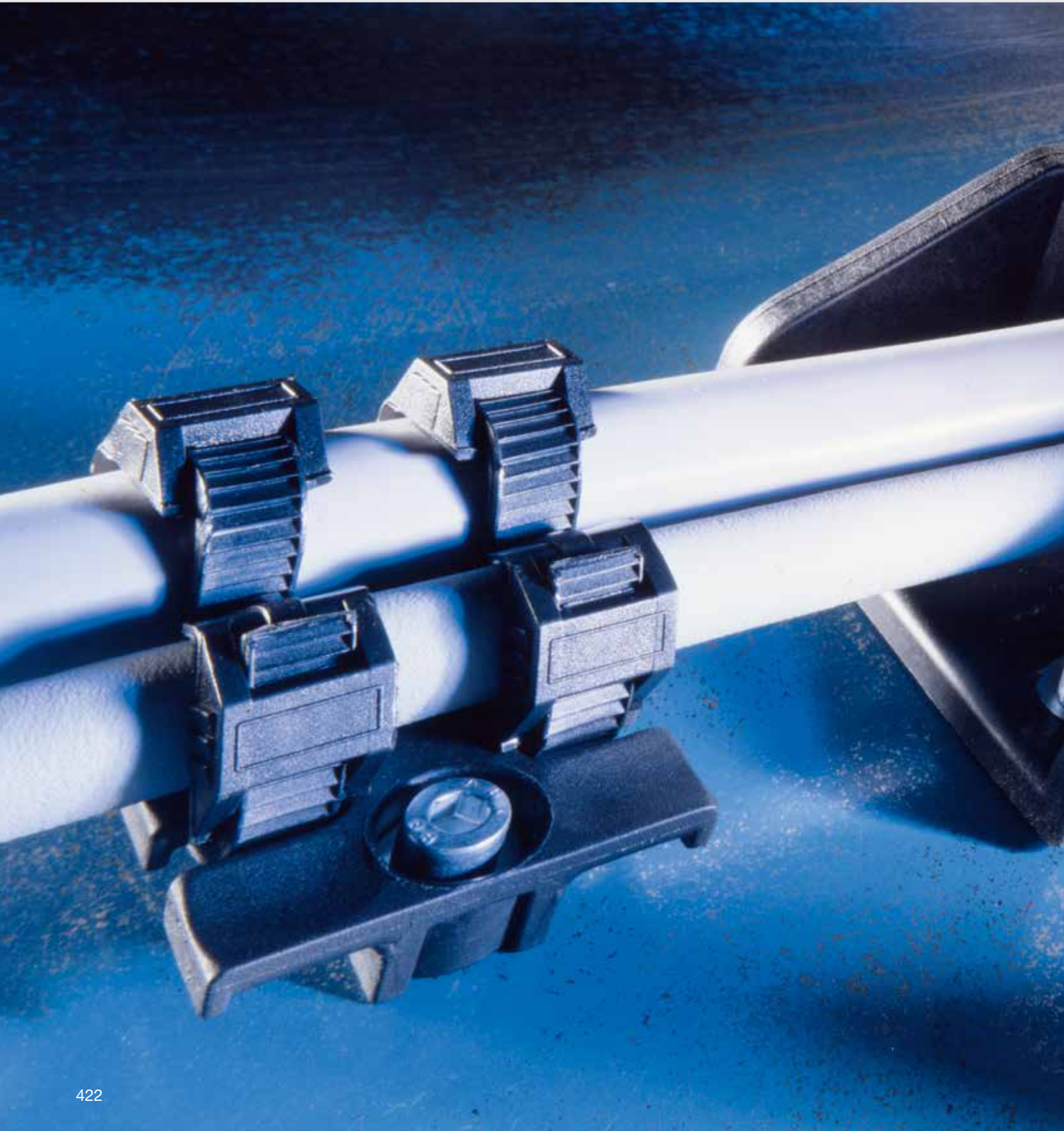



**For every system:**

**The right strain relief**

Cables and conduits that are to be routed in a cable drag chain should always be secured using a strain relief mechanism.

The right strain relief mechanism has a positive effect on the durability of the cables and conduits.

**ZL (strain relief plate)**

This strain relief mechanism offers a safe and cost-effective system using cable ties. The insertable bushing (ELB) stops the cold extrusion characteristic of plastic from affecting the secure fixing of the plate. The spacer sleeve (DH) enables a double-deck mounting option.

**RS-ZL (crossbar strain relief plate)**

The crossbar strain relief plate is snapped-in to the cable drag chain's chain brackets. Two RS-ZL units can be mounted on each of the two chain ends (on the inside and the outside bend). The cables are secured using cable ties.

**Steel Fix bow clamp**

A C-rail (slot width 11 mm), integrated into the chain bracket, serves to secure the Steel Fix bow clamps. The bow clamps can be used for strain relief of one, two or three cables arranged on top of each other. In the standard design, the housing body is protected against corrosion by cathodic dip painting. A stainless steel model is also available.

*Strain relief plate (ZL) mounted in a cable drag chain's chain bracket.*



## Benefits

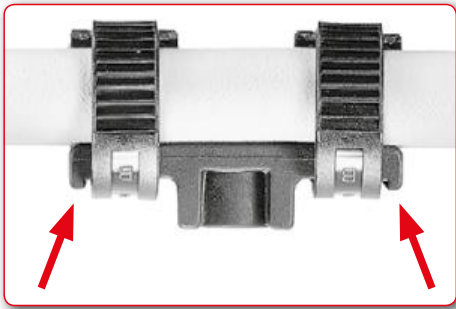

### Secure hold

The undercut on the underside of the plate prevents the cable tie from slipping off – even with very large cable diameters.

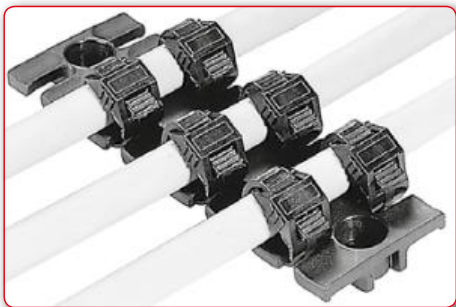

### Longer life

Each cable is secured by two power cable ties on each end. This spreads the pressure on the cable and thereby minimizes the risk of damage to the cable core.



### Wide support face on the individual plate tongues

The cables are optimally secured by the wide supporting surfaces of the individual strain relief tongues. The wide power cable ties help to facilitate strain relief which is quick and simple but gentle on the cables.

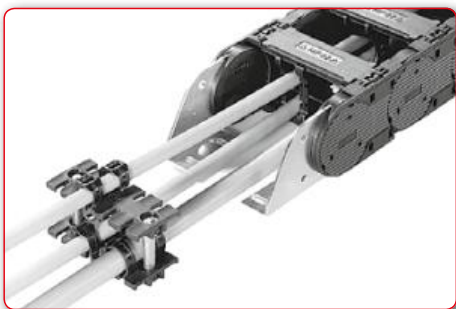

### Two-tier assembly

The DH spacer sleeves allow mounting one above the other.

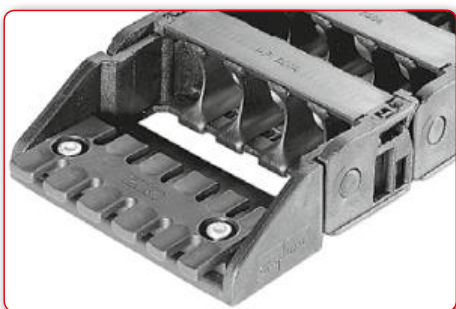

### Compatible fixing holes

The dimensions of the holes on the plates system match those on the chain brackets.

Please note the dimension of the holes on the strain relief plate when using strain relief in the chain bracket.



**Durable fastening with metal bushing.**

The metal bushings inhibit cold flow properties. Metal is screwed onto metal. The screws are prevented from working loose. (Please order separately.)

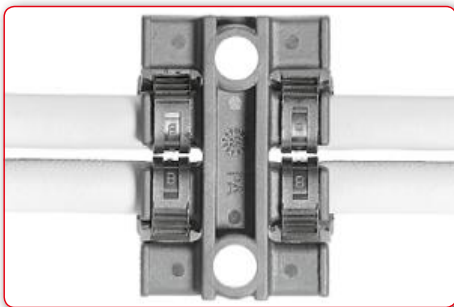

**Easy assembly**

Even if two cables are immediately next to each other, it is possible to secure them with two power cable ties.



**Different cable diameters**

The flexible use of power cable ties provides strain relief which is quick and simple but very gentle on the cables, even for cables of very different diameters with extremely high packing density.

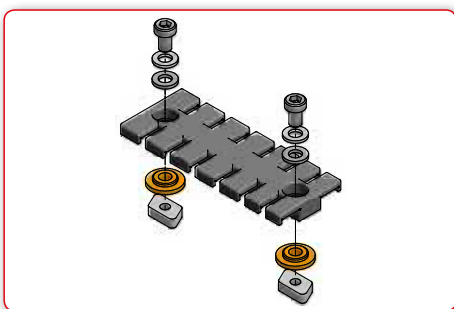

**Single or as a complete set**

Our strain relief plates are available singly or in a set, e.g. for mounting on a C-rail:

A strain relief plate, complete with cylinder head bolt, plain and serrated washer, insert bushings and T-slot nut.

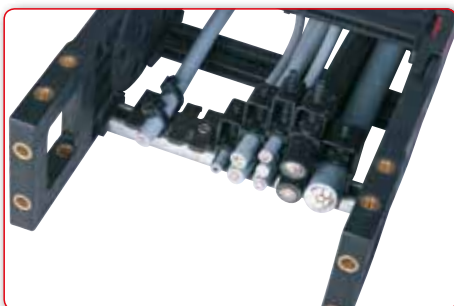

**Steel Fix bow clamps**

- for C-rails with a groove width of 11 mm
- for one, two or three cables on top of each other
- Corrosion protection via cathodic dip painting (CDP)
- Trough elements with low-wear cable design
- Stainless steel design available on request

## Selection criteria / engineering notes

### Where is the strain relief made?

For cable drag chains with standard inside widths of up to 243 mm, crossbar strain relief plates (RS-ZL) are the ideal solution for relieving power cabling and media conduits from strain in a space-saving, secure way. They are supplied in the same widths as the crossbars for the respective chain type.

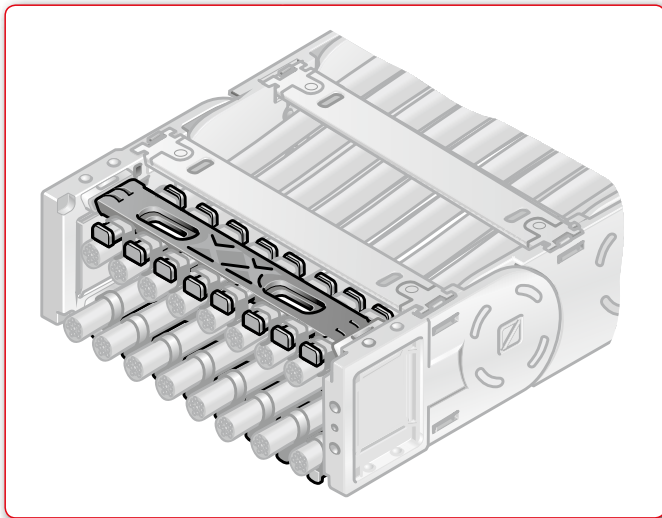

They are secured in much the same way as the crossbars themselves, by snapping them into pre-cut recesses in the chain brackets. This enables two strain relief plates to be integrated into the cable drag chain per cable end, both for the inside bend and the outside bend.

As an alternative, the same recesses that accept a crossbar strain relief plate can also be used for the fixed integration of a C-rail. This enables the

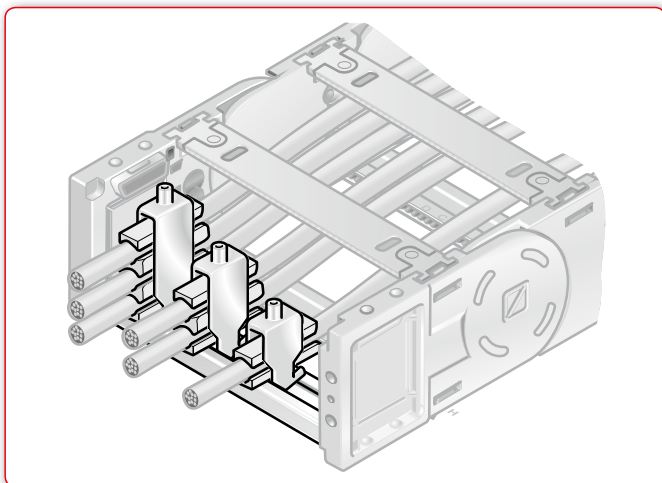

provision of rapid and reliable strain relief even for individual chain inside widths that differ from the grid spacings.

We offer two separate strain relief systems for this specific application:

The first is to use our Steel Fix bow clamps, which accept up to three power cables on top of one another per fixing element. The second option is ZL-format strain relief plates, which match crossbar strain relief plates in form and function.

The options described above assume that the distance from the last movable point of the cable drag chain to the strain relief mechanism is sufficient for all of the installed power cabling/media conduits (depends on the minimum bending radius).

If this is not the case, then you will need to use one of the options as described below:

### 1. Reposition strain relief in front of chain

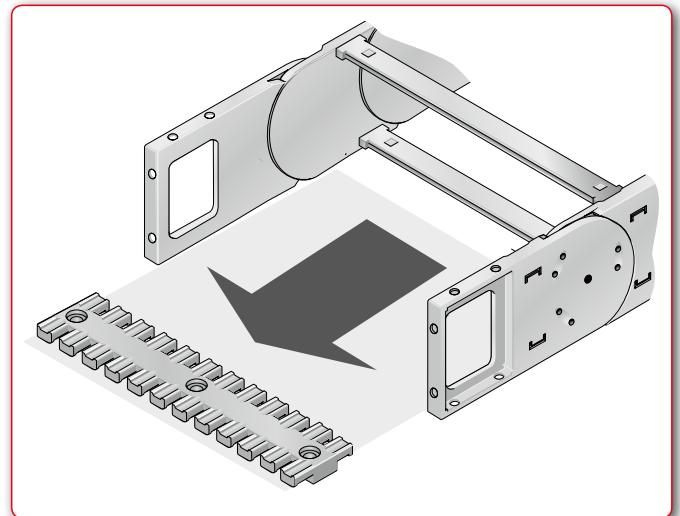

To increase the distance from the strain relief to the first movable point, the strain relief can be moved to a position outside the chain bracket. To do so, you can utilise our Steel Fix bow clamps and ZL-C strain relief plates, which are mounted on C-rails. The ZL strain relief plates can also be secured to a load-bearing substrate directly, without using C-rails.

A further positive effect of this option is that the chain bracket itself remains free of additional pulling forces.

## Design / structure

### 2. Lengthening the chain

If the installation space available permits and the circular arc distance may be increased still further, then the installation of additional chain links can also be used to achieve the necessary distance between the strain relief and the first movable point of the chain.

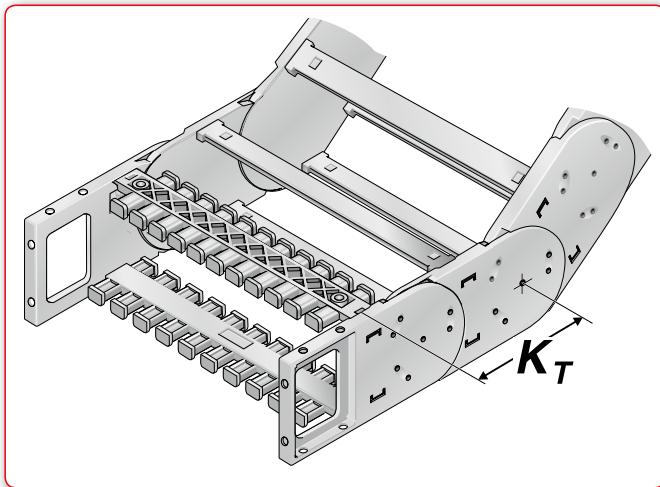

**Note on installation width when using a permanently installed C-rail.**

To secure a C-rail within the chain bracket (order no.: 81661610), one fixing clip is inserted into the C-rail on both sides. This slightly reduces the installation space available for strain relief plates or for bow clamps. The space required for the mounting clip depends on the chain type deployed and is in the range 4–15 mm. Please contact our layout experts.

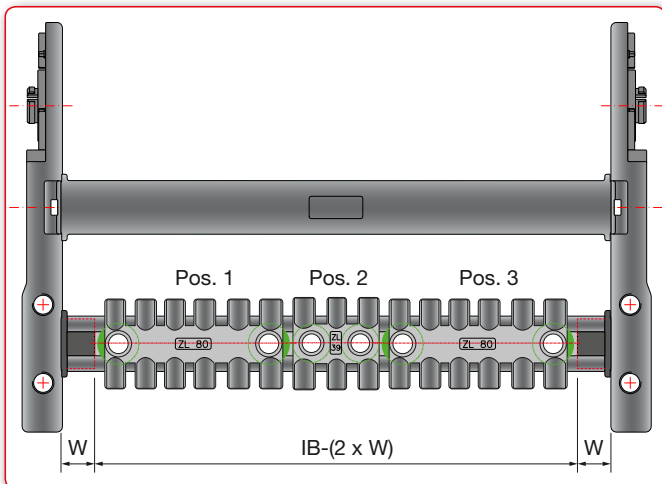

### Solutions for inside widths over 243 mm

For our *HeavyLine* and *PowerLine* chains, the RS-ZL strain relief plate offers standard solutions up to an inside width of 243 mm. For larger inside widths, multiple strain relief plates are combined together and mounted on a C-rail (order no.: 81661610). We recommend the following solutions:

Inside width in mm			Recommended ZL combinations			
Nominal	-2xW	Effective	Item 1	Item 2	Item 3	Item 4
246	30	216	ZL 87	ZL 39	ZL 87	
252	30	222	ZL 39	ZL 121	ZL 60	
256	30	226	ZL 87	ZL 140		
258	30	228	ZL 87	ZL 140		
268	30	238	ZL 60	ZL 87	ZL 87	
293	30	263	ZL 87	ZL 87	ZL 87	
296	30	266	ZL 87	ZL 180		
318	30	288	ZL 60	ZL 87	ZL 140	
343	30	313	ZL 87	ZL 103	ZL 121	
346	30	316	ZL 87	ZL 87	ZL 140	
350	30	320	ZL 180	ZL 140		
358	30	328	ZL 121	ZL 103	ZL 103	
368	30	338	ZL 80	ZL 80	ZL 180	
371	30	341	ZL 140	ZL 121	ZL 39	ZL 39
396	30	366	ZL 121	ZL 103	ZL 140	
418	30	388	ZL 87	ZL 121	ZL 180	
421	30	391	ZL 140	ZL 121	ZL 87	ZL 39
446	30	416	ZL 87	ZL 121	ZL 121	ZL 87
468	30	438	ZL 87	ZL 87	ZL 87	ZL 180
496	30	466	ZL 121	ZL 121	ZL 103	ZL 121
518	30	488	ZL 87	ZL 103	ZL 121	ZL 180
546	30	516	ZL 39	ZL 121	ZL 180	ZL 180

### How is the strain relief applied?

The strain relief itself should be fitted with two power cable ties on each side of the cable and secured approx. 20 to 30 x cable diameters away from the last moving chain link.

The strain relief is suitable for cables up to approx. 40 mm in diameter.

All electric cables must be relieved of strain at both the moving and fixed end. For longer travel distances (and gliding applications), strain relief on one side at the moving end is recommended. Care must be taken to ensure pressure on the power cabling is applied broadly across its outer jacket.

## Strain relief plate, type ZL-C set and ZL

The ZL-C set and ZL type strain relief plates are used for strain relief when laying various different cables on machines and installations. When used in cable drag chains, the cables are secured to the strain relief plates on both sides of the chain with type KB 28 power cable ties (order no.: 87661258).

The undercut on the strain relief plates prevent the power cable ties from slipping off, even when the routed cable diameter is itself larger than the plate tongue. Every cable is clamped twice at each end with cable ties.

The actual strain relief is accomplished using cable ties. We recommend using our own type KB power cable ties. These are equipped with a special locking mechanism and are especially suitable for heavy-duty applications. Wide, highly flexible power cable ties increase the surface pressure and ensure longer service life.

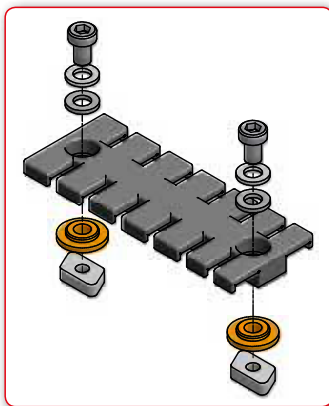

### ZL-C set

In addition to a type ZL strain relief plate, the ZL-C sets contain a complete set of installation materials, such as washers, serrated and spacer washers, plus T-slot nuts for installation in the C-rail.

Type	ZL-C 39 set	Type	ZL 39
Order no.	87702810	Order no.	87701014
A = 38.5 mm	X = 9.0 mm		
B = 40.0 mm	Y = 9.0 mm		
C = 19.5 mm			
D = 12.0 mm	G = 10.0 mm		
E = 9.0 mm	H = 3.1 mm		
F = 14 mm			

Type	ZL-C 60 set	Type	ZL 60
Order no.	87702812	Order no.	87701016
A = 59.5 mm	X = 9.0 mm		
B = 40.0 mm	Y = 7.0 mm		
C = 43.5 mm	Z = 61.5 mm		
D = 12.0 mm	G = 10.0 mm		
E = 9.0 mm	H = 3.1 mm		
F = 14 mm			

Type	ZL-C 80 set	Type	ZL 80
Order no.	87702814	Order no.	87701015
A = 79.5 mm	X = 5.7 mm		
B = 40.0 mm	Y = 5.7 mm		
C = 68.0 mm	Z = 86.0 mm		
D = 12.0 mm	G = 10.0 mm		
E = 9.0 mm	H = 3.1 mm		
F = 14 mm			

Type	ZL-C 87 set	Type	ZL 87
Order no.	87702816	Order no.	87701018
A = 86.5 mm	X = 9.0 mm		
B = 40.0 mm	Y = 9.5 mm		
C = 68.5 mm			
D = 12.0 mm	G = 10.0 mm		
E = 9.0 mm	H = 3.1 mm		
F = 14 mm			

Type	ZL-C 103 set	Type	ZL 103
Order no.	87702818	Order no.	87701020
A = 102.5 mm	X = 9.0 mm	D = 12.0 mm	G = 10.0 mm
B = 40.0 mm	Y = 9.5 mm	E = 9.0 mm	H = 3.1 mm
C = 19.5 mm		F = 14 mm	

Legend for dimensions	Cross-section
Z = Installation width = C+X+Y	
A = Length	
B = Width	
C = Hole spacing	
X = Hole spacing to edge	
Y = Hole spacing to edge	
Z = Installation width	
D = Inside diameter (above)	
E = Inside diameter (below)	
F = Outside diameter (below)	
G = Assembly height	
H = Material thickness	



## Strain relief plate, type ZL / two-tier strain relief plate

Type	ZL-C 121 set	Type	ZL 121
Order no.	87702820	Order no.	87701022
A = 121.0 mm	X = 9.0 mm	D = 12.0 mm	G = 10.0 mm
B = 40.0 mm	Y = 9.5 mm	E = 9.0 mm	H = 3.1 mm
C = 102.5 mm		F = 14 mm	

Type	ZL-C 140 set	Type	ZL 140
Order no.	87702822	Order no.	87701024
A = 139.5 mm	X = 9.0 mm	D = 12.0 mm	G = 10.0 mm
B = 40.0 mm	Y = 9.5 mm	E = 9.0 mm	H = 3.1 mm
C = 121.5 mm		F = 14 mm	

Type	ZL-Cset 180/6	Type	ZL 180/6
Order no.	87702824	Order no.	87701026
A = 177.9 mm	X = 9.0-11.7	D = 12.0 mm	G = 11.5 mm
B = 42.0 mm	Y = 9.0-11.7	E = 9.0 mm	H = 3.2 mm
C = 154.5-160 mm		F = 16 mm	

Type	Not a set	Type	ZL 180/8
Order no.	--	Order no.	87701027
A = 177.9 mm	X = 9.0-11.7	D = 13.5 mm	G = 11.5 mm
B = 42.0 mm	Y = 9.0-11.7	E = 11.0 mm	H = 3.2 mm
C = 154.5-160 mm		F = 16 mm	

### Two-tier installation

When deploying a shelving system and to achieve highed packing densities, you can also install two strain relief plates above each other. The necessary distance between the levels is ensured by using spacer sleeves type DH.

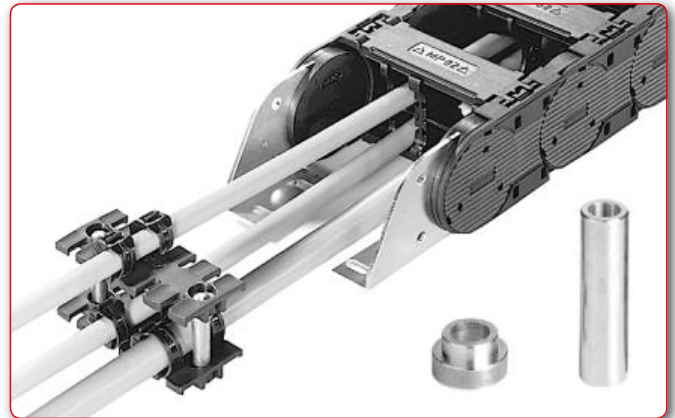

Type	ELB/6
Order no.	87701050
A = 6.5 / B = 12.0 / C = 6.2	

Type	ELB/8
Order no.	87701060
A = 6.5 / B = 13.4 / C = 8.2	

*Dimensions in mm*

Type	DH 32/6
Order no.	87701052
A = 32.0 / B = 12.0 / C = 6.3	

Type	DH 32/8
Order no.	87701062
A = 32.0 / B = 13.0 / C = 8.3	

*Dimensions in mm*

## Steel Fix bow clamp

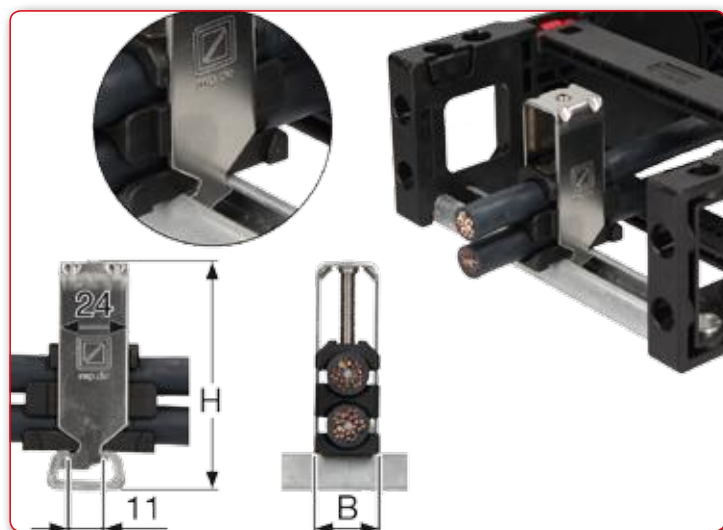

A permanently integrated C-rail (dip galvanised, order no. 81661610) for accommodating the Steel Fix bow clamps in the chain brackets.

The bow clamps can take up to 3 cables and are suitable for C-rails with a slot width of 11 mm. Due to the design of the trough elements, a cable preserving cable guidance is ensured. Adjusted to all chain inside widths up to 200 mm in size. May be assembled on the inside and outside bends at both chain endings.

A stainless steel model is also available.

The overall height stated is a guide only. The actual height is, amongst other things, dependent on the diameter and the quality of the cable. A safety distance of 10 mm at the fixed point above the strain relief must be kept during gliding applications.

Type	Order no.	Cable Ø	Width (B)	Height (H)*	Pitch (T)
<b>Single bow clamp (for 1 cable)</b>					
STF 12-1 Steel Fix	81661801	6 – 12	16	55	24
STF 14-1 Steel Fix	81661802	12 – 14	18	52	24
STF 16-1 Steel Fix	81661803	14 – 16	20	54	24
STF 18-1 Steel Fix	81661804	16 – 18	22	56	24
STF 20-1 Steel Fix	81661805	18 – 20	24	59	24
STF 22-1 Steel Fix	81661806	20 – 22	26	61	24
STF 26-1 Steel Fix	81661807	22 – 26	30	70	24
STF 30-1 Steel Fix	81661808	26 – 30	34	74	24
STF 34-1 Steel Fix	81661809	30 – 34	38	78	24
STF 38-1 Steel Fix	81661810	34 – 38	42	82	24
STF 42-1 Steel Fix	81661811	38 – 42	46	91	24
<b>Double bow clamp (for 2 cables)</b>					
STF 12-2 Steel Fix	81661821	6 – 12	16	73	24
STF 14-2 Steel Fix	81661822	12 – 14	18	74	24
STF 16-2 Steel Fix	81661823	14 – 16	20	82	24
STF 18-2 Steel Fix	81661824	16 – 18	22	86	24
STF 20-2 Steel Fix	81661825	18 – 20	24	91	24
STF 22-2 Steel Fix	81661826	20 – 22	26	95	24
STF 26-2 Steel Fix	81661827	22 – 26	30	108	24
STF 30-2 Steel Fix	81661828	26 – 30	34	121	24
STF 34-2 Steel Fix	81661829	30 – 34	38	129	24
<b>Triple bow clamp (for 3 cables)</b>					
STF 12-3 Steel Fix	81661841	6 – 12	16	98	24
STF 14-3 Steel Fix	81661842	12 – 14	18	98	24
STF 16-3 Steel Fix	81661843	14 – 16	20	105	24
STF 18-3 Steel Fix	81661844	16 – 18	22	111	24
STF 20-3 Steel Fix	81661845	18 – 20	24	118	24
STF 22-3 Steel Fix	81661846	20 – 22	26	130	24

\* Total height with max. cable diameter, including C-rail



## Appendix















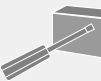

## Protection classes EN 60529

An important element for housings is protection of integrated elements against drilling, foreign particles and water. The various protection properties are divided into IP classes (IP = international protection). The framework conditions that a protection class must guarantee are laid out in DIN 40050 and IEC-EN 60529.

IP protection classes are indicated through a two digit code (IPXX). The first digit indicates protection against contact and foreign particles, the second the water protection factor.

Accordingly the class IP65 is completely protected against contacts, dustproof (1st digit = 6) and is protected against jets of water from a nozzle in all directions (2nd digit = 5).

First index number	Contact protection	Foreign particle protection	Second index number	Brief description	Water protection
0	No protection		0	No protection	
1	Protected against solid foreign objects of 50 mm and larger	The object probe, a sphere of 50 mm in diameter, must not fully penetrate. 	1	Protected against vertical falling drops of water	Drops which fall vertically must not have any harmful effect. 
2	Protected against solid foreign substances of 12.5 mm dia. and above.	The object probe, a sphere of 12.5 mm in diameter, must not fully penetrate. 	2	Protected against diagonally falling (up to 15°) drops of water	Drops which fall vertically must not have any harmful effects if the housing is inclined at an angle of up to 15° at either side of the perpendicular. 
3	Protected against solid foreign substances of 2.5 mm dia. and above.	The object probe of diameter 2.5 mm must not penetrate at all. 	3	Protected against diagonally falling spray (up to 60°)	Water which is sprayed at an angle of up to 60° from either side of the perpendicular must not have any harmful effects. 
4	Protected against solid foreign substances of 1.0 mm dia. and above.	The object probe of diameter 1.0 mm must not penetrate at all. 	4	Protected against spray from all directions	Water splashing against the enclosure from one direction shall have no harmful effect. 
5	Dust-protected	The ingress of dust is not fully prevented; however, it must not penetrate to such an extent that satisfactory operation or safety are impaired. 	5	Protected against jets of water (nozzle)	Water which is sprayed in a jet against the housing from any direction must not have any harmful effects. 
6	Dust-tight	No ingress of dust. 	6	Protected against strong water jets (flooding)	Water projected in powerful jets from any direction against the housing shall have no harmful effects. 
			7	Protected against the effect of temporary submersion in water	Water must not penetrate to an extent that will cause harmful effects, if the housing is temporarily submerged in water, under pressure and under time conditions. 
			8	Protected against the effect of permanent immersion in water	Water must not penetrate to such an extent that it will cause harmful effects if the housing is permanently submerged in water. 
			9k	Protection against highly pressurised water/steam jet cleaning	IP x9K according to DIN 40050 Water jet at 0°, 30°, 60° and 90° Cycle: 30 seconds each Distance: 10 - 15 cm Water volume: 14 - 16 litres per min. Water temperature: 80 °C +/- 5 °C Water pressure: 80-100 bar 

## Description of fire classifications according to UL 94



### Fire classification HB

The material burns slowly in the horizontal combustion test. The rate of combustion must not exceed 3 inch/min. for wall thicknesses of up to 3 mm, and 1.5 inches/min. for wall thicknesses over 3 mm. Any materials exceeding these combustion rate limits are not registered by UL.



### Fire classification V2

In the vertical combustion test, self-extinguishing must occur after an average of 25 seconds (individual values not to exceed 30 seconds). Any dripping material may ignite cotton wool located underneath. However, any afterglow must not exceed 60 seconds.



### Fire classification V1

In the vertical combustion test, self-extinguishing must also occur after an average of 25 seconds (individual values not to exceed 30 seconds). However, any possible dripping material must not ignite the cotton wool. Any afterglow must not exceed 30 seconds.



### Fire classification V0

In the vertical combustion test, self-extinguishing must occur after an average of less than 5 seconds (individual values not to exceed 10 seconds). Any material dropping off must not ignite cotton wool placed underneath and any afterglow must not exceed 30 seconds.

## Description of fire classifications according to DIN 5510



### Combustion class S4

Test procedure: acc. to DIN 54837

Requirements:

- Length of the destroyed area:  $\leq 20$  cm
- No afterburning

Products may also be assigned to combustion class S4 if afterburning occurs within the burnt testing area and the average duration of afterburning does not exceed 10 seconds. If afterburning occurs in the undamaged area

of the test piece, the product must not be assigned to combustion class S4.

Products must not be assigned to combustion class S4 if an afterburning time of more than 120 seconds is observed for a test specimen.

## Material characteristics



### Burning behaviour

The flame-retardant properties of Murrplastik cable drag chains meet various classifications:

Test procedures acc. to VDE 0304 Parts 3/5.70

Classification: IIc

Testing based on "UL 94 – Standard Tests for Flammability of Plastic Materials for Parts in Devices and Appliances"

Classification: 94 HB with a 3.2 and 1.6 mm body thickness

Tested acc. to DIN 4102 "Fire behaviour of building materials and elements"

Classification: Materials class B 2

In case of more stringent applications please contact us.



### Radiation resistance

Murrplastik cable drag chains are very resistant to high-energy radiation. In the range of  $8 \times 10^6$  Gy gamma radiation, the mechanical properties change very little.

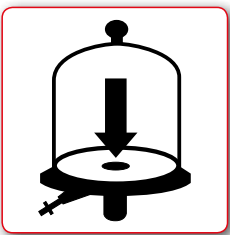

### Vacuum

Murrplastik plastic cable drag chains may be safely used in a vacuum. Gas will only be given off in very low amounts.

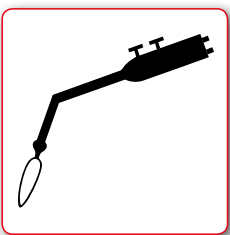

### Welding flashes and hot sparks

For cables on robotic welding machines, Murrplastik cable drag chains offer the best line protection possible. This has been demonstrated both in laboratory testing and numerous references. The material may appear optically impaired but in no way will its function be reduced. Murrplastik cable drag chains have successfully passed tests involving medium-sized hot metal swarf at 500 °C.



### Use in EX explosion proof areas

The Murrplastik cable drag chain may be used in explosion proof areas if manufactured to specification with a special material and if the standard regulations are observed. All Murrplastik cable drag chains are certified in accordance with ATEX European Directive 94/9 EC and can therefore be used in the relevant areas without hesitation.



### Weatherproof

Murrplastik cable drag chains are suitable for outdoor applications. Experience has shown that the mechanical properties are not impaired.



### Use in clean rooms

Murrplastik uses a special material. This reduces even further the very low wear of a normal chain. In many applications in which difficult special conditions apply, the cable drag chain can still be used. An intensive test program can be set up to verify its suitability in self-supporting and gliding applications.

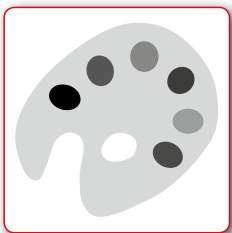

### Special colours

Cable drag chains can be supplied in colours other than black on request. Several colours can also be combined where colour-psychological effects are desired. Minimum order quantities and special prices apply.



### Use in cold storage

A special material is used for cold storage resistant cable drag chains.

## Parts made of plastic / standard material



Murrplastik cable drag chains have been developed for use in extreme conditions. The standard material is glass fibre reinforced plastic in standard black.

### Properties

The PA (polyamide) we have developed meets stringent requirements for high mechanical capability regarding strain, pressure, torsion and free running. For specific, problematic scenarios (e.g. clean-room applications, specific climatic requirements, deployment in hygienically demanding environments), we draw on our long-standing experience to offer modified materials and can hence offer a solution to match almost any scenario.

The cable drag chain plastic is free of halogens, silicones and hard metals such as lead and cadmium. No formaldehydes are used in manufacturing.

Mechanical properties		Test	Test value	Unit
Tensile strength (DIN 53 455)		dry	190	N/mm <sup>2</sup>
		humidity	120	N/mm <sup>2</sup>
Crack resistance (DIN 53 455)		dry	4	%
		humidity	6	%
Elasticity module	Tensile test	dry	7000	N/mm <sup>2</sup>
		humidity	10000	N/mm <sup>2</sup>
Impact resistance (DIN 53 455)	23 °C	dry	60	kJ/m <sup>2</sup>
	23 °C	humidity	75	kJ/m <sup>2</sup>
	-40 °C	dry	50	kJ/m <sup>2</sup>
Creep module E	23 ... 50 °C	humidity	5400	N/mm <sup>2</sup>
	120 °C	dry	2100	N/mm <sup>2</sup>
Heat conductivity			0.3	W/k x m
Static electricity value (DIN 53 455)		dry	3.8	MHz
		humidity	6.8	MHz
Special volume resistance		dry	10 <sup>15</sup>	Ω x cm
		humidity	10 <sup>12</sup>	Ω x cm
Impact resistance	Thickness 0.6 ... 0.8 mm		80	kV/mm
Surface resistance ROA		dry	10 <sup>12</sup>	Ω
		humidity	10 <sup>10</sup>	Ω
Moisture absorption	23 ... 25 °C		1.8±0.2	%
<b>Temperature limits</b>				
permissible temperature -30 ... 100 °C				
5000 hours up to 135 °C				
several hours up to 170 °C				
<b>Other properties</b>				
Density	dry		1.4 g/cm <sup>3</sup>	
Coefficient of sliding friction	unlubricated		0.3–0.45	
Combustion profile	DIN VDE 0304 Part 3			
Fire classification acc. to UL	HB			



## Parts made of metal / standard material

The advantage of using light metal for certain parts lies in the combination of its mechanical strength, resistance to chemical attack and its physical properties.



Murrplastik use a special aluminium alloy with the following properties. It stands out due to the following characteristics:

- Light, stable, hard and smooth
- Visually appealing
- Very low friction and wear profile for this light metal against cabling materials
- No tendency to become brittle at low temperatures
- Brine-resistant

Aluminium is used by Murrplastik for the following products: Cross member profiles and profiles for variable guide channel system VAW.

## Directives: What's meant by these abbreviations?

The use of specific materials in vehicles, as in electric and electronic devices, is restricted and/or forbidden by a set of European directives. Various associations and fabricators have published their own lists of materials considered undesirable.

**RoHS-Directive 2002/95/EG** (RoHS = Restriction of the use of certain Hazardous Substances in electrical and electronic equipment)

The guidelines limiting specific hazardous materials in electric and electronic devices categorised the following materials and their compounds as dangerous: lead, mercury, cadmium, chrome 6, polybrominated biphenyl (PBB) and polybrominated diphenyl ether (PBDE).

**VDA Lists** (VDA = Verband der Automobilindustrie in Deutschland, German Automotive Industry Association)

Alongside the legal stipulations, there are also a variety of material and declaration lists prescribed by various associations and fabricators. They contain materials and material groups that are undesirable or forbidden from the corresponding process-

ing branch for a variety of reasons. Several of the most well-known lists are shown in the following, their content drawn from other sources and in some cases expanded: VDA list 232-101 for notifiable materials; Bosch Standard N 2580. The VDA list is part of the ILRS list ("List for materials in automobile manufacture requiring declaration--substances in components and raw materials") that is used in the IMDS (International Material Data System).

**ELV Directive 2000/53/EC**  
(ELV = End-of-Life Vehicles)

The heavy metals listed in the ordinance (ELV) are a portion of those named in the RoHS guidelines, including lead, mercury, cadmium, chrome 6.

**WEEE Directive 2002/96/EC** (WEEE = Waste from Electric and Electronic Equipment)

Goal of the guidelines is the avoidance of waste from electric and electronic devices, as well as their recovery and recycling. They require selective handling of used devices with specific critical materials, as named in the guideline appendices.

## Chemical resistance of plastics

Reagent	Concentration %	At + °C	Polyethylene PE	Polyamide PA6	Polyamide PA 12	Polypropylene PP	Polyurethane PU
Acetaldehyde	100	20	+	40% o	+		+
Acetic acid	10	20	+	o	o	+	o
Acetone	100	20	+	+	+	+	-
Allyl alcohol	96	20		30% o	o	+	-
Alum, aqueous	diluted	40			+	+	
Aluminium chloride, aqueous	diluted	40	+		+	+	+
Aluminium sulphate, aqueous	diluted	40	+			+	+
Ammonia, aqueous	any	20	+	20% +		+	o
Ammonium chloride, aqueous	any	60	+		o	+	+
Ammonium nitrate, aqueous	diluted	40	+			+	+
Ammonium sulphate, aqueous	diluted	40	+			+	+
Aniline chlorohydrate, aqueous	saturated	20					
Aniline, pure	100	20	+	o	o	+	-
Benzaldehyde, aqueous	0.3	20	-	pure o	o	+	
Benzene	100	20	-	+	+	o	+
Benzoic acid	any	40	+		o	+	+
Benzol	100	20	-	+	+	o	-
Bleaching lye	12.5 Cl	20		-	o	o	
Boracic acid, aqueous	diluted	40	+	o	+	+	-
Borax, aqueous	diluted	40		o	+	+	
Boron	50	40		o			
Bromine, liquid	100	20	-	-	o	-	-
Butane diol	10	20		pure +		+	o
Butanol	100	20				+	+
Butyl acetate	100	20				o	-
Butyl alcohol	100	20	-			+	o
Calcium chloride, aqueous	any	40	+	+	o	+	+
Calcium nitrate, aqueous	50	40	+			+	+
Carbon bisulphide	100	20	-	o	+	+	+
Carbon dioxide	100	60	+			+	+
Carbon oxide	100	60	+			+	+
Carbon tetrachloride	100	20		+	o	o	+
Caustic potash solution	50	20		50% +		+	o
Chlorine	any	20	-	-	-	-	-
Chromic alum, aqueous	diluted	40				+	
Citric acid	10	40	+			+	o
Copper chloride, aqueous	saturated	20	+			+	+
Copper sulphate, aqueous	any	40	+			+	+
Cresol, aqueous	90	20	-	pure -	-	+	-
Crystallisable acetic acid	100	20			o	+	
Cyclohexanol	100	20		+		+	-
Ethyl acrylate/acrylic resin lacquer	100	20	-	30% -	-		
Ethyl alcohol, aqueous	10	20		o		+	+
Ethyl ether	100	20		30% +		o	-
Ethylene chloride	100	20				o	-
Ethylene oxide, liquid	100	20					
Exhaust gases containing carbon dioxide	any	60				+	+
Exhaust gases containing carbon oxide	any	60				+	+
Fluorine	50	40		-			
Formaldehyde, aqueous	diluted	40	+	pure +	o	+	o
Formic acid, aqueous	100	20		10% o	-	+	-

The information provided above enables an initial choice to be made. However, it is not intended as a guarantee of particular properties of the products or their suitability for a particular application. It does not release the buyer from the duty of carrying out suitability checks.

Reagent	Concentration %	At + °C	Polyethylene PE	Polyamide PA6	Polyamide PA 12	Polypropylene PP	Polyurethane PU
Glucose, aqueous	any	20	+			+	+
Hydrobromic acid, aqueous	10	40	+	-		+	-
Hydrochloric acid	10	30-40					
Hydrochloric acid, aqueous	10	20	+	20% -	o	+	-
Hydrogen	100	60		+			+
Hydrosilicofluoric acid	30	20	-				
Hydroxylamine sulphate, aqueous	12	35					+
Iron chloride, aqueous	10	40	+	o	+	+	+
Lactic acid, aqueous	50	20	o	pure +	o	+	o
Magnesium carbonate	any	20					+
Magnesium chloride, aqueous	any	20	+	10% o		+	+
Mercury		60	+	+	+	+	+
Methyl alcohol	100	20	+			+	o
Methyl chloride	100	20					
Methylene chloride	100	20		o	o	-	-
Nickel chloride, aqueous	any	20		10% o		+	+
Nickel sulphate, aqueous	any	20	+	10% o		+	+
Nitric acid, aqueous	6	20	+	50% -	-	+	-
Nitroglycerine	diluted	20					
Oils and greases		20	o	+	+	+	+
Oleic acid	100	20		+		+	o
Oxalic acid	saturated	20	+	10% o		+	o
Ozone	100	20	o	o	+	o	o
Petroleum							+
Phosgene, liquid	100	20					-
Phosphoric acid, aqueous	diluted	20	+	10% -	o	+	o
Phosphorus pentoxide	100	20				+	
Photographic developer		40				+	
Potash, aqueous	saturated	40			+		+
Potassium bromide, aqueous	any	60	+	10% +		+	o
Potassium chloride, aqueous	any	20	+	10% +		+	+
Potassium dichromate, aqueous	40	20				+	+
Potassium ferrocyanide, aqueous	any	60	o			+	
Potassium nitrate	any	20	+	10% +	+	+	+
Potassium permanganate, aqueous	6	20	+		o	+	-
Potassium persulphate, aqueous	diluted	40	-		+	+	+
Salt solution	any	40			+	+	+
Seawater		40	+	+	o	+	+
Soap solution, aqueous	concentrated	20		o		+	+
Soda lye, aqueous	10	20	+	+	+	+	o
Sodium chlorate, aqueous	any	20	+	10% o		+	
Sodium sulphide, aqueous	diluted	40				+	
Sulphuric acid	10	20	+	40-80% -	o	+	+
Tin chloride, aqueous	diluted	40			+	+	+
Toluene	100	20	-	+	+	o	+
Trichloroethylene	100	20	-	o		o	-
Urea, aqueous	10	40		20% +		+	+
Vinyl acetate	100	20					-
Xylene	100	20		+	+	o	+
Zinc chloride, aqueous	diluted	60	+	10% o	o	+	+
Zinc sulphate, aqueous	diluted	60	+			+	+

**+ means: resistant**  
**o means: limited resistance**  
**- means: not resistant**

